



**GHS SERIES
 FLEXIBLE SEAL
 HEAVY DUTY STANDARD
 STAINLESS STEEL ROTARY
 GEAR PUMP**

This heavy duty series with internal “wetted” parts of 316 Stainless Steel is ideal for handling corrosive applications. Superior rotor shaft support and an integral maintenance-free radial/thrust bearing, reduce deflection and wear. Due to the “galling” nature of stainless, extra internal clearance is necessary. A capacity correction table for liquids less than 750 SSU is available in Section 500.



SHOWN ^W/INTERCHANGE FOOT BRACKET

The GHS stainless series is designed for applications in the operating ranges noted below. These units are available with head and backhead jackets for temperature control, silicon carbide bushings for wear resistance, and numerous shaft seal options described on the following pages.

FEATURES

- 200 PSI CAPABILITY
- BALL BEARING THRUST CONTROL
- ROTOR END CLEARANCE EXTERNALLY ADJUSTABLE
- EXCEPTIONAL SEAL VERSATILITY WITH INTERNAL SEAL VENT
- COMPUTER PROFILED GEARING FOR QUIET OPERATION
- MULTIPLE PORT POSITIONS
- FLEXIBLE SEAL DESIGN ALLOWS FOR A VARIETY OF INDUSTRY STANDARD SEALS OR PACKING

OPERATING RANGE

- CAPACITY (GPM): (3 TO 295)
 [LPM] : [11 TO 1116]
- PRESSURE (PSI) : [0 TO 200]
 [BAR] : [0 TO 14]
- VISCOSITY (SSU) : (28 TO 2,000,000)
 [cSt] : [1 TO 440,000]
- TEMPERATURE (F) : (-30° TO 675°)
 [C] : [-34° TO 358°]

APPLICATIONS

- USE WITH ANY CLEAN LIQUID COMPATIBLE WITH 316 STAINLESS STEEL
- ★ BOOSTER SERVICE
 - ★ CIRCULATING
 - ★ FILTERING
 - ★ LUBRICATING
 - ★ TRANSFERRING

EXTERIOR	BACKH.D.	ROTOR & IDLER	HOUSING PORTS	BUSHING	IDLER PIN	SHAFT	SHAFT SEALING		ROTA-TION	INTERNAL RELIEF VALVE	
							MECH. SEAL	PACKING		MATERIAL	SETTING
316 STAIN. STEEL	CAST IRON	316 STAIN. STEEL	GHC 180° FLG. GHS 90° NPT	CARBON GRAPHITE	COATED 316 SST	STAIN. STEEL	CARBON, SIC, TEFLON ENC.	CARBON FIBER	C.W.	316 STAINLESS STEEL	75 PSI [5 BAR]

G H C 1 DC 9 - B
G H S 1 DC 9 - B
 | | | | | | | | | | | |
 GEAR DUTY DESIGN PORT SIZE HYD. SIZE SEAL STYLE

Standard Models

MODEL NUMBER		NOM. CAPACITY - SPEED				MAXIMUM				SHIPPING DATA	
		MAXIMUM		ALTERNATIVE		DIFF. PRESSURE - PSI [BAR]			TEMP.	Wt.	Vol.
		GPM [LPM]	RPM 60 Hz [50 HZ]	GPM [LPM]	RPM 60 Hz [50 HZ]	BELOW 38 SSU [4 cSt]	38 TO 100 SSU [21 cSt]	100 TO 250,000 SSU [55,000 cSt]	°F [°C]		
GHC 1 DC9-B ① ● ▸	GHS 1 DC9-B ① ● ● GHS 1 DC10-B ① ■ ■	9 [28]		6 [19]						32 [14,5]	2.9
GHC 1 DE9-B ① ● ▸	GHS 1 DE9-B ① ● ● GHS 1 DE10-B ① ■ ■	11 [35]		7 [22]						32 [14,5]	2.9
GHC 1-1/2 GC9-B ● ▸	GHS 1-1/2 GC9-B ● ● GHS 1-1/2 GC10-B ■ ■	16 [50]		10 [32]						63 [28,6]	2.9
	GHS 2 GC9-B ● ● GHS 2 GC10-B ■ ■									63 [28,6]	2.9
GHC 1-1/2 GF9-B ● ▸	GHS 1-1/2 GF9-B ● ● GHS 1-1/2 GF10-B ■ ■	23 [73]	1750 [1460]	15 [47]	1150 [960]					GHC ● 350 [177]	63 [28,6] 2.9
	GHS 2 GF9-B ● ● GHS 2 GF10-B ■ ■									GHS ● 400 [204]	63 [28,6] 2.9
GHC 1-1/2 GH9-B ● ▸	GHS 1-1/2 GH9-B ● ● GHS 1-1/2 GH10-B ■ ■	31 [98]		20 [63]		75 [5]	100 [7]	200 [14]		GHS ● 400 [204]	63 [28,6] 2.9
	GHS 2 GH9-B ● ● GHS 2 GH10-B ■ ■									■ 63 [28,6]	2.9
GHC 1-1/2 GJ9-B ● ▸	GHS 1-1/2 GJ9-B ● ● GHS 1-1/2 GJ10-B ■ ■	38 [120]		25 [79]						500 [260]	63 [28,6] 2.9
	GHS 2 GJ9-B ● ● GHS 2 GJ10-B ■ ■										63 [28,6] 2.9
	GHS 2 JG9-B ● ● GHS 2 JG10-B ■ ■	40 [126]	1150 [960]	30 [95]	870 [725]						161 [73,2] 5.3
GHC 3 JG9-B ● ▸	GHS 3 JG9-B ● ● GHS 3 JG10-B ■ ■										161 [73,2] 5.3
	GHS 2 JJ9-B ● ● GHS 2 JJ10-B ■ ■	56 [177]		42 [133]							161 [73,2] 5.3
GHC 3 JJ9-B ● ▸	GHS 3 JJ9-B ● ● GHS 3 JJ10-B ■ ■										161 [73,2] 5.3

STANDARD MODELS CONTINUED

① 3450 [2875] RPM PERMISSIBLE TO 1,000 SSU [220 cSt.] AND 100 PSI [7 BAR]

● MECHANICAL SEAL
■ PACKING/LIP SEAL

▸ PORTS ARE COMPATIBLE WITH 150# ANSI FLANGES. ALL OTHER PORTS ARE TAPPED NPT FOR ANSI PIPE. OPTIONAL [DIN] FLANGES OR TAPPED [BSP] PORTS ARE AVAILABLE FOR EXPORT MARKET.

NOTE: RECOMMENDED PORT SIZES ARE SHOWN IN **BOLDFACE**. EXAMPLE: **GHC 1 DC9-B**, **GHS 1 DC9-B**

THE GORMAN-RUPP COMPANY • MANSFIELD, OHIO

GORMAN-RUPP OF CANADA LIMITED • ST. THOMAS, ONTARIO, CANADA

Standard Models (Continued)

MODEL NUMBER		NOM. CAPACITY - SPEED				MAXIMUM				SHIPPING DATA	
		MAXIMUM		ALTERNATIVE		DIFF. PRESSURE - PSI [BAR]			TEMP.	Wt.	Vol.
		GPM [LPM]	RPM 60 Hz [50 HZ]	GPM [LPM]	RPM 60 Hz [50 HZ]	BELOW 38 SSU [4 cSt]	38 TO 100 SSU [21 cSt]	100 TO 250,000 SSU [55,000 cSt]	°F [°C]	LBS [KG]	CU. FT.
GHC	GHS 2 JL9-B ●	77 [243]	1150 [960]	58 [133]	870 [725]	75 [5]	100 [7]	200 [14]	161 [73,2]	5.3	
	GHS 2 JL10-B ■										
GHC 3 JL9-B ● †	GHS 3 JL9-B ●	107 [338]	960 [960]	81 [256]	580 [480]	75 [5]	100 [7]	200 [14]	161 [73,2]	5.3	
	GHS 3 JL10-B ■										
GHC 3 JP9-B ● †	GHS 2 JP9-B ●	132 [500]	960 [960]	80 [252]	580 [480]	75 [5]	100 [7]	200 [14]	161 [73,2]	5.3	
	GHS 2 JP10-B ■										
GHC 3 JP9-B ● †	GHS 3 JP9-B ●	165 [624]	960 [960]	99 [312]	580 [480]	75 [5]	100 [7]	200 [14]	161 [73,2]	5.3	
	GHS 3 JP10-B ■										
GHC	GHS 2 NK9-B ●	99 [375]	960 [960]	60 [189]	580 [480]	75 [5]	100 [7]	200 [14]	180 [81,8]	5.3	
	GHS 2 NK10-B ■										
	GHS 2-1/2 NK9-B ●										
	GHS 2-1/2 NK10-B ■										
	GHS 3 NK9-B ●										
	GHS 3 NK10-B ■										
	GHS 2 NM9-B ●										
	GHS 2 NM10-B ■										
	GHS 2-1/2 NM9-B ●										
	GHS 2-1/2 NM10-B ■										
	GHS 3 NM9-B ●										
	GHS 3 NM10-B ■										
GHC	GHS 2-1/2 NP9-B ●	172 [542]	960 [960]	115 [362]	580 [480]	75 [5]	100 [7]	200 [14]	180 [81,8]	5.3	
	GHS 2-1/2 NP10-B ■										
	GHS 3 NP9-B ●										
	GHS 3 NP10-B ■										
	GHS 2 RM9-B ●										
	GHS 2 RM10-B ■										
	GHS 2-1/2 RM9-B ● †										
	GHS 2-1/2 RM10-B ■ †										
	GHS 3 RM9-B ● †										
	GHS 3 RM10-B ■ †										
	GHS 4 RM9-B ● †										
	GHS 4 RM10-B ■ †										
GHC	GHS 3 RP9-B ● †	215 [678]	720 [600]	143 [451]	480 [400]	75 [5]	100 [7]	200 [14]	357 [162]	10.7	
	GHS 3 RP10-B ■ †										
GHC	GHS 4 RP9-B ● †	215 [678]	720 [600]	143 [451]	480 [400]	75 [5]	100 [7]	200 [14]	357 [162]	10.7	
	GHS 4 RP10-B ■ †										

STANDARD MODELS CONTINUED

- MECHANICAL SEAL
- PACKING/LIP SEAL

† PORTS ARE COMPATIBLE WITH 150# ANSI FLANGES. ALL OTHER PORTS ARE TAPPED NPT FOR ANSI PIPE. OPTIONAL [DIN] FLANGES OR TAPPED [BSP] PORTS ARE AVAILABLE FOR EXPORT MARKET.

NOTE: RECOMMENDED PORT SIZES ARE SHOWN IN **BOLDFACE**. EXAMPLE: **GHC 1 DC9-B, GHS 1 DC9-B**

THE GORMAN-RUPP COMPANY • MANSFIELD, OHIO
 GORMAN-RUPP OF CANADA LIMITED • ST. THOMAS, ONTARIO, CANADA

MODEL NUMBER		NOM. CAPACITY - SPEED				MAXIMUM				SHIPPING DATA	
		MAXIMUM		ALTERNATIVE		DIFF. PRESSURE - PSI [BAR]			TEMP.	Wt.	Vol.
		GPM [LPM]	RPM 60 Hz [50 HZ]	GPM [LPM]	RPM 60 Hz [50 HZ]	BELOW 38 SSU [4 cSt]	38 TO 100 SSU [21 cSt]	100 TO 250,000 SSU [55,000 cSt]	°F [°C]	LBS [KG]	CU. FT.
GHC	GHS										
	GHS 3 RR9-B ● ▸ GHS 3 RR10-B ■ ▸	255 [804]	720 [600]	170 [536]	480 [400]	75 [5]	100 [7]	200 [14]	GHS ● 400 [204] ■ 500 [260]	357 [162]	10.7
	GHS 4 RR9-B ● ▸ GHS 4 RR10-B ■ ▸			196 [618]						357 [162]	
	GHS 4 RS9-B ● ▸ GHS 4 RS10-B ■ ▸			295 [930]						357 [162]	

▸ PORTS ARE COMPATIBLE WITH 150# ANSI STAINLESS STEEL FLANGES. ALL OTHER PORTS ARE TAPPED NPT FOR ANSI PIPE. OPTIONAL [DIN] FLANGES OR TAPPED [BSP] PORTS AVAILABLE FOR EXPORT MARKET.

NOTE: RECOMMENDED PORT SIZES ARE SHOWN IN BOLDFACE. EXAMPLE: **GHC 1 DC9-B**, **GHS 1 DC9-B**

APPLICATION RECOMMENDATIONS:		
APPLICATION	OPTIONS REQUIRED (Select One From Each Row)	OPERATING LIMITATIONS
GHS ONLY HIGH TEMPERATURE	25U, 25V, OR 25W 35J – 35M (AS REQ'D) 40R, 70K 61H OR 65Q	TEMPERATURE: 675 °F MAX. PRESSURE: 200 PSI MAX.
GHS ONLY JACKETED	40K, 40W, 41U, 41W	LIMIT JACKET PRESSURE TO 150 PSI

NOTE: PROPER PUMP APPLICATION REQUIRES CONSIDERATION OF ADDITIONAL FACTORS. PLEASE REVIEW APPLICATION GUIDE IN SECTION 500 OR CONSULT THE FACTORY.

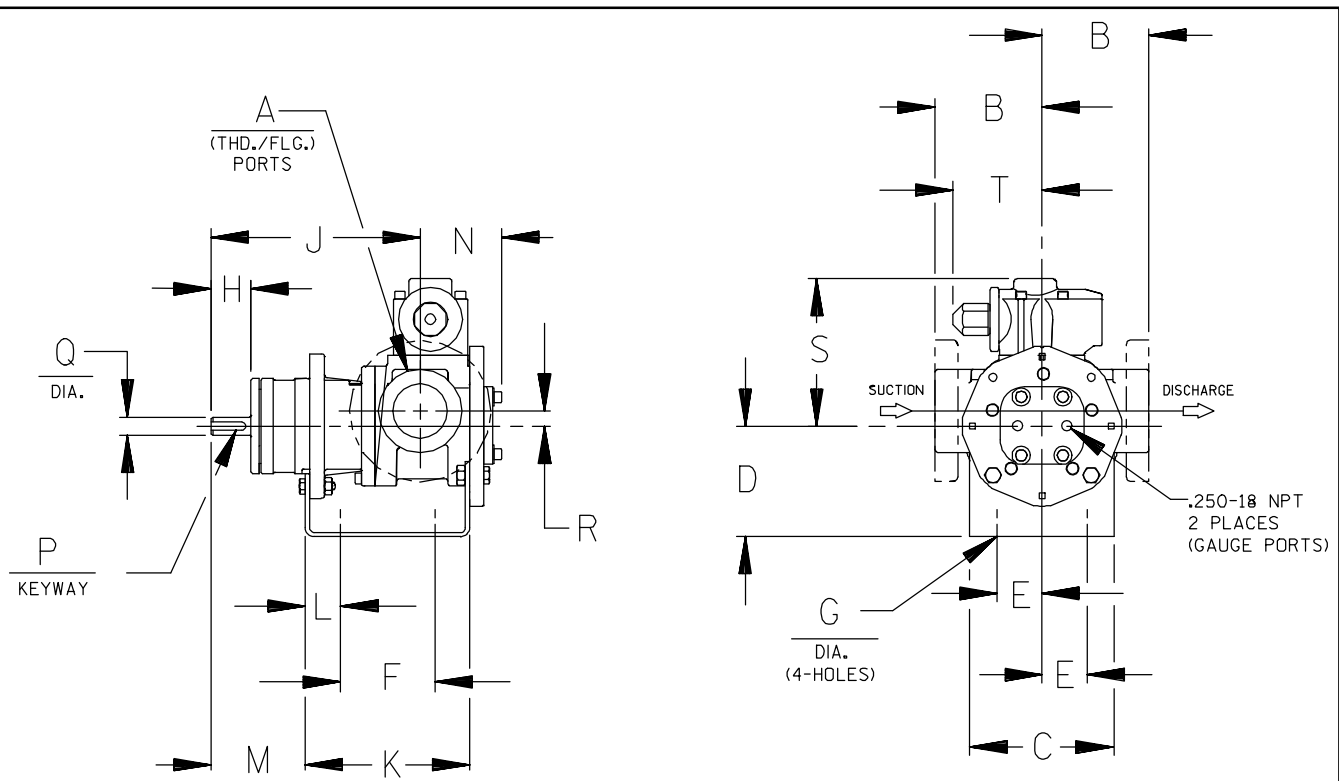

CAD FILE NO.: 16458B

MODEL NUMBERS	PUMP DIMENSIONS - INCHES [MILLIMETERS]																	
	A	B	C	D	E	F	G	H	J	K	L	M	N	P	Q	R	S	T
GHC D	1"	2.50 [64] †	4.00 [102]	3.50* [89]	1.62 [41]	3.12 [79]	.41 [10]	1.16 [30]	6.19 [157]	5.04 [128]	.76 [19]	2.62 [66]	2.74 [70]	.12 [3]	.50 [13]	.62 [16]	5.19 [132]	3.58 [91]
		4.00* [102] †		5.25 [133]										.75 [19]				
GHC G	1-1/2"	3.50 [89] †	5.88 [149]	3.50* [89]	1.62 [41]	4.00 [102]	.41 [10]	1.62 [41]	8.50 [216]	6.71 [170]	1.06 [27]	3.82 [97]	3.35 [85]	.19 [5]	.75 [19]	.62 [16]	6.00 [152]	3.62 [92]
		4.00* [102] †		4.50 [114]										5.25 [133]				
GHC J	3"	4.50 [114] †	6.88 [175]	4.50 [114]	2.88 [73]	4.25 [108]	.44 [11]	2.50 [64]	12.12 [308]	9.75 [248]	1.75 [44]	5.50 [140]	4.66 [118]	.25 [6]	1.00 [25]	1.12 [28]	9.06 [230]	6.75 [171]
		6.00* [152] †		5.25* [133]										6.25 [159]				

* STANDARD DIMENSION

† PORTS ARE COMPATIBLE WITH 125* OR 250* ANSI CAST IRON FLANGES. ALL OTHER PORTS ARE TAPPED NPT FOR ANSI PIPE. OPTIONAL (DIN) FLANGES OR TAPPED (BSP) PORTS AVAILABLE FOR EXPORT MARKET.

† 90° HOUSING



CAD FILE NO.: 16669G

MODEL NUMBERS	PUMP DIMENSIONS - INCHES [MILLIMETERS]														
	A	B	C	D	E	F	G	H	J	K	L	M	N	P	Q
GHS D	1"	2.50* [64]	4.00 [102]	3.50* [89]	1.62 [41]	5.50 [140]	.41 [10]	1.16 [30]	8.43 [214]	7.54 [192]	1.09 [28]	2.29 [58]	4.98 [127]	.12 [3] x .75 [19]	.50 [13]
		4.00 † [102]		5.25 [133]											
GHS G	1-1/2" 2"	3.50* [89]	4.88 [124]	3.50* [89]	1.62 [41]	8.00 [203]	.41 [10]	1.62 [41]	12.06 [306]	10.72 [272]	1.52 [39]	3.35 [85]	5.70 [145]	.19 [5] x 1.25 [32]	.75 [19]
		4.00 † [102]		5.25 [133]											
GHS J	2" 3"	4.50* [114]	6.88 [175]	5.25* [133]	2.88 [73]	10.00 [254]	.44 [11]	2.50 [64]	15.68 [398]	14.31 [363]	2.77 [70]	4.48 [114]	8.50 [216]	.25 [6] x 2.00 [51]	1.00 [25]
		6.00 † [152]		6.25 [159]											
GHS N	2" 3"	5.12 [130]	8.00 [203]	4.50 [114]	2.88 [73]	10.00 [254]	.44 [11]	2.58 [66]	16.37 [416]	15.14 [385]	2.69 [68]	4.56 [116]	8.72 [221]	.25 [6] x 2.00 [51]	1.12 [28]
				5.25* [133]											
GHS R	2"	6.50 [165]	10.50 [267]	7.00 [178]	3.75 [95]	13.75 [349]	.52 [13]	2.25 [57]	17.87 [454]	17.36 [441]	1.86 [47]	4.70 [119]	11.31 [287]	.38 [10] x 1.88 [48]	1.44 [37]
	2-1/2"														
	3"														
	4"	7.19 † [183]													

* STANDARD DIMENSION

† PORTS ARE COMPATIBLE WITH 150# OR 300# ANSISTAINLESS STEEL FLANGES. ALL OTHER PORTS ARE TAPPED NPT FOR ANSI PIPE. OPTIONAL (DIN) FLANGES OR TAPPED (BSP) PORTS AVAILABLE FOR EXPORT MARKET.

‡ 180° HOUSING

GHC/GHS

FOR GHC DRIVE OPTIONS

AND DIMENSIONS

SEE SECTION 540

FOR GHS DRIVE OPTIONS

AND DIMENSIONS

SEE SECTION 545

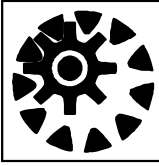

PERFORMANCE CURVES

SPEED VS. CAPACITY/HORSEPOWER

RM Hydraulic Size

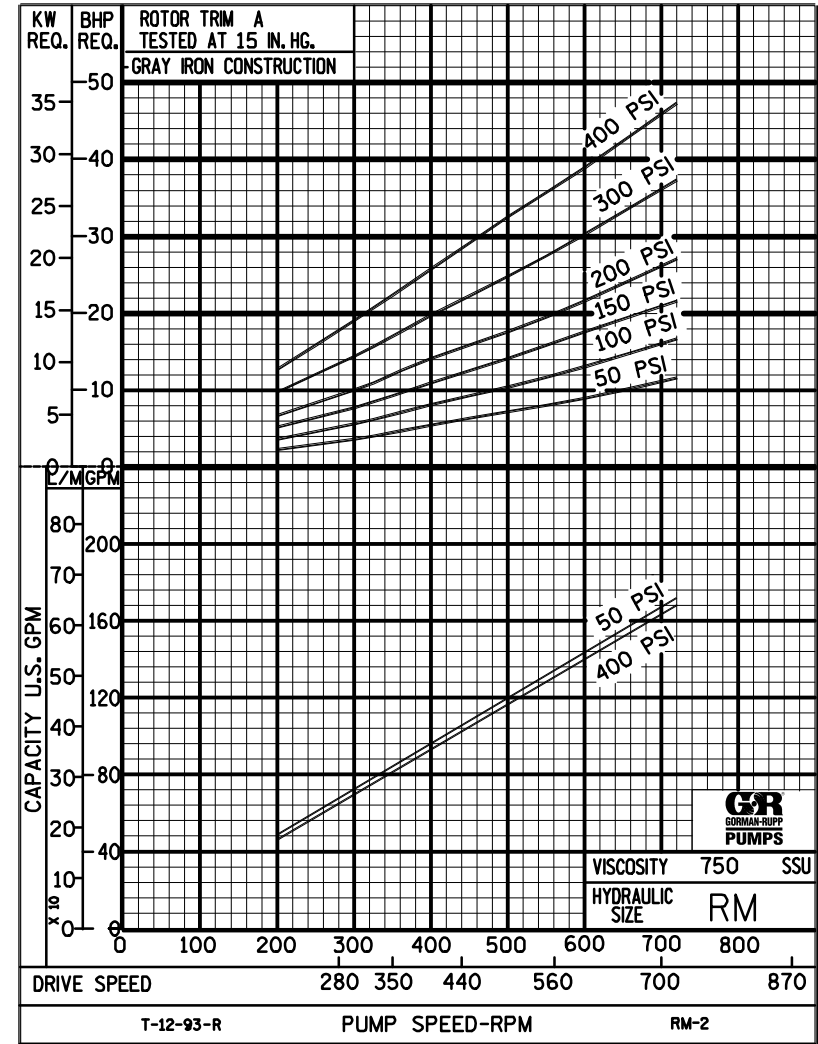
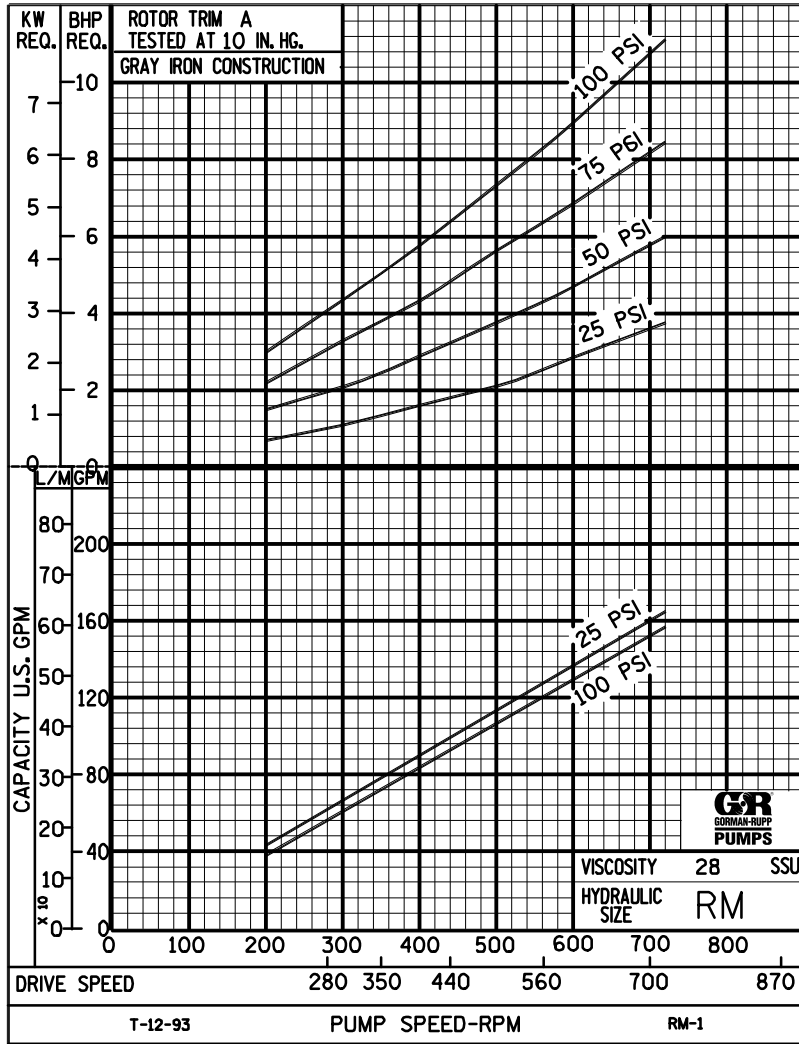

THE GORMAN-RUPP COMPANY • MANSFIELD, OHIO
 GORMAN-RUPP OF CANADA LIMITED • ST. THOMAS, ONTARIO, CANADA

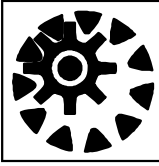

PERFORMANCE CURVES

SPEED VS. CAPACITY/HORSEPOWER

RM Hydraulic Size

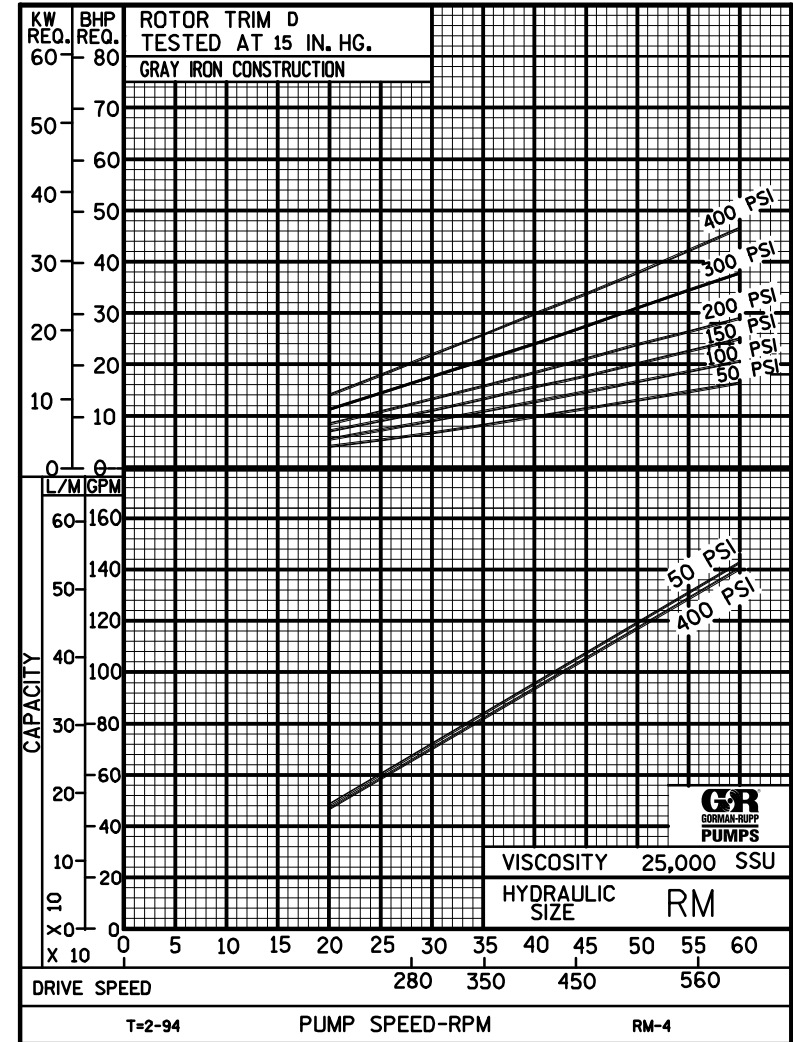
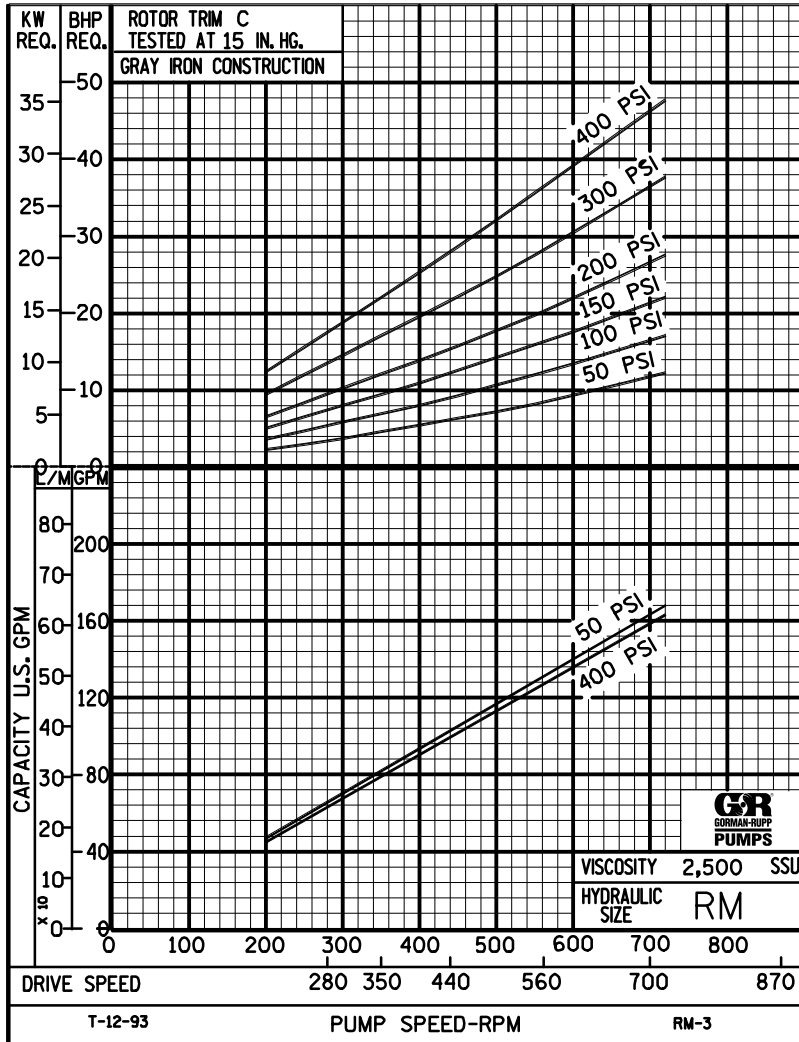

THE GORMAN-RUPP COMPANY • MANSFIELD, OHIO
 GORMAN-RUPP OF CANADA LIMITED • ST. THOMAS, ONTARIO, CANADA



RM

PUMP HYDRAULIC SIZE CHART

SEC. 500

Page 106

January 2010

172 GPM
720 RPM

NOMINAL		ROTOR TRIM	VISCOSITY (SSU)	N.I.P.R. (PSIA)	FRICTION PIPE LOSS (PSI/FT) (Based on Sch 40 Steel Pipe)					FULL BYPASS RELIEF VALVE PRESSURE (PSI)					CAPACITY (GPM) / H.P. REQUIRED									
CAP. GPM	SPEED RPM				PIPE DIAMETER					CRACKING PRESS. (PSI)					DIFFERENTIAL PRESSURE (PSI)									
					2"	2 1/2"	3"	4"	6"	LOW PRES R/V			HI PRES R/V		25	50	75	100	150	200	300	400		
172	720	STD	28	3.1	.21	.08	.03	.01	-	58	84	121	178		165	161	159	157						
			32		.22	.09	.03	.01	-						4.1	6.2	9.1	11						
			38	3.1	.23	.10	.03	.01	-	61	87	123	181		166	163	160	159	155					
			50		.26	.11	.04	.01	-						5.2	7.8	10	13	18					
			70	3.1	.29	.12	.04	.01	-	65	90	126	185	245	168	166	164	162	160	158				
			100		.32	.14	.05	.01	-						6.8	9.2	12	14	20	25				
			150	3.1	.35	.15	.05	.01	-	69	94	130	188	250	170	168	167	166	164	163	161	158		
			200		.38	.16	.06	.02	-						7.8	10	13	15	21	26	36	47		
			300	3.1	.43	.19	.07	.02	-	74	100	134	193	256	171	170	170	169	168	166	166	165		
			500		.50	.22	.06	.02	-						8.9	11	14	16	22	27	37	47		
		750	3.2	.41	.20	.08	.03	.01	78	104	137	197	260	172	172	172	171	170	169	169	168			
		1,000		.55	.27	.11	.04	.01						9.4	12	14	17	22	27	37	48			
		2,000	3.4	1.10	.54	.23	.08	.01	85	111	143	203	269	169	168	168	168	167	167	165	163			
		3,500		1.92	.94	.40	.13	.03						11	13	16	18	23	28	38	49			
		5,000	3.6	2.74	1.35	.56	.19	.04	89	115	147	207	273	169	169	168	168	167	167	166	164			
		7,500		4.11	2.02	.85	.29	.06						11	14	17	19	24	29	39	50			
		10,000	3.9	5.48	2.69	1.13	.38	.07	93	119	150	211	278	170	169	169	168	168	168	167	165			
		15,000		8.22	4.04	1.69	.57	.11						13	15	17	21	26	31	41	52			
		20,000																						
		25,000																						
50,000																								
75,000																								
100,000																								
150,000																								
200,000																								
250,000																								

(NOTE) For speeds not shown on the pump hydraulic charts, consult factory.



RM

PUMP HYDRAULIC SIZE CHART

SEC. 500

Page 107
January 2010

153 GPM
640 RPM

NOMINAL		ROTOR TRIM	VISCOSITY (SSU)	N.I.P.R. (PSIA)	FRICTION PIPE LOSS (PSI/FT) <small>(Based on Sch 40 Steel Pipe)</small>					FULL BYPASS RELIEF VALVE PRESSURE (PSI)					CAPACITY (GPM) / H.P. REQUIRED										
CAP. GPM	SPEED RPM				PIPE DIAMETER					CRACKING PRESS. (PSI)					DIFFERENTIAL PRESSURE (PSI)										
					2"	2 1/2"	3"	4"	6"	LOW PRES R/V		HI PRES R/V			MEDIUM DUTY AND HEAVY DUTY				HEAVY DUTY ONLY						
						50	75	100	150	200	25	50	75	100	150	200	300	400							
153	640	STD	28	2.5	.16	.07	.02	.01	-	57	84	120	178		145	142	139	137							
			32		.17	.07	.02	.01	-							3.3	6.1	7.9	10						
			38	2.5	.19	.08	.03	.01	-	60	86	122	180			146	144	141	140	137					
			50		.20	.09	.03	.01	-							4.5	6.8	9.1	11	16					
			70	2.5	.23	.10	.03	.01	-	63	89	124	183	242		148	146	144	143	141	139				
			100		.25	.11	.04	.01	-							5.9	8.1	10	12	17	23				
			150	2.5	.28	.12	.04	.01	-							150	149	148	147	145	144	142	139		
			200		.31	.13	.05	.01	-	66	93	127	186	246		6.7	9.2	11	13	18	23	32	41		
			300	2.5	.35	.15	.05	.01	-							152	151	150	150	149	148	146	145		
			500		.41	.12	.05	.02	-	72	98	131	190	251		7.8	10	12	14	19	24	33	42		
		750	2.6	.36	.18	.07	.03	-							153	152	152	152	151	150	150	149			
		1,000		.48	.24	.10	.03	.01	75	101	134	193	254		7.9	10	12	14	19	24	33	42			
		2,000	2.7	.97	.47	.20	.07	.01							151	150	150	149	149	148	147	146			
		3,500		1.69	.83	.35	.12	.02	82	110	139	199	260		8.8	11	13	15	20	24	33	43			
		5,000	2.9	2.42	1.19	.50	.17	.03							151	150	150	150	149	148	147	146			
		7,500		3.63	1.78	.75	.25	.05	86	112	142	202	264		10	13	15	16	21	26	35	45			
		10,000	3.2	4.83	2.37	1.00	.34	.07							151	151	150	150	150	149	148	147			
		15,000		7.25	3.56	1.49	.50	.10	89	115	145	205	268		12	14	16	18	23	28	36	47			
		20,000	3.5	9.67	4.75	1.99	.67	.13							152	151	151	150	150	150	149	148			
		25,000		12.1	5.94	2.49	.84	.16	92	118	147	207	270		14	16	18	20	25	30	39	50			
50,000	"D"																								
75,000																									
100,000																									
150,000																									
200,000																									
250,000																									

(NOTE) For speeds not shown on the pump hydraulic charts, consult factory.



RM

PUMP HYDRAULIC SIZE CHART

SEC. 500

Page 108
January 2010

125 GPM
520 RPM

NOMINAL		ROTOR TRIM	VISCOSITY (SSU)	N.I.P.R. (PSIA)	FRICTION PIPE LOSS (PSI/FT) <small>(Based on Sch 40 Steel Pipe)</small>					FULL BYPASS RELIEF VALVE PRESSURE (PSI)					CAPACITY (GPM) / H.P. REQUIRED							
CAP. GPM	SPEED RPM				PIPE DIAMETER					CRACKING PRESS. (PSI)					DIFFERENTIAL PRESSURE (PSI)							
					2"	2 1/2"	3"	4"	6"	LOW PRES R/V		HI PRES R/V			MEDIUM DUTY AND HEAVY DUTY				HEAVY DUTY ONLY			
						50	75	100	150	200	25	50	75	100	150	200	300	400				
125	520	STD	28	1.9	.11	.05	.02	-	-	55	83	119	176	116	113	112	109					
			32		.12	.05	.02	-	-							2.3	4.1	7.1	9.8			
			38	1.9	.13	.05	.02	.01	-	57	85	121	177	118	115	113	111	108				
			50		.15	.06	.02	.01	-							3.5	5.1	7.9	10	14		
			70	1.9	.16	.07	.02	.01	-	60	88	123	180	236	120	118	117	115	113	110		
			100		.18	.08	.03	.01	-							4.5	6.1	8.9	11	15	18	
			150	1.9	.21	.09	.03	.01	-	64	91	125	182	239	122	121	120	119	117	115	113	111
			200		.22	.10	.03	.01	-							5.2	6.8	9.3	11	15	18	26
			300	1.9	.25	.11	.02	.01	-	68	95	128	185	242	124	123	122	121	120	119	118	117
			500		.20	.10	.04	.01	-							5.6	7.4	9.4	11	15	18	26
		750	2.0	.30	.15	.06	.02	-	72	98	130	187	244	125	124	124	123	123	122	122	121	
		1,000		.40	.20	.08	.03	.01							5.9	7.6	9.6	11	15	18	26	34
		2,000	2.3	.81	.40	.17	.06	.01	78	104	134	191	249	123	122	122	121	120	120	118	118	
		3,500		1.41	.69	.29	.10	.02							6.7	8.4	11	12	16	19	26	34
		5,000	2.6	2.01	.99	.42	.14	.03	81	107	136	194	252	123	123	122	122	121	121	119	119	
		7,500		3.02	1.48	.62	.21	.04							8.4	10	12	14	17	21	28	35
		10,000	2.9	4.03	1.98	.83	.28	.05	85	110	139	196	254	124	123	123	122	122	122	120	120	
		15,000		6.04	2.97	1.25	.42	.08							10	12	14	16	19	23	30	37
		20,000	3.2	8.06	3.96	1.66	.56	.11	87	112	140	197	256	124	124	123	123	123	123	122	121	
		25,000		10.1	4.95	2.08	.70	.14							12	13	16	17	21	25	32	39
50,000	4.6	20.1	9.90	4.15	1.40	.27	93	117	143	202	260	124	124	123	123	123	123	122	121			
75,000		30.2	14.8	6.23	2.10	.41							16	18	20	22	26	30	38	45		
100,000																						
150,000																						
200,000																						
250,000																						

(NOTE) For speeds not shown on the pump hydraulic charts, consult factory.



RM

PUMP HYDRAULIC SIZE CHART

SEC. 500

Page 109

January 2010

85 GPM
350 RPM

NOMINAL		ROTOR TRIM	VISCOSITY (SSU)	N.I.P.R. (PSIA)	FRICTION PIPE LOSS (PSI/FT) (Based on Sch 40 Steel Pipe)					FULL BYPASS RELIEF VALVE PRESSURE (PSI)					CAPACITY (GPM) / H.P. REQUIRED												
CAP. GPM	SPEED RPM				PIPE DIAMETER					CRACKING PRESS. (PSI)					DIFFERENTIAL PRESSURE (PSI)												
					2"	2 1/2"	3"	4"	6"	LOW PRES R/V		HI PRES R/V			MEDIUM DUTY AND HEAVY DUTY				HEAVY DUTY ONLY								
85	350	STD	28	1.3	.05	.02	.01	-	-	54	81	117	171		78	74	72	70									
			32		.06	.02	.01	-	-							1.3	3.1	4.1	5.2								
			38	1.3	.06	.03	.01	-	-	55	82	118	172		79	75	74	72	70								
			50		.07	.03	.01	-	-							2.1	3.1	4.8	6.1	7.9							
			70	1.3	.08	.04	.01	-	-	58	85	119	173	227		80	78	77	76	74	73						
			100		.09	.04	.01	-	-							2.8	3.8	5.3	6.6	8.6	11						
			150	1.3	.11	.05	.02	-	-	61	87	121	174	228		82	80	79	79	78	78	77	76				
			200		.12	.05	.02	-	-							3.3	4.1	5.8	6.9	9.1	12	17	22				
			300	1.3	.13	.04	.02	.01	-	65	90	123	176	230		83	82	81	81	80	80	80	80	79			
			500		.14	.07	.03	.01	-							3.4	4.2	5.9	7.1	9.3	12	17	22				
		750	1.4	.21	.10	.04	.01	-	67	93	124	177	231		84	83	83	82	82	82	82	81	81				
		1,000		.27	.13	.06	.02	-							3.4	4.3	6.0	7.2	9.4	12	17	22					
		2,000	1.6	.55	.27	.11	.04	.01	73	97	127	179	233		83	82	82	81	81	80	80	80	79				
		3,500		.96	.47	.20	.07	.01							3.6	5.1	6.2	7.9	9.8	12	17	22					
		5,000	1.8	1.37	.67	.28	.10	.02	75	100	128	181	235		83	83	83	82	82	81	80	80					
		7,500		2.05	1.01	.42	.14	.03							4.6	5.8	7.1	9.1	11	13	19	23					
		10,000	2.2	2.74	1.35	.56	.19	.04	78	102	130	182	236		83	83	82	82	82	82	81	81					
		15,000		4.11	2.02	.85	.29	.06							5.6	7.1	8.2	10	12	14	20	25					
		20,000	2.6	5.48	2.69	1.13	.38	.07	80	104	131	183	237		84	83	83	83	83	82	82	82					
		25,000		6.85	3.36	1.41	.48	.09							6.8	8.1	9.5	11	13	16	21	26					
50,000	4.1	13.7	6.73	2.82	.95	.18	85	108	133	185	239		84	83	83	83	83	82	82	82							
75,000		20.6	10.0	4.23	1.43	.28							10	12	14	15	17	19	25	30							
100,000	5.6	27.4	13.5	5.64	1.90	.37	87	110	134	186	240		84	83	83	83	83	82	82	82							
150,000		41.0	20.2	8.47	2.86	.55							13	15	17	18	22	24	30	35							
200,000	7.5	54.8	27.0	11.3	3.81	.74	89	112	135	187	241		84	83	83	83	83	82	82	82							
250,000		68.5	33.7	14.1	4.76	.92							15	17	19	20	26	27	33	39							

(NOTE) For speeds not shown on the pump hydraulic charts, consult factory.