



**GHS SERIES
 FLEXIBLE SEAL
 HEAVY DUTY STANDARD
 STAINLESS STEEL ROTARY
 GEAR PUMP**

This heavy duty series with internal “wetted” parts of 316 Stainless Steel is ideal for handling corrosive applications. Superior rotor shaft support and an integral maintenance-free radial/thrust bearing, reduce deflection and wear. Due to the “galling” nature of stainless, extra internal clearance is necessary. A capacity correction table for liquids less than 750 SSU is available in Section 500.



SHOWN ^W/INTERCHANGE FOOT BRACKET

The GHS stainless series is designed for applications in the operating ranges noted below. These units are available with head and backhead jackets for temperature control, silicon carbide bushings for wear resistance, and numerous shaft seal options described on the following pages.

FEATURES

- 200 PSI CAPABILITY
- BALL BEARING THRUST CONTROL
- ROTOR END CLEARANCE EXTERNALLY ADJUSTABLE
- EXCEPTIONAL SEAL VERSATILITY WITH INTERNAL SEAL VENT
- COMPUTER PROFILED GEARING FOR QUIET OPERATION
- MULTIPLE PORT POSITIONS
- FLEXIBLE SEAL DESIGN ALLOWS FOR A VARIETY OF INDUSTRY STANDARD SEALS OR PACKING

OPERATING RANGE

- CAPACITY (GPM): (3 TO 295)
 [LPM] : [11 TO 1116]
- PRESSURE (PSI) : [0 TO 200]
 [BAR] : [0 TO 14]
- VISCOSITY (SSU) : (28 TO 2,000,000)
 [cSt] : [1 TO 440,000]
- TEMPERATURE (F) : (-30° TO 675°)
 [C] : [-34° TO 358°]

APPLICATIONS

- USE WITH ANY CLEAN LIQUID COMPATIBLE WITH 316 STAINLESS STEEL
- ★ BOOSTER SERVICE
 - ★ CIRCULATING
 - ★ FILTERING
 - ★ LUBRICATING
 - ★ TRANSFERRING

EXTERIOR	BACKH.D	ROTOR & IDLER	HOUSING PORTS	BUSHING	IDLER PIN	SHAFT	SHAFT SEALING		ROTA-TION	INTERNAL RELIEF VALVE	
							MECH. SEAL	PACKING		MATERIAL	SETTING
316 STAIN. STEEL	CAST IRON	316 STAIN. STEEL	GHC 180° FLG. GHS 90° NPT	CARBON GRAPHITE	COATED 316 SST	STAIN. STEEL	CARBON, SIC, TEFLON ENC.	CARBON FIBER	C.W.	316 STAINLESS STEEL	75 PSI [5 BAR]

G H C 1 DC 9 - B
G H S 1 DC 9 - B
 | | | | | | | | | | | |
 GEAR DUTY DESIGN PORT SIZE HYD. SIZE SEAL STYLE

Standard Models

MODEL NUMBER		NOM. CAPACITY - SPEED				MAXIMUM				SHIPPING DATA	
		MAXIMUM		ALTERNATIVE		DIFF. PRESSURE - PSI [BAR]			TEMP.	Wt.	Vol.
		GPM [LPM]	RPM 60 Hz [50 HZ]	GPM [LPM]	RPM 60 Hz [50 HZ]	BELOW 38 SSU [4 cSt]	38 TO 100 SSU [21 cSt]	100 TO 250,000 SSU [55,000 cSt]	°F [°C]		
GHC 1 DC9-B ① ● ▸	GHS 1 DC9-B ① ● ● GHS 1 DC10-B ① ■ ■	9 [28]		6 [19]						32 [14,5]	2.9
GHC 1 DE9-B ① ● ● ▸	GHS 1 DE9-B ① ● ● ● GHS 1 DE10-B ① ■ ■ ■	11 [35]		7 [22]						32 [14,5]	2.9
GHC 1-1/2 GC9-B ● ● ▸	GHS 1-1/2 GC9-B ● ● ● GHS 1-1/2 GC10-B ■ ■ ■	16 [50]		10 [32]						63 [28,6]	2.9
	GHS 2 GC9-B ● ● ● GHS 2 GC10-B ■ ■ ■									63 [28,6]	2.9
GHC 1-1/2 GF9-B ● ● ▸	GHS 1-1/2 GF9-B ● ● ● ● GHS 1-1/2 GF10-B ■ ■ ■ ■	23 [73]	1750 [1460]	15 [47]	1150 [960]					GHC ● 63 [28,6] 2.9 350 [177] 63 [28,6] 2.9	
	GHS 2 GF9-B ● ● ● ● GHS 2 GF10-B ■ ■ ■ ■									GHS ● 63 [28,6] 2.9 400 [204] 63 [28,6] 2.9	
GHC 1-1/2 GH9-B ● ● ▸	GHS 1-1/2 GH9-B ● ● ● ● GHS 1-1/2 GH10-B ■ ■ ■ ■	31 [98]		20 [63]		75 [5]	100 [7]	200 [14]		63 [28,6] 2.9 63 [28,6] 2.9	
	GHS 2 GH9-B ● ● ● ● GHS 2 GH10-B ■ ■ ■ ■									63 [28,6] 2.9	
GHC 1-1/2 GJ9-B ● ● ▸	GHS 1-1/2 GJ9-B ● ● ● ● GHS 1-1/2 GJ10-B ■ ■ ■ ■	38 [120]		25 [79]						63 [28,6] 2.9	
	GHS 2 GJ9-B ● ● ● ● GHS 2 GJ10-B ■ ■ ■ ■									63 [28,6] 2.9	
	GHS 2 JG9-B ● ● ● ● GHS 2 JG10-B ■ ■ ■ ■	40 [126]	1150 [960]	30 [95]	870 [725]					161 [73,2] 5.3	
GHC 3 JG9-B ● ● ▸	GHS 3 JG9-B ● ● ● ● GHS 3 JG10-B ■ ■ ■ ■									161 [73,2] 5.3	
	GHS 2 JJ9-B ● ● ● ● GHS 2 JJ10-B ■ ■ ■ ■	56 [177]		42 [133]						161 [73,2] 5.3	
GHC 3 JJ9-B ● ● ▸	GHS 3 JJ9-B ● ● ● ● GHS 3 JJ10-B ■ ■ ■ ■									161 [73,2] 5.3	

STANDARD MODELS CONTINUED

① 3450 [2875] RPM PERMISSIBLE TO 1,000 SSU [220 cSt.] AND 100 PSI [7 BAR]
 ● MECHANICAL SEAL ▸ PORTS ARE COMPATIBLE WITH 150# ANSI FLANGES. ALL OTHER PORTS ARE TAPPED NPT FOR ANSI PIPE. OPTIONAL [DIN] FLANGES OR TAPPED [BSP] PORTS ARE AVAILABLE FOR EXPORT MARKET.
 ■ PACKING/LIP SEAL

NOTE: RECOMMENDED PORT SIZES ARE SHOWN IN **BOLDFACE**. EXAMPLE: **GHC 1 DC9-B, GHS 1 DC9-B**

THE GORMAN-RUPP COMPANY • MANSFIELD, OHIO
 GORMAN-RUPP OF CANADA LIMITED • ST. THOMAS, ONTARIO, CANADA

Standard Models (Continued)

MODEL NUMBER		NOM. CAPACITY - SPEED				MAXIMUM				SHIPPING DATA	
		MAXIMUM		ALTERNATIVE		DIFF. PRESSURE - PSI [BAR]			TEMP.	Wt.	Vol.
		GPM [LPM]	RPM 60 Hz [50 HZ]	GPM [LPM]	RPM 60 Hz [50 HZ]	BELOW 38 SSU [4 cSt]	38 TO 100 SSU [21 cSt]	100 TO 250,000 SSU [55,000 cSt]	°F [°C]	LBS [KG]	CU. FT.
GHC	GHS 2 JL9-B ●	77 [243]	1150 [960]	58 [133]	870 [725]	75 [5]	100 [7]	200 [14]	161 [73,2]	5.3	
	GHS 2 JL10-B ■										
GHC 3 JL9-B ● †	GHS 3 JL9-B ●	107 [338]	960 [960]	81 [256]	580 [480]	75 [5]	100 [7]	200 [14]	161 [73,2]	5.3	
	GHS 3 JL10-B ■										
GHC 3 JP9-B ● †	GHS 2 JP9-B ●	132 [500]	960 [960]	80 [252]	580 [480]	75 [5]	100 [7]	200 [14]	161 [73,2]	5.3	
	GHS 2 JP10-B ■										
GHC 3 JP9-B ● †	GHS 3 JP9-B ●	165 [624]	960 [960]	99 [312]	580 [480]	75 [5]	100 [7]	200 [14]	161 [73,2]	5.3	
	GHS 3 JP10-B ■										
GHC	GHS 2 NK9-B ●	99 [375]	960 [960]	60 [189]	580 [480]	75 [5]	100 [7]	200 [14]	180 [81,8]	5.3	
	GHS 2 NK10-B ■										
GHC 3 NK9-B ●	GHS 2-1/2 NK9-B ●	132 [500]	960 [960]	80 [252]	580 [480]	75 [5]	100 [7]	200 [14]	180 [81,8]	5.3	
	GHS 2-1/2 NK10-B ■										
GHC 3 NK9-B ●	GHS 3 NK9-B ●	172 [542]	960 [960]	115 [362]	580 [480]	75 [5]	100 [7]	200 [14]	180 [81,8]	5.3	
	GHS 3 NK10-B ■										
GHC 3 NM9-B ●	GHS 2 NM9-B ●	215 [678]	720 [600]	143 [451]	480 [400]	75 [5]	100 [7]	200 [14]	180 [81,8]	5.3	
	GHS 2 NM10-B ■										
GHC 3 NM9-B ●	GHS 2-1/2 NM9-B ●	165 [624]	720 [600]	143 [451]	480 [400]	75 [5]	100 [7]	200 [14]	180 [81,8]	5.3	
	GHS 2-1/2 NM10-B ■										
GHC 3 NM9-B ●	GHS 3 NM9-B ●	172 [542]	720 [600]	143 [451]	480 [400]	75 [5]	100 [7]	200 [14]	180 [81,8]	5.3	
	GHS 3 NM10-B ■										
GHC 3 NP9-B ●	GHS 2-1/2 NP9-B ●	172 [542]	720 [600]	143 [451]	480 [400]	75 [5]	100 [7]	200 [14]	180 [81,8]	5.3	
	GHS 2-1/2 NP10-B ■										
GHC 3 NP9-B ●	GHS 3 NP9-B ●	215 [678]	720 [600]	143 [451]	480 [400]	75 [5]	100 [7]	200 [14]	180 [81,8]	5.3	
	GHS 3 NP10-B ■										
GHC 3 RM9-B ●	GHS 2 RM9-B ●	172 [542]	720 [600]	143 [451]	480 [400]	75 [5]	100 [7]	200 [14]	357 [162]	10.7	
	GHS 2 RM10-B ■										
GHC 3 RM9-B ●	GHS 2-1/2 RM9-B ● †	215 [678]	720 [600]	143 [451]	480 [400]	75 [5]	100 [7]	200 [14]	357 [162]	10.7	
	GHS 2-1/2 RM10-B ■ †										
GHC 3 RM9-B ●	GHS 3 RM9-B ● †	215 [678]	720 [600]	143 [451]	480 [400]	75 [5]	100 [7]	200 [14]	357 [162]	10.7	
	GHS 3 RM10-B ■ †										
GHC 3 RP9-B ●	GHS 4 RM9-B ● †	215 [678]	720 [600]	143 [451]	480 [400]	75 [5]	100 [7]	200 [14]	357 [162]	10.7	
	GHS 4 RM10-B ■ †										
GHC 3 RP9-B ●	GHS 3 RP9-B ● †	215 [678]	720 [600]	143 [451]	480 [400]	75 [5]	100 [7]	200 [14]	357 [162]	10.7	
	GHS 3 RP10-B ■ †										
GHC 3 RP9-B ●	GHS 4 RP9-B ● †	215 [678]	720 [600]	143 [451]	480 [400]	75 [5]	100 [7]	200 [14]	357 [162]	10.7	
	GHS 4 RP10-B ■ †										

STANDARD MODELS CONTINUED

● MECHANICAL SEAL
■ PACKING/LIP SEAL

† PORTS ARE COMPATIBLE WITH 150# ANSI FLANGES. ALL OTHER PORTS ARE TAPPED NPT FOR ANSI PIPE. OPTIONAL [DIN] FLANGES OR TAPPED [BSP] PORTS ARE AVAILABLE FOR EXPORT MARKET.

NOTE: RECOMMENDED PORT SIZES ARE SHOWN IN **BOLDFACE**. EXAMPLE: **GHC 1 DC9-B, GHS 1 DC9-B**

THE GORMAN-RUPP COMPANY • MANSFIELD, OHIO
GORMAN-RUPP OF CANADA LIMITED • ST. THOMAS, ONTARIO, CANADA

MODEL NUMBER		NOM. CAPACITY - SPEED				MAXIMUM				SHIPPING DATA	
		MAXIMUM		ALTERNATIVE		DIFF. PRESSURE - PSI [BAR]			TEMP.	Wt.	Vol.
		GPM [LPM]	RPM 60 Hz [50 HZ]	GPM [LPM]	RPM 60 Hz [50 HZ]	BELOW 38 SSU [4 cSt]	38 TO 100 SSU [21 cSt]	100 TO 250,000 SSU [55,000 cSt]	°F [°C]	LBS [KG]	CU. FT.
GHC	GHS										
	GHS 3 RR9-B ● ▸ GHS 3 RR10-B ■ ▸	255 [804]	720 [600]	170 [536]	480 [400]	75 [5]	100 [7]	200 [14]	GHS ● 400 [204] ■ 500 [260]	357 [162]	10.7
	GHS 4 RR9-B ● ▸ GHS 4 RR10-B ■ ▸			196 [618]						357 [162]	
	GHS 4 RS9-B ● ▸ GHS 4 RS10-B ■ ▸			295 [930]						357 [162]	

▸ PORTS ARE COMPATIBLE WITH 150# ANSI STAINLESS STEEL FLANGES. ALL OTHER PORTS ARE TAPPED NPT FOR ANSI PIPE. OPTIONAL [DIN] FLANGES OR TAPPED [BSP] PORTS AVAILABLE FOR EXPORT MARKET.

NOTE: RECOMMENDED PORT SIZES ARE SHOWN IN BOLDFACE. EXAMPLE: **GHC 1 DC9-B, GHS 1 DC9-B**

APPLICATION RECOMMENDATIONS:		
APPLICATION	OPTIONS REQUIRED (Select One From Each Row)	OPERATING LIMITATIONS
GHS ONLY HIGH TEMPERATURE	25U, 25V, OR 25W 35J – 35M (AS REQ'D) 40R, 70K 61H OR 65Q	TEMPERATURE: 675 °F MAX. PRESSURE: 200 PSI MAX.
GHS ONLY JACKETED	40K, 40W, 41U, 41W	LIMIT JACKET PRESSURE TO 150 PSI

NOTE: PROPER PUMP APPLICATION REQUIRES CONSIDERATION OF ADDITIONAL FACTORS. PLEASE REVIEW APPLICATION GUIDE IN SECTION 500 OR CONSULT THE FACTORY.

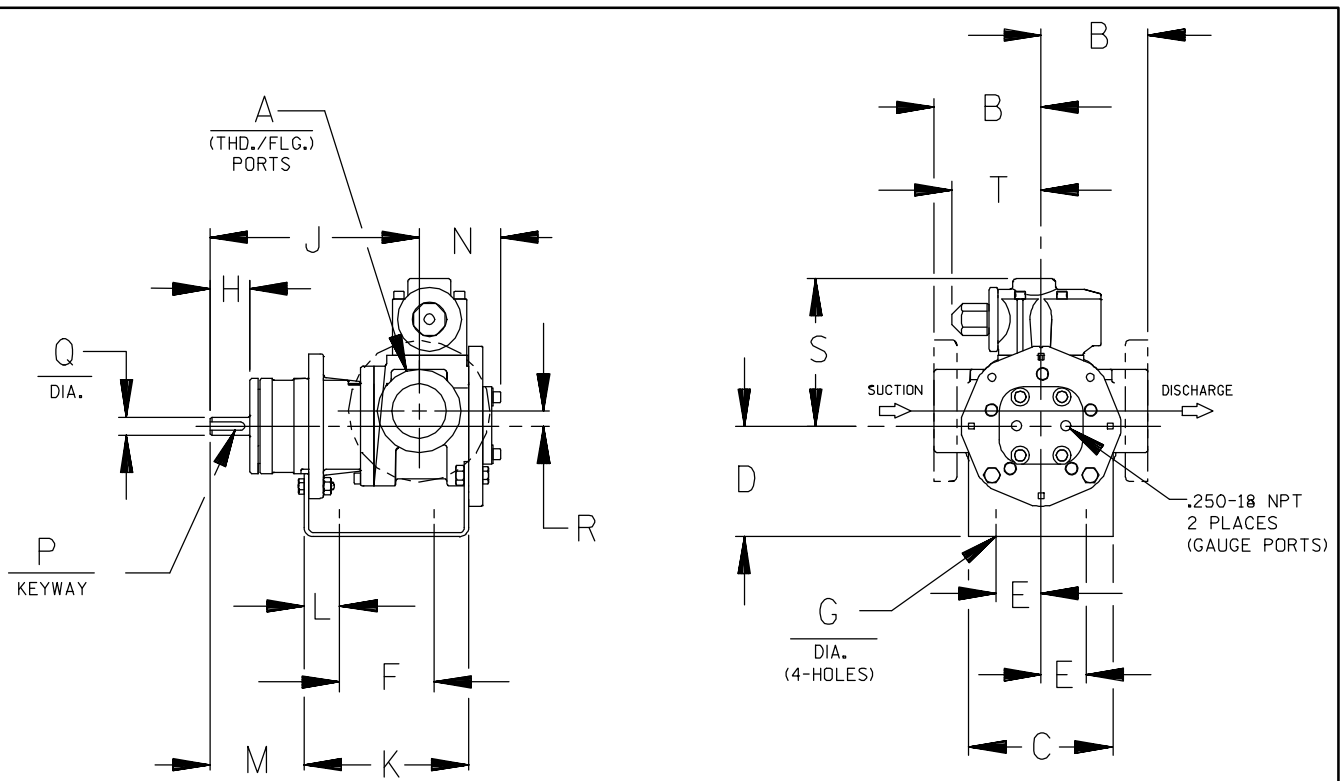

CAD FILE NO.: 16458B

MODEL NUMBERS	PUMP DIMENSIONS - INCHES [MILLIMETERS]																	
	A	B	C	D	E	F	G	H	J	K	L	M	N	P	Q	R	S	T
GHC D	1"	2.50 [64] †	4.00 [102]	3.50* [89]	1.62 [41]	3.12 [79]	.41 [10]	1.16 [30]	6.19 [157]	5.04 [128]	.76 [19]	2.62 [66]	2.74 [70]	.12 [3]	.50 [13]	.62 [16]	5.19 [132]	3.58 [91]
		4.00* [102] †		5.25 [133]										.75 [19]				
GHC G	1-1/2"	3.50 [89] †	5.88 [149]	3.50* [89]	1.62 [41]	4.00 [102]	.41 [10]	1.62 [41]	8.50 [216]	6.71 [170]	1.06 [27]	3.82 [97]	3.35 [85]	.19 [5]	.75 [19]	.62 [16]	6.00 [152]	3.62 [92]
		4.00* [102] †		4.50 [114]										5.25 [133]				
GHC J	3"	4.50 [114] †	6.88 [175]	4.50 [114]	2.88 [73]	4.25 [108]	.44 [11]	2.50 [64]	12.12 [308]	9.75 [248]	1.75 [44]	5.50 [140]	4.66 [118]	.25 [6]	1.00 [25]	1.12 [28]	9.06 [230]	6.75 [171]
		6.00* [152] †		5.25* [133]										6.25 [159]				

* STANDARD DIMENSION

† PORTS ARE COMPATIBLE WITH 125* OR 250* ANSI CAST IRON FLANGES. ALL OTHER PORTS ARE TAPPED NPT FOR ANSI PIPE. OPTIONAL (DIN) FLANGES OR TAPPED (BSP) PORTS AVAILABLE FOR EXPORT MARKET.

† 90° HOUSING



CAD FILE NO.: 16669G

MODEL NUMBERS	PUMP DIMENSIONS - INCHES [MILLIMETERS]															
	A	B	C	D	E	F	G	H	J	K	L	M	N	P	Q	
GHS D	1"	2.50* [64]	4.00 [102]	3.50* [89]	4.50 [114]	1.62 [41]	5.50 [140]	.41 [10]	1.16 [30]	8.43 [214]	7.54 [192]	1.09 [28]	2.29 [58]	4.98 [127]	.12 [3] x .75 [19]	.50 [13]
		4.00 † [102]														
GHS G	1-1/2" 2"	3.50* [89]	4.88 [124]	3.50* [89]	4.50 [114]	1.62 [41]	8.00 [203]	.41 [10]	1.62 [41]	12.06 [306]	10.72 [272]	1.52 [39]	3.35 [85]	5.70 [145]	.19 [5] x 1.25 [32]	.75 [19]
		4.00 † [102]														
GHS J	2" 3"	4.50* [114]	6.88 [175]	5.25* [133]	6.25 [159]	2.88 [73]	10.00 [254]	.44 [11]	2.50 [64]	15.68 [398]	14.31 [363]	2.77 [70]	4.48 [114]	8.50 [216]	.25 [6] x 2.00 [51]	1.00 [25]
		6.00 † [152]														
GHS N	2" 3"	5.12 [130]	8.00 [203]	4.50 [114]	6.25 [159]	2.88 [73]	10.00 [254]	.44 [11]	2.58 [66]	16.37 [416]	15.14 [385]	2.69 [68]	4.56 [116]	8.72 [221]	.25 [6] x 2.00 [51]	1.12 [28]
GHS R	2" 2-1/2" 3" 4"	6.50 [165]	10.50 [267]	7.00 [178]	3.75 [95]	13.75 [349]	.52 [13]	2.25 [57]	17.87 [454]	17.36 [441]	1.86 [47]	4.70 [119]	11.31 [287]	.38 [10] x 1.88 [48]	1.44 [37]	
																7.19 † [183]

* STANDARD DIMENSION

† PORTS ARE COMPATIBLE WITH 150# OR 300# ANSISTAINLESS STEEL FLANGES. ALL OTHER PORTS ARE TAPPED NPT FOR ANSI PIPE. OPTIONAL (DIN) FLANGES OR TAPPED (BSP) PORTS AVAILABLE FOR EXPORT MARKET.

‡ 180° HOUSING

GHC/GHS

FOR GHC DRIVE OPTIONS

AND DIMENSIONS

SEE SECTION 540

FOR GHS DRIVE OPTIONS

AND DIMENSIONS

SEE SECTION 545



PERFORMANCE CURVES

SPEED VS. CAPACITY/HORSEPOWER

JJ

Hydraulic
Size

SEC. 500

Page 68

January 2010

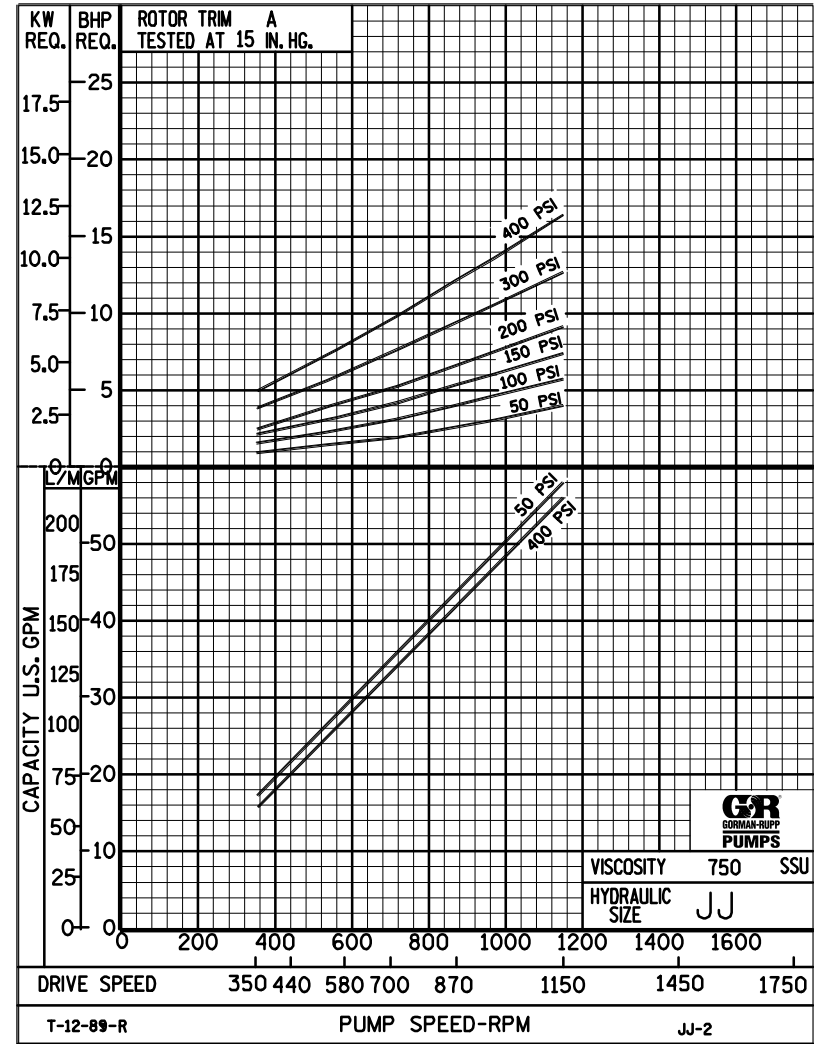
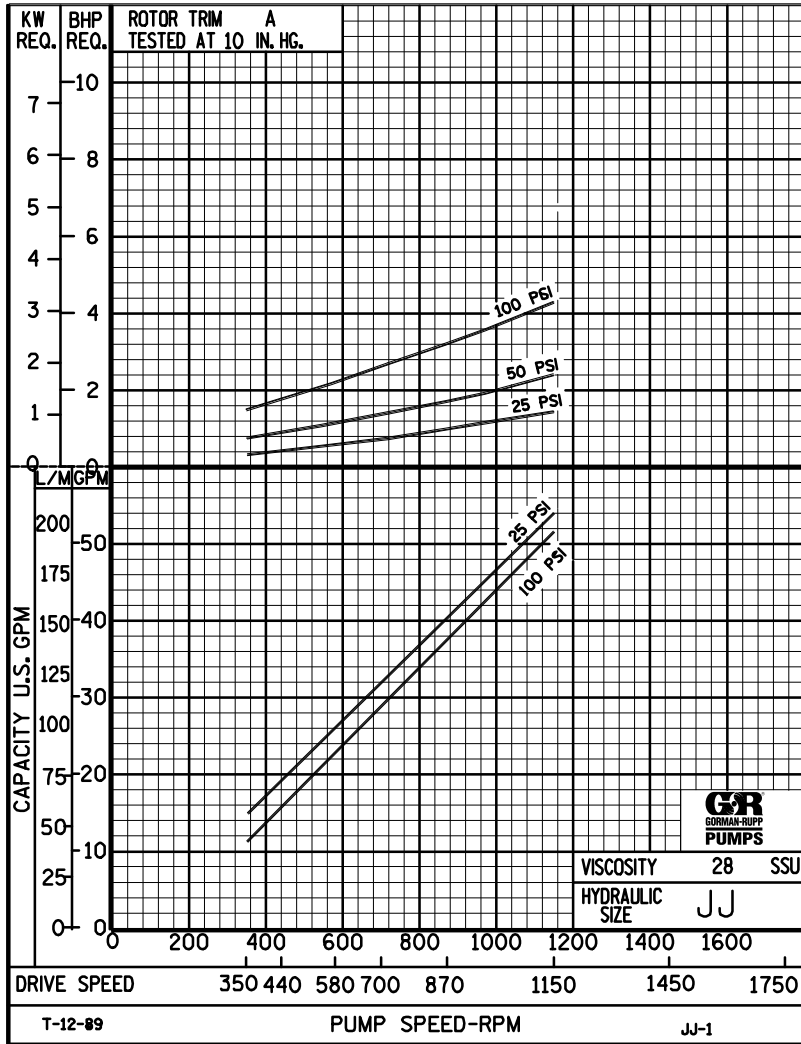

THE GORMAN-RUPP COMPANY • MANSFIELD, OHIO
GORMAN-RUPP OF CANADA LIMITED • ST. THOMAS, ONTARIO, CANADA

Printed in U.S.A.



PERFORMANCE CURVES

SPEED VS. CAPACITY/HORSEPOWER

JJ Hydraulic Size

SEC. 500

Page 69

January 2010

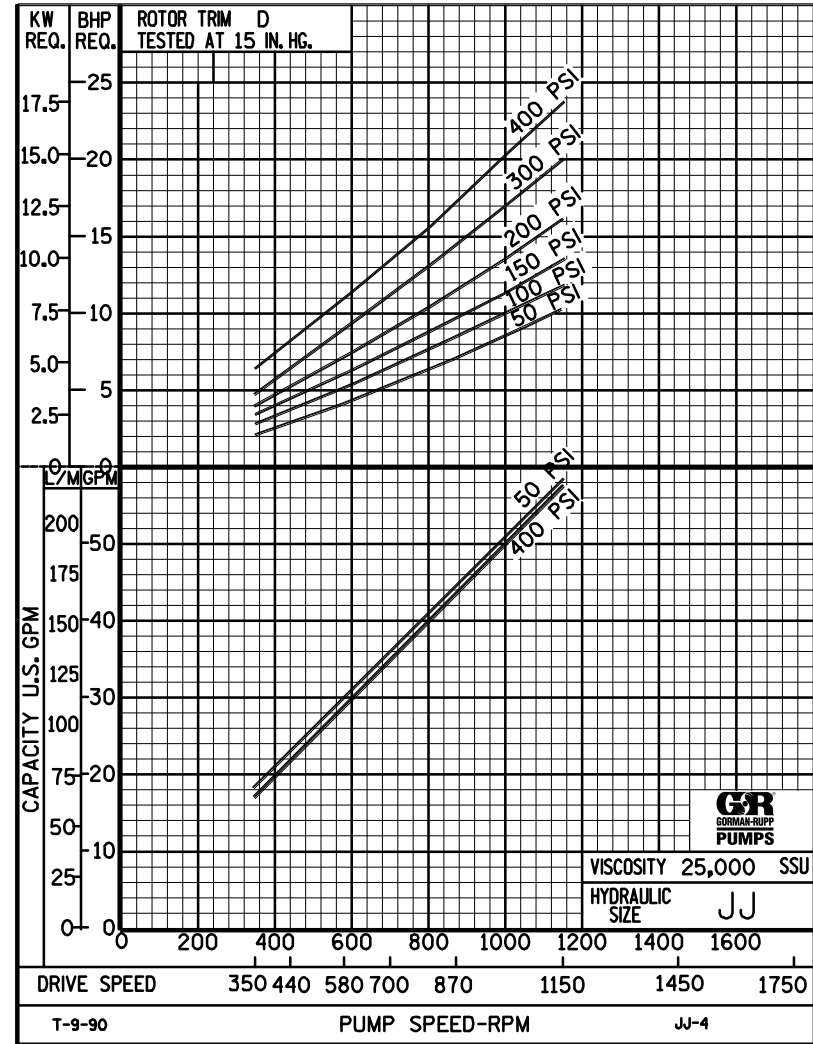
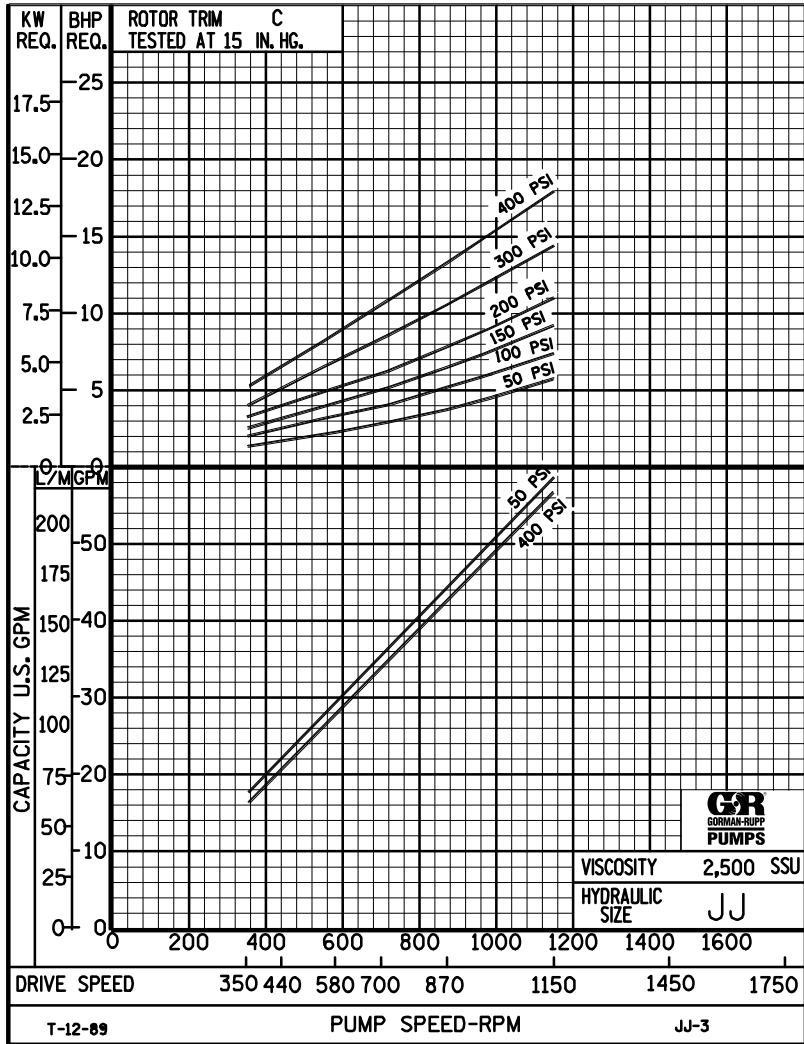

THE GORMAN-RUPP COMPANY • MANSFIELD, OHIO
 GORMAN-RUPP OF CANADA LIMITED • ST. THOMAS, ONTARIO, CANADA

Printed in U.S.A.



JJ

PUMP HYDRAULIC SIZE CHART

SEC. 500

Page 70

January 2010

56 GPM
1150 RPM

NOMINAL		ROTOR TRIM	VISCOSITY (SSU)	N.I.P.R. (PSIA)	FRICTION PIPE LOSS (PSI/FT) <small>(Based on Sch 40 Steel Pipe)</small>					FULL BYPASS RELIEF VALVE PRESSURE (PSI)					CAPACITY (GPM) / H.P. REQUIRED									
CAP. GPM	SPEED RPM				PIPE DIAMETER					CRACKING PRESS. (PSI)					DIFFERENTIAL PRESSURE (PSI)									
					1 1/2"	2"	2 1/2"	3"	4"	LOW PRES R/V			HI PRES R/V		25	50	75	100	150	200	300	400		
56 1150		STD	28	4.0	.01	.01	.01	.01	.01	62	87	114				54	52	52	51					
			32		.07	.02	.01	.01	.01						1.0	2.4	3.3	4.3						
			38	4.0	.09	.03	.01	.01	.01	62	89	116	166			55	54	53	53	51				
			50		.11	.03	.02	.01	.01						1.6	2.5	3.5	4.4	6.4					
			70	4.0	.13	.04	.02	.01	.01	63	90	118	167	219	56	55	55	54	53	52				
			100		.15	.05	.02	.01	.01						1.8	2.7	3.6	4.6	6.5	8.7				
			150	4.0	.16	.05	.02	.01	.01	64	91	120	167	219	57	56	56	55	54	54	53	52		
			200		.18	.05	.02	.01	.01						2.1	3.0	3.9	4.8	6.6	8.7	12	16		
			300	4.0	.20	.06	.03	.01	.01	65	92	122	168	220	57	57	57	56	56	55	55	54		
			500		.25	.09	.05	.02	.01						2.8	3.6	4.6	5.4	7.1	9.0	13	16		
			750	4.0	.37	.14	.07	.03	.01	66	93	124	168	220	58	58	57	57	57	57	56	56		
			1,000		.49	.18	.09	.04	.02						3.2	4.0	4.9	5.7	7.4	9.2	13	16		
			2,000	4.3	.98	.36	.18	.08	.03	70	95	124	168	222	58	58	58	58	58	57	57	56		
			3,500		1.72	.63	.31	.13	.05						4.6	5.7	6.6	7.4	9.2	11	14	18		
		5,000	4.5	2.45	.90	.44	.19	.06	72	97	126	170	224	59	58	58	58	58	58	57	57			
		7,500		3.68	1.35	.67	.28	.10						6.6	7.3	8.0	8.8	11	13	16	20			
		10,000	4.7	4.90	1.81	.89	.37	.13	74	99	128	172	226	59	58	58	58	58	58	57	57			
		15,000		7.35	2.71	1.33	.56	.19						8.8	9.0	10	11	13	15	18	2.0			
		20,000	4.9	9.80	3.61	1.77	.74	.25	78	103	128	174	226	58	58	58	58	58	58	57	57			
		25,000		12.3	4.51	2.22	.93	.31						9.7	10	11	12	14	16	20	24			
		50,000	6.9	24.5	9.02	4.43	1.86	.63	82	107	132	178	230	58	58	58	58	58	58	57	57			
		75,000		-	-	-	-	-						15	16	16	18	19	22	25	30			
		100,000	"D"																					
		150,000																						
		200,000																						
		250,000																						

(NOTE) For speeds not shown on the pump hydraulic charts, consult factory.



JJ

PUMP HYDRAULIC SIZE CHART

SEC. 500

Page 71

January 2010

**42 GPM
870 RPM**

NOMINAL		ROTOR TRIM	VISCOSITY (SSU)	N.I.P.R. (PSIA)	FRICTION PIPE LOSS (PSI/FT) (Based on Sch 40 Steel Pipe)					FULL BYPASS RELIEF VALVE PRESSURE (PSI)					CAPACITY (GPM) / H.P. REQUIRED													
CAP. GPM	SPEED RPM				PIPE DIAMETER					CRACKING PRESS. (PSI)					DIFFERENTIAL PRESSURE (PSI)													
					1½"	2"	2½"	3"	4"	LOW PRES R/V			HI PRES R/V		MEDIUM DUTY AND HEAVY DUTY				HEAVY DUTY ONLY									
42	870	STD	28	2.7	.01	.01	.01	.01	.01	60	85	117			40	39	39	38										
			32		.04	.01	.01	.01	.01						.98	1.7	2.5	3.2										
			38	2.7	.06	.02	.01	.01	.01	60	85	117	161			41	40	40	39	38								
			50		.07	.02	.01	.01	.01							1.1	1.8	2.5	3.3	4.8								
			70	2.7	.08	.03	.01	.01	.01	60	85	117	161	213			42	42	41	40.8	40	39						
			100		.09	.03	.01	.01	.01								1.1	1.9	2.6	3.3	4.9	6.4						
			150	2.7	.10	.03	.01	.01	.01	61	86	119	161	213			43	42	42	42	41	41	40	39				
			200		.10	.03	.01	.01	.01								1.3	2.0	2.7	3.4	4.9	6.5	9.1	12				
			300	2.7	.11	.04	.02	.01	.01	61	88	119	161	213			43	43	43	42	42	42	41	41				
			500		.19	.07	.03	.02	.01								1.8	2.4	3.0	3.7	5.0	6.6	9.2	12				
		750	2.7	.28	.10	.05	.02	.01	61	88	119	161	213			43	43	43	43	43	42	42	42					
		1,000		.37	.14	.07	.03	.01								2.4	2.6	3.3	4.0	5.4	6.7	9.4	13					
		2,000	3.1	.74	.27	.13	.06	.02	63	90	121	163	215			44	44	43	43	43	43	42	42					
		3,500		1.29	.47	.23	.10	.03								3.0	3.7	4.5	5.2	6.5	7.8	11	13					
		5,000	3.4	1.84	.68	.33	.14	.05	65	92	123	163	215			44	44	44	43	43	43	43	42					
		7,500		2.76	1.02	.50	.21	.07								4.6	5.3	6.0	6.6	7.8	9.1	12	15					
		10,000	3.7	3.68	1.35	.67	.28	.10	67	94	126	163	217			44	44	44	44	43	43	43	42					
		15,000		5.51	2.03	1.00	.42	.14								5.5	6.3	7.0	7.7	9.0	10	13	16					
		20,000	3.9	7.35	2.71	1.33	.56	.19	69	96	129	163	217			44	44	44	44	43	43	43	42					
		25,000		9.19	3.38	1.66	.70	.24								6.4	7.0	7.7	8.5	10	11	14	17					
50,000	5.8	18.4	6.76	3.32	1.40	.47	73	100	133	167	221			44	44	44	44	43	43	43	42							
75,000		27.6	10.2	4.99	2.09	.71								9.6	10	11	12	13	15	18	21							
100,000	7.8	36.8	13.5	6.65	2.79	.94	77	104	137	171	225			44	44	44	44	43	43	43	42							
150,000		-	-	-	-	-								12	13	14	15	16	19	21	24							
200,000																												
250,000																												

(NOTE) For speeds not shown on the pump hydraulic charts, consult factory.

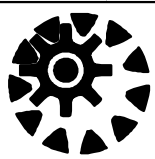

JJ

PUMP HYDRAULIC SIZE CHART

SEC. 500

Page 72

January 2010

**28 GPM
580 RPM**

NOMINAL		ROTOR TRIM	VISCOSITY (SSU)	N.I.P.R. (PSIA)	FRICTION PIPE LOSS (PSI/FT) <small>(Based on Sch 40 Steel Pipe)</small>					FULL BYPASS RELIEF VALVE PRESSURE (PSI)					CAPACITY (GPM) / H.P. REQUIRED														
CAP. GPM	SPEED RPM				PIPE DIAMETER					CRACKING PRESS. (PSI)					DIFFERENTIAL PRESSURE (PSI)														
					1½"	2"	2½"	3"	4"	LOW PRES R/V			HI PRES R/V		MEDIUM DUTY AND HEAVY DUTY				HEAVY DUTY ONLY										
28	580	STD	28	1.7	.01	.01	.01	.01	.01	54	80	111				26	25	25	24										
			32		.02	.01	.01	.01	.01							.61	1.2	1.7	2.2										
			38	1.7	.03	.01	.01	.01	.01	54	80	111	157				26	26	26	25	24								
			50		.03	.01	.01	.01	.01								.64	1.2	1.7	2.2	3.4								
			70	1.7	.04	.01	.01	.01	.01	54	81	111	157	209				27	27	26	26	25	24						
			100		.05	.02	.01	.01	.01									.69	1.2	1.8	2.2	3.4	4.2						
			150	1.7	.05	.02	.01	.01	.01	54	81	111	157	209				28	28	27	27	26	26	25	25				
			200		.05	.02	.01	.01	.01									.77	1.3	1.8	2.3	3.4	4.2	6.0	7.9				
			300	1.7	.08	.03	.01	.01	.01	55	82	111	157	209				28	28	28	27	27	27	26	26				
			500		.12	.05	.02	.01	.01									.90	1.5	1.9	2.4	3.4	4.2	6.0	7.9				
		750	1.7	19	.07	.03	.02	.01	55	82	111	157	209				29	28	28	28	28	28	28	27	27				
		1,000		.25	.09	.05	.02	.01									1.3	1.8	2.2	2.7	3.5	4.3	6.3	8.1					
		2,000	2.1	.49	.18	.09	.04	.01	57	84	113	157	209				29	29	29	28	28	28	28	28	27				
		3,500		.86	.32	.16	.07	.02									2.2	2.6	3.1	3.5	4.4	5.3	7.2	9.0					
		5,000	2.4	1.23	.45	.22	.09	.03	59	86	115	158	210				29	29	29	29	28	28	28	28	28				
		7,500		1.84	.68	.33	.14	.05									2.8	3.2	3.6	4.1	5.0	5.9	7.8	9.6					
		10,000	2.7	2.45	.90	.44	.19	.06	61	88	118	159	211				29	29	29	29	29	29	29	28	28				
		15,000		3.68	1.35	.67	.28	.10									3.3	3.7	4.2	4.7	5.6	6.6	8.5	10					
		20,000	3.0	4.90	1.81	.89	.37	.13	64	91	121	159	211				30	29	29	29	29	29	29	29	28				
		25,000		6.13	2.26	1.11	.47	.16									3.7	4.2	4.7	5.1	6.2	7.1	9.0	11					
50,000	4.6	12.3	4.51	2.22	.93	.31	67	94	124	162	214				30	29	29	29	29	29	29	29	28						
75,000		18.4	6.76	3.32	1.40	.47									5.6	6.2	6.7	7.4	8.0	9.6	11	14							
100,000	6.6	24.5	9.02	4.43	1.86	.63	71	98	128	166	218				30	29	29	29	29	29	29	29	28						
150,000		36.8	13.5	6.65	2.79	.94									7.0	7.8	8.4	9.3	9.6	12	13	16							
200,000	10.0	49.0	18.0	8.86	3.72	1.25	74	101	131	169	221				30	29	29	29	29	29	29	29	28						
250,000		-	-	-	-	-									8.4	9.4	9.9	11	11	13	15	17							

(NOTE) For speeds not shown on the pump hydraulic charts, consult factory.

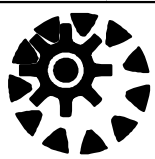

JJ

PUMP HYDRAULIC SIZE CHART

SEC. 500

Page 73
January 2010

17 GPM
350 RPM

NOMINAL		ROTOR TRIM	VISCOSITY (SSU)	N.I.P.R. (PSIA)	FRICTION PIPE LOSS (PSI/FT) <small>(Based on Sch 40 Steel Pipe)</small>					FULL BYPASS RELIEF VALVE PRESSURE (PSI)					CAPACITY (GPM) / H.P. REQUIRED													
CAP. GPM	SPEED RPM				PIPE DIAMETER					CRACKING PRESS. (PSI)					DIFFERENTIAL PRESSURE (PSI)													
					1½"	2"	2½"	3"	4"	LOW PRES R/V		HI PRES R/V			MEDIUM DUTY AND HEAVY DUTY				HEAVY DUTY ONLY									
17	350	STD	28	1.2	.01	.01	.01	.01	.01	53	79	109			15	15	15	14										
			32		.01	.01	.01	.01	.01						.33	.61	1.0	1.3										
			38	1.2	.01	.01	.01	.01	.01	53	79	109	156			16	15	15	15	14								
			50		.02	.01	.01	.01	.01							.37	.64	1.0	1.4	2.1								
			70	1.2	.02	.01	.01	.01	.01	53	79	109	156	207			16	16	16	15	15	15						
			100		.02	.01	.01	.01	.01								3.9	.69	1.1	1.4	2.1	2.8						
			150	1.2	.02	.01	.01	.01	.01	54	80	109	156	207			17	16	16	16	16	15	15	14				
			200		.03	.01	.01	.01	.01								.48	.74	1.1	1.4	2.1	2.8	3.7	4.8				
			300	1.2	.05	.02	.01	.01	.01	54	80	109	156	207			17	17	17	16	16	16	16	15				
			500		.08	.03	.02	.01	.01								.63	.82	1.1	1.5	2.1	2.8	3.7	4.8				
		750	1.2	.11	.04	.02	.01	.01	54	80	109	156	207			17	17	17	17	17	16	16	16					
		1,000		.15	.06	.03	.01	.01								.76	1.0	1.3	1.6	2.2	2.8	3.8	4.9					
		2,000	1.7	.30	.11	.06	.02	.01	55	81	110	157	208			17	17	17	17	17	17	16	16					
		3,500		.52	.19	.10	.04	.01								1.3	1.6	1.8	2.1	2.7	3.1	4.3	5.4					
		5,000	2.0	.75	.28	.14	.06	.02	56	82	111	158	209			17	17	17	17	17	17	17	17					
		7,500		1.12	.41	.20	.09	.03								1.6	1.9	2.2	2.4	3.0	3.5	4.6	5.7					
		10,000	2.3	1.49	.55	.27	.11	.04	57	84	112	159	210			17	17	17	17	17	17	17	17					
		15,000		2.23	.82	.40	.17	.06								1.8	2.2	2.5	2.8	3.4	3.9	5.0	6.2					
		20,000	2.5	2.98	1.10	.54	.23	.08	59	86	113	159	210			18	17	17	17	17	17	17	17					
		25,000		3.72	1.37	.67	.28	.10								2.0	2.5	2.8	3.0	3.7	4.3	5.4	6.5					
50,000	3.9	7.44	2.74	1.35	.57	.19	61	88	115	161	212			18	17	17	17	17	17	17	17							
75,000		11.2	4.11	2.02	.85	.29								3.0	3.7	4.0	4.4	4.6	5.9	6.7	8.1							
100,000	5.6	14.9	5.48	2.69	1.13	.38	64	91	118	164	215			18	17	17	17	17	17	17	17							
150,000		22.3	8.21	4.04	1.69	.57								3.7	4.7	5.0	5.4	5.7	7.0	7.8	9.3							
200,000	8.4	29.8	11.0	5.38	2.26	.76	67	94	121	167	218			18	17	17	17	17	17	17	17							
250,000		37.2	13.7	6.73	2.82	.95								4.5	5.6	5.9	6.4	6.5	8.1	8.7	10							

(NOTE) For speeds not shown on the pump hydraulic charts, consult factory.