

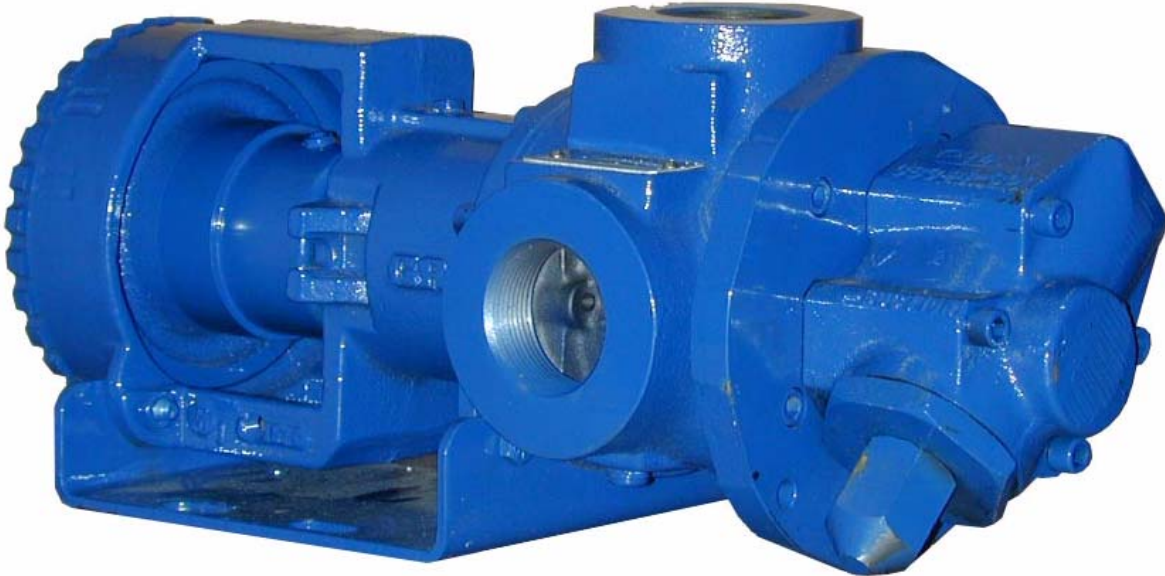

**HEAVY DUTY STANDARD;
 D, G, J, N & R HYD SIZE
 ROTARY GEAR PUMP**



The GHS iron series is designed for applications in the operating ranges noted below. These units are available with head and backhead jackets for temperature control, carbon graphite bushings for low viscosity liquids, silicon carbide bushings for wear resistance, and numerous shaft seal options described on the following pages

This heavy duty series provides superior rotor shaft support and an integral, maintenance-free radial/thrust bearing for reduced deflection and wear.

FEATURES

- 400 PSI CAPABILITY
- BALL BEARING THRUST CONTROL
- ROTOR END CLEARANCE EXTERNALLY ADJUSTABLE
- OPTIMIZED LOAD SUPPORT AND HIGH STRENGTH SHAFT
- HIGH STRENGTH, COMPUTER PROFILED GEARING FOR QUIET OPERATION
- FLEXIBLE SEAL DESIGN ALLOWS FOR A VARIETY OF INDUSTRY STANDARD SEALS OR PACKING
- INTERNAL SEAL VENT
- DEEP END FEED DESIGN

OPERATING RANGE

- CAPACITY (GPM) : (3 TO 295)
 [LPM] : [11 TO 1116]
- PRESSURE (PSI) : [0 TO 300]
 [BAR] : [0 TO 20.7]
- VISCOSITY (SSU) : (28 TO 2,000,000)
 [cSt] : [1 TO 440,000]
- TEMPERATURE (F) : (-60° TO 675°)
 [C] : [-51° TO 358°]

APPLICATIONS

- USE WITH ANY CLEAN LIQUID
 COMPATIBLE WITH CAST IRON
- ★ BOOSTER SERVICE
 - ★ CIRCULATING
 - ★ FILTERING
 - ★ LUBRICATING
 - ★ TRANSFERRING
 - ★ LOW PRESSURE FLUID POWER
 - ★ METERING

EXTER- IOR	ROTOR & IDLER	HOUSING PORTS	BUSHINGS	IDLER PIN	SHAFT	SHAFT SEALING		ROTATION	INTERNAL RELIEF VALVE	
						MECH. SEAL ●	PACKING ■		MATERIAL	SETTING
CAST IRON	HIGH STRENGTH IRON	90° TAPPED 125# FLG	BRONZE	HARDENED STEEL	STEEL	VITON	CARBON FIBER	C.W.	DUCTILE IRON	75 PSI [5 BAR]

Standard Models

G H S 1 DC 3 - B
 GEAR DUTY DESIGN PORT SIZE HYDRAULIC SEAL STYLE
 SIZE SIZE

MODEL NUMBER	NOM. CAPACITY - SPEED				MAXIMUM				SHIPPING DATA	
	MAXIMUM		ALTERNATIVE		DIFFERENTIAL PRESSURE-PSI [BAR]			TEMP.	Weight	Volume
	GPM [LPM]	RPM 60 Hz [50 HZ]	GPM [LPM]	RPM ^② 60 Hz [50 HZ]	BELOW 38 SSU [4 cSt]	38 TO 100 SSU [21 cSt]	100 TO 250,000 SSU [55,000 cSt]	°F [°C]		
GHS 1DC 3-B ● ① GHS 1DC 4-B ■ ①	9 [28]		6 [19]						30 [13,6]	2.9
GHS 1DE 3-B ● ① GHS 1DE 4-B ■ ①	11 [35]		7 [22]						30 [13,6]	2.9
GHS 1-1/2 GC 3-B ● GHS 1-1/2 GC 4-B ■	16 [50]		10 [32]				300 [20.7]	● 400 [204]	54 [24,5]	2.9
GHS 2 GC 3-B ● GHS 2 GC 4-B ■									54 [24,5]	2.9
GHS 1-1/2 GF 3-B ● GHS 1-1/2 GF 4-B ■	23 [73]	1750 [1460]	15 [47]	1150 [960]	100 [7]	150 [10]			54 [24,5]	2.9
GHS 2 GF 3-B ● GHS 2 GF 4-B ■									54 [24,5]	2.9
GHS 1-1/2 GH 3-B ● GHS 1-1/2 GH 4-B ■	31 [98]		20 [63]						54 [24,5]	2.9
GHS 2 GH 3-B ● GHS 2 GH 4-B ■									54 [24,5]	2.9
GHS 1-1/2 GJ 3-B ● ③ GHS 1-1/2 GJ 4-B ■ ③	38 [120]		25 [79]				200 [14]	■ 500 [260]	54 [24,5]	2.9
GHS 2 GJ 3-B ● ③ GHS 2 GJ 4-B ■ ③									54 [24,5]	2.9
GHS 2 JG 3-B ● GHS 2 JG 4-B ■	40 [126]	1150 [960]	30 [95]	870 [725]			300 [20.7]		125 [57]	5.3
GHS 2-1/2 JG 3-B ● GHS 2-1/2 JG 4-B ■									125 [57]	5.3
GHS 3 JG 3-B ● GHS 3 JG 4-B ■									125 [57]	5.3

STANDARD MODELS CONT.

NOTE: RECOMMENDED PORT SIZES ARE SHOWN IN **BOLDFACE**. EXAMPLE: **GHS 2JG 3-B**

- MECHANICAL SEAL
- LIPSEAL/PACKING

- ① 3450 [2875] RPM PERMISSIBLE TO 1,000 SSU [220 Cts.] AND 100 PSI [7 BAR]
- ② MAXIMUM SPEED FOR AMMONIA MODELS.
- ③ PUMP LIMITED TO 200 PSI MAXIMUM PRESSURE.

THE GORMAN-RUPP COMPANY • MANSFIELD, OHIO
GORMAN-RUPP OF CANADA LIMITED • ST. THOMAS, ONTARIO, CANADA

Standard Models Cont'd

MODEL NUMBER	NOM. CAPACITY - SPEED				MAXIMUM				SHIPPING DATA	
	MAXIMUM		ALTERNATIVE		DIFFERENTIAL PRESSURE-PSI [BAR]			TEMP.	Weight	Volume
	GPM [LPM]	RPM 60 Hz [50 HZ]	GPM [LPM]	RPM ^① 60 Hz [50 HZ]	BELOW 38 SSU [4 cSt]	38 TO 100 SSU [21 cSt]	100 TO 250,000 SSU [55,000 cSt]	°F [°C]		
GHS 2 JJ 3-B ● GHS 2 JJ 4-B ■	56 [177]	1150 [960]	42 [133]	870 [725]	100 [7]	150 [10]	300 ^③ [20.7]	● 400 [204]	125 [57]	5.3
GHS 2-1/2 JJ 3-B ● GHS 2-1/2 JJ 4-B ■									125 [57]	5.3
GHS 3 JJ 3-B ● GHS 3 JJ 4-B ■									125 [57]	5.3
GHS 2 JL 3-B ● GHS 2 JL 4-B ■	77 [243]	1150 [960]	58 [183]	870 [725]	100 [7]	150 [10]	300 ^③ [20.7]	● 400 [204]	125 [57]	5.3
GHS 2-1/2 JL 3-B ● GHS 2-1/2 JL 4-B ■									125 [57]	5.3
GHS 3 JL 3-B ● GHS 3 JL 4-B ■									125 [57]	5.3
GHS 2 JP 3-B ● GHS 2 JP 4-B ■ ②	107 [338]	1150 [960]	81 [256]	870 [725]	100 [7]	150 [10]	200 [14]	● 400 [204]	125 [57]	5.3
GHS 2-1/2 JP 3-B ● GHS 2-1/2 JP 4-B ■ ②									125 [57]	5.3
GHS 3 JP 3-B ● GHS 3 JP 4-B ■ ②									125 [57]	5.3
GHS 1-1/2 NK 3-B ● GHS 1-1/2 NK 4-B ■	99 [375]	960 [960]	60 [189]	580 [480]	100 [7]	150 [10]	300 ^③ [20.7]	■ 500 [260]	167 [75,7]	5.3
GHS 2 NK 3-B ● GHS 2 NK 4-B ■									167 [75,7]	5.3
GHS 2-1/2 NK 3-B ● GHS 2-1/2 NK 4-B ■									167 [75,7]	5.3
GHS 3 NK 3-B ● GHS 3 NK 4-B ■	132 [500]	960 [960]	80 [252]	580 [480]	100 [7]	150 [10]	300 ^③ [20.7]	■ 500 [260]	167 [75,7]	5.3
GHS 2 NM 3-B ● GHS 2 NM 4-B ■									167 [75,7]	5.3
GHS 2-1/2 NM 3-B ● GHS 2-1/2 NM 4-B ■									167 [75,7]	5.3
GHS 3 NM 3-B ● GHS 3 NM 4-B ■	165 [624]	960 [960]	99 [312]	580 [480]	100 [7]	150 [10]	200 [14]	■ 500 [260]	167 [75,7]	5.3
GHS 2 NP 3-B ● GHS 2 NP 4-B ■ ②									167 [75,7]	5.3
GHS 2-1/2 NP 3-B ● GHS 2-1/2 NP 4-B ■ ②									167 [75,7]	5.3
GHS 3 NP 3-B ● GHS 3 NP 4-B ■ ②	165 [624]	960 [960]	99 [312]	580 [480]	100 [7]	150 [10]	200 [14]	■ 500 [260]	167 [75,7]	5.3
GHS 2 NP 3-B ● GHS 2 NP 4-B ■ ②									167 [75,7]	5.3
GHS 2-1/2 NP 3-B ● GHS 2-1/2 NP 4-B ■ ②									167 [75,7]	5.3

STANDARD MODELS CONT.

NOTE: RECOMMENDED PORT SIZES ARE SHOWN IN **BOLDFACE**. EXAMPLE: GHS 2JG 3-B

- ① MAXIMUM SPEED FOR AMMONIA MODELS.
- ② PUMP LIMITED TO 200 PSI MAXIMUM PRESSURE.
- ③ FOR 200-300 PSI OPERATION, HOUSING BUSHING IS RECOMMENDED. CONSULT BUSHING LIMITATION TABLE OR CONSULT FACTORY.

- MECHANICAL SEAL
- LIPSEAL/PACKING

THE GORMAN-RUPP COMPANY • MANSFIELD, OHIO
GORMAN-RUPP OF CANADA LIMITED • ST. THOMAS, ONTARIO, CANADA

MODEL NUMBER	NOM. CAPACITY - SPEED				MAXIMUM				SHIPPING DATA	
	MAXIMUM		ALTERNATIVE		DIFFERENTIAL PRESSURE - PSI [BAR]			TEMP.	Weight	Volume
	GPM [LPM]	RPM 60 Hz [50 HZ]	GPM [LPM]	RPM ^① 60 Hz [50 HZ]	BELOW 38 SSU [4 cSt]	38 TO 100 SSU [21 cSt]	100 TO 250,000 SSU [55,000 cSt]	°F [°C]		
GHS 2 RM 3-B ● GHS 2 RM 4-B ■	172 [542]	720 [600]	115 [362]	480 [400]	100 [7]	150 [10]	300 [20.7]	● 400 [204]	301	10.7
GHS 2-1/2 RM 3-B ● † GHS 2-1/2 RM 4-B ■ †									[136]	10.7
GHS 3 RM 3-B ● † GHS 3 RM 4-B ■ †									[136]	10.7
GHS 4 RM 3-B ● † GHS 4 RM 4-B ■ †									[136]	10.7
GHS 2-1/2 RP 3-B ● † GHS 2-1/2 RP 4-B ■ †	215 [678]	720 [600]	143 [451]	480 [400]	100 [7]	150 [10]	300 [20.7]	● 400 [204]	301	10.7
GHS 3 RP 3-B ● † GHS 3 RP 4-B ■ †									[136]	10.7
GHS 4 RP 3-B ● † GHS 4 RP 4-B ■ †									[136]	10.7
GHS 2-1/2 RR 3-B ● † GHS 2-1/2 RR 4-B ■ †									[136]	10.7
GHS 3 RR 3-B ● † GHS 3 RR 4-B ■ †	255 [804]	720 [600]	170 [536]	480 [400]	100 [7]	150 [10]	300 [20.7]	● 400 [204]	301	10.7
GHS 4 RR 3-B ● † GHS 4 RR 4-B ■ †									[136]	10.7
GHS 3 RS 3-B ● † GHS 3 RS 4-B ■ †									[136]	10.7
GHS 4 RS 3-B ● † GHS 4 RS 4-B ■ †									[136]	10.7
GHS 3 RS 3-B ● † GHS 3 RS 4-B ■ †	295 [930]	720 [600]	196 [618]	480 [400]	100 [7]	150 [10]	300 [20.7]	● 400 [204]	301	10.7
GHS 4 RS 3-B ● † GHS 4 RS 4-B ■ †									[136]	10.7

- ① MAXIMUM SPEED FOR AMMONIA MODELS.
- ② PUMP LIMITED TO 200 PSI MAXIMUM PRESSURE

- MECHANICAL SEAL
- LIPSEAL/PACKING
- † PORTS ARE COMPATIBLE WITH 125# ANSI CAST IRON FLANGES. ALL OTHER PORTS ARE TAPPED NPT FOR ANSI PIPE. OPTIONAL [DIN] FLANGES OR TAPPED [BSP] PORTS AVAILABLE FOR EXPORT MARKET.

APPLICATION RECOMMENDATIONS:		
APPLICATION	OPTIONS REQUIRED (Select One From Each Row)	OPERATING LIMITATIONS
HIGH TEMPERATURE	25U, 25V, OR 25W 35J – 35M (AS REQ'D) 40M, 40W 61H, OR 65Q 70F OR 70K	TEMPERATURE: 675°F MAX. PRESSURE: 200 PSI MAX.
AMMONIA	25G OR 25H 40N 60K 70E 90A	PRESSURE: 200 PSI MAX. 2/3 RATED SPEED 4 FEET NPSHr
LP GAS	25G OR 25H 40F OR 40N 70D OR 70E	PRESSURE: 200 PSI MAX. 3 FEET NPSHr
ASPHALT	25U, 25V OR 25W 35J–35M (AS REQ'D) 40G, 40M, 40W 41R, 41W 65S 70B, 70K 71K	TEMPERATURE: 500°F MAX.
JACKETED	40G, 40J, 40K, 40W, 41U, 41W 70B, 70G, 70K 71K, 71M	LIMIT JACKET PRESSURE TO 150 PSIG

NOTE: PROPER PUMP APPLICATION REQUIRES CONSIDERATION OF ADDITIONAL FACTORS. PLEASE REVIEW APPLICATION GUIDE IN SECTION 500 OR CONSULT THE FACTORY.

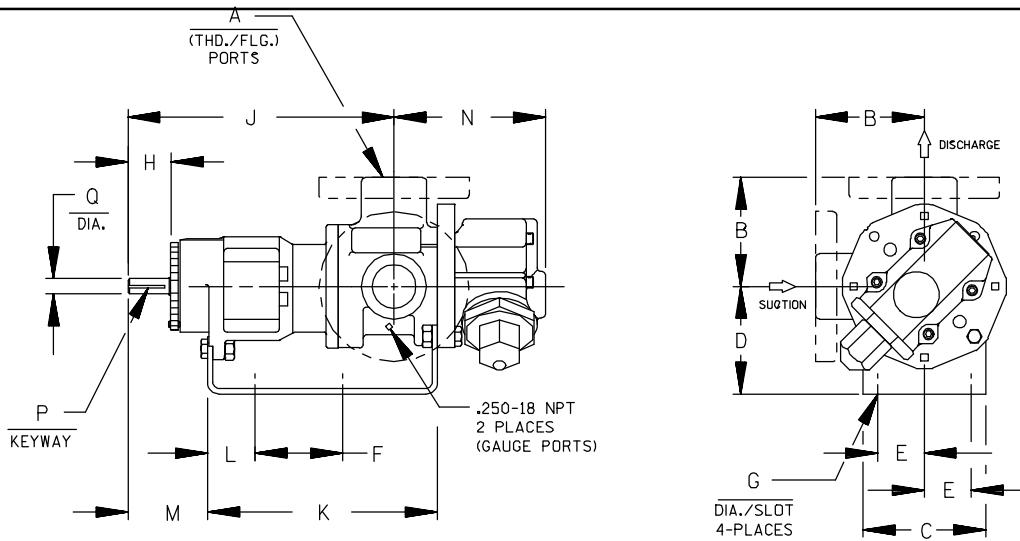

CAD FILE NO.: 16669

MODEL NUMBERS	PUMP DIMENSIONS - INCHES [MILLIMETERS]															
	A	B	C	D	E	F	G	H	J	K	L	M	N	P	Q	
GHS D	1"	2.50* [64]	4.00 [102]	3.50* [89]	4.50 [114]	1.62 [41]	5.50 [140]	.41 [10]	1.16 [30]	8.43 [214]	7.54 [192]	1.09 [28]	2.29 [58]	4.98 [127]	.12 [3] x .75 [19]	.50 [13]
GHS G GHA G	1-1/2"	3.50* [89]	4.88 [124]	3.50* [89]	4.50 [114]	1.62 [41]	8.00 [203]	.41 [10]	1.62 [41]	12.06 [306]	10.72 [272]	1.52 [39]	3.35 [85]	5.70 [145]	.19 [5] x 1.25 [32]	.75 [19]
	2"	3.75 [95]		5.25 [133]	6.25 [159]											
GHS J GHA J	2"	4.50* [114]	6.88 [175]	5.25* [133]	6.25 [159]	2.88 [73]	10.00 [254]	.44 [11]	2.50 [64]	15.68 [398]	14.31 [363]	2.77 [70]	4.48 [114]	8.50 [216]	.25 [6] x 2.00 [51]	1.00 [25]
	2-1/2"	5.00 [127]		7.00 [178]												
	3"	6.00 [152]		8.00 [203]												
GHS N GHA N	1-1/2"	5.12* [130]	8.00 [203]	4.50 [114]	6.25 [159]	2.88 [73]	10.00 [254]	.44 [11]	2.58 [66]	17.45 [443]	15.14 [385]	2.69 [68]	4.56 [116]	7.59 [193]	.25 [6] x 2.00 [51]	1.12 [32]
	2"	5.25 [133]		7.00 [178]												
	2-1/2"	7.19 [183]		8.00 [203]												
	3"	7.19 [183]		8.00 [203]												
GHS R GHA R	2"	6.50* [165]	10.50 [267]	7.00 [178]	3.75 [95]	13.75 [349]	.52 [13]	2.25 [57]	17.87 [454]	17.36 [441]	1.86 [47]	4.70 [119]	11.31 [287]	.38 [10] x 1.88 [48]	1.44 [37]	
	2-1/2"	7.19 [183]														
	3"	7.19 [183]														
	4"	7.19 [183]														

† PORTS ARE COMPATIBLE WITH 125* OR 250* ANSICAST IRON FLANGES. ALL OTHER PORTS ARE TAPPED NPT FOR ANSIPIPE. OPTIONAL (DIN) FLANGES OR TAPPED (BSP) PORTS AVAILABLE FOR EXPORT MARKET.
* STANDARD DIMENSION † 180° HOUSING

THE GORMAN-RUPP COMPANY • MANSFIELD, OHIO
GORMAN-RUPP OF CANADA LIMITED • ST. THOMAS, ONTARIO, CANADA



GHS & GHA

DIRECT FLEX DRIVE OPTION DIMENSIONS



PUMP MODEL	PUMP DIMENSIONS - INCHES[MILLIMETERS]													
	A	MOTOR FRAME	B	C	D	E	F	G	H	J	K	L	M	N
GHS D	1"	56/56H	2.50* [64]	2.00 [51]	3.50* [89]	4.44 [113]	8.88 [226]	10.14 [258]		20.29 [515]	19.25 [489]	25.25 [641]	3.00 [76]	4.97 [126]
		143T/145T	2.75 † [70]	4.00 [102]	4.50 [114]	7.75 [197]	15.50 [394]	17.50 [445]	.56 [14]	26.66 [677]	23.50 [597]	33.50 [851]	5.00 [127]	
		182T/184T	3.19 † [81]											
		213T/215T	4.00 † [102]											
GHS G GHA G	1- 1/2"	56/56H	3.50* [89]	2.00 [51]	3.50* [89]	4.44 [113]	8.88 [226]	10.14 [258]		19.93 [506]	19.25 [489]	25.25 [641]	3.00 [76]	5.70 [145]
		143T/145T	3.75 † [95]											
	182T/184T	4.00 [102]		4.50 [114]	7.75 [197]	15.50 [394]	17.50 [445]	.56 [14]	26.30 [668]	23.50 [597]	33.50 [851]	5.00 [127]		
	213T/215T												6.25 [159]	
254T/256T	4.00 † [102]													
GHS J GHA J	2"	182T/184T	4.50* [114]	4.00 [102]	4.50 [114]	9.50 [241]	19.00 [483]	21.00 [533]		36.28 [922]	35.50 [902]	45.50 [1156]	5.00 [127]	8.49 [216]
		213T/215T	5.00 † [127]											
	2- 1/2"	254T/256T	6.00 † [152]											
		284T/286T	6.00 † [152]											
3"	324T/326T	6.31 † [160]												
	324T/326T	8.00 † [203]												
GHS N GHA N	1- 1/2"	182T/184T	5.12* [130]	4.00 [102]	4.50 [114]	9.50 [241]	19.00 [483]	21.00 [533]		36.87 [936]	35.50 [902]	45.50 [1156]	5.00 [127]	8.70 [221]
		213T/215T												
	2"	254T/256T	5.25 † [133]											
		284T/286T	7.00 † [178]											
2- 1/2"	284T/286T	7.19 † [183]												
	324T/326T		8.00 † [203]											

* STANDARD DIMENSION

† PORTS ARE COMPATIBLE WITH 125# OR 250# ANSICAST IRON FLANGES. ALL OTHER PORTS ARE TAPPED NPT FOR ANSIPIPE. OPTIONAL (DIN) FLANGES OR TAPPED (BSP) PORTS AVAILABLE FOR EXPORT MARKET.

† 180° HOUSING

GHS & GHA

DIRECT FLEX DRIVE OPTIONS

(Drive Assembly Number Includes Base, Coupling & Guard, But **NOT** the Motor)



PUMP MODEL NUMBER	RPM	FRAME	MTG. FT. OPTION REQ.	DRIVE ASSY NO.
GHS GHA D	3450 1750 1150 850	56/56H	STD	90451-086
		143T/145T	STD	90451-018
		182T/184T	80F	90451-058
		213T/215T	80J	90451-062
GHS GHA G	1750 1150 850	56/56H	STD	90451-160
		143T/145T	STD	90451-162
		182T/184T	80F	90451-168
		213T/215T	80J	90451-176
		254T	80P	90451-180
GHS GHA J	1150 850	182T/184T	80F	90451-260
		213T/215T	STD	90451-264
		254T/256T	80P	90451-272
		284T/286T	80S	90451-280
		324T/326T	80V	90451-288
GHS GHA N	850	254T/256T	80P	90451-390
		284T/286T	80S	90451-398
		324T/326T	80V	90451-406

NOTE: CONSULT FACTORY FOR;
 1. HORSEPOWERS & FRAMES NOT SHOWN
 2. DRIP PAN BASES



GHS & GHA

GRR REDUCER C-FLANGE FLEX DRIVE OPTION DIMENSIONS (56C - 215TC Frame Size Range)



CAD FILE NO.: 16551

PUMP MODEL	PUMP DIMENSIONS - INCHES[MILLIMETERS]													
	A	MOTOR FRAME	B	C	D	E	F	G	H	J	K	L	M	N
GHS D	1"	56C	2.50* [64]	2.00 [51]	3.50* [89]	4.41 [112]	13.00 [330]	15.00 [381]	.56 [14]	26.58 [675]	25.50 [648]	31.50 [800]	3.00 [76]	4.98 [126]
		143TC/145TC	2.75 † [70]											
		184C	3.19 † [81]											
		182TC/184TC	4.00 † [82]											
GHS G GHA G	1- 1/2"	56C	3.50* [89]	2.00 [51]	3.50* [89]	4.41 [112]	13.00 [330]	15.00 [381]	.56 [14]	26.22 [667]	25.50 [648]	31.50 [800]	3.00 [76]	5.72 [145]
		143TC/145TC	3.75 † [95]											
	2"	182TC/184TC	4.00 † [102]											
		213TC/215TC	5.25 [133]											
GHS J GHA J	2"	182TC/184TC	4.50* [114]	2.00 [51]	4.50 [114]	5.50 [140]	14.62 [372]	16.62 [422]	.56 [14]	35.96 [913]	37.25 [946]	43.25 [1098]	3.00 [76]	8.50 [216]
	2- 1/2"	213TC/215TC	5.00 † [127]											
			6.00 † [152]											
3"	6.31 † [160]													
GHS N GHA N	1- 1/2"	182TC/184TC	5.12* [130]	2.00 [51]	4.50 [114]	5.50 [140]	14.62 [372]	16.62 [422]	.56 [14]	36.88 [931]	37.25 [946]	43.25 [1098]	3.00 [76]	8.71 [221]
	2"	213TC/215TC	5.25 † [133]											
			7.19 † [183]											
2- 1/2"	7.19 † [183]													

* STANDARD DIMENSION

† PORTS ARE COMPATIBLE WITH 125* OR 250* ANSI/AST IRON FLANGES. ALL OTHER PORTS ARE TAPPED NPT FOR ANSI PIPE. OPTIONAL (DIN) FLANGES OR TAPPED (BSP) PORTS AVAILABLE FOR EXPORT MARKET.

† 180° HOUSING



GHS & GHA

GRR REDUCER C-FLANGE FLEX DRIVE OPTION DIMENSIONS (213TC - 326TC Frame Size Range)



CAD FILE NO. : 16640

PUMP MODEL	MOUNTING DIMENSIONS																
	A	MOTOR FRAME	B	C	D	E	F	G	H	J	K	L	M	N	P	R	
GHS J	2"	213TC/215TC	4.50 * [114]														
		254TC/256TC	5.00 † [127]								7.59 * [193]		41.58 [1056]	23.00 [584]	56.00 [1422]	18.14 [461]	10.58 [269]
GHA J	2 1/2"	254TC/256TC	6.00 † [152]	6.00 [152]	6.25 [159]	10.12 [257]	20.25 [514]	22.50 [572]	.69 [18]		5.00 [127]						
		284TC/286TC	6.31 † [160]								8.70 [221]		47.00 [1194]	25.75 [654]	61.50 [1562]	20.91 [531]	10.66 [271]
GHS N	2"	213TC/215TC	5.12 * [130]														18.14 [461]
		254TC/256TC	5.25 † [130]	6.00 [152]	6.25 [159]	10.12 [257]	20.25 [514]	22.50 [572]	.69 [18]		5.00 [127]						15.75 [400]
GHA N	2 1/2"	254TC/256TC	7.19 † [183]							8.70 [221]		47.69 [1211]	25.75 [654]	61.50 [1562]			20.91 [531]
		284TC/286TC															
GHS R	2 1/2"	182TC/184TC 213TC/215TC	6.50 [165]										38.95 [989]	22.62 [575]	55.25 [11403]	19.86 [504]	12.66 [322]
		213TC/215TC 254TC/256TC	7.19 † [183]	8.00 [203]	7.00 [178]	10.38 [264]	20.75 [527]	23.00 [584]	.69 [18]	11.31 [287]	5.00 [127]		44.25 [1124]	25.28 [642]	60.56 [1538]	20.26 [515]	12.39 [315]
		254TC/256TC 284TC/286TC											49.20 [1250]	27.75 [705]	65.50 [1664]	23.58 [585]	12.50 [318]
GHA R	3"	284TC/286TC	6.50 [165]										53.01 [1346]	29.75 [756]	68.50 [1756]	25.94 [659]	12.50 [318]
		324TC/326TC	7.19 † [183]	7.00 [178]	7.00 [178]	10.38 [264]	22.75 [578]	25.00 [635]	.69 [18]	11.31 [287]	5.00 [127]		57.95 [1472]	32.12 [816]	74.25 [1886]	28.44 [721]	13.50 [343]
		284TC/286TC													74.25 [1886]	26.44 [667]	13.50 [343]

STANDARD DIMENSION
 † PORTS ARE COMPATIBLE WITH 125* OR 250* ANSICAST IRON FLANGES. ALL OTHER
 PORTS ARE TAPPED NPT FOR ANSI PIPE. OPTIONAL (DIN) FLANGES OR TAPPED (BSP)
 PORTS AVAILABLE FOR EXPORT MARKET.
 † 180° HOUSING

GRR REDUCER C-FLANGE FLEX DRIVE OPTIONS

(Drive Assy Number Includes Base, Coupling, Guard & Gear Reducer, But **NOT** the Motor)



PUMP MODEL NUMBER	PUMP RPM @1750	PUMP RPM @1150	REDUCER ①		FRAME	MTG. FT. OPTION	DRIVE ASSY NO.
			RATIO	MAX.HP			
GHS GHA D	875	575	2.00:1	5.65	56C	STD	90453-510
				11.70	143TC/145TC	STD	90453-516
				11.70	182C/184C	80F	90453-519
				13.01	182TC/184TC	80F	90453-526
	580	383	3.00:1	3.76	56C	STD	90453-530
				8.10	143TC/145TC	STD	90453-533
				8.10	182C/184C	80F	90453-539
				10.62	182TC/184TC	80F	90453-546
	440	288	4.00:1	2.82	56C	STD	90453-550
				5.90	143TC/145TC	STD	90453-553
				5.90	182C/184C	80F	90453-562
				7.24	182TC/184TC	80F	90453-566
	350	230	5.00:1	2.26	56C	STD	90453-570
				5.20	143TC/145TC	STD	90453-573
				5.20	182C/184C	80F	90453-582
				5.98	182TC/184TC	80F	90453-586
GHS GHA G	875	575	2.00:1	5.65	56C	STD	90453-610
				11.70	143TC/145TC	STD	90453-613
				11.70	182C/184C	80F	90453-622
				13.01	182TC/184TC	80F	90453-626
	580	383	3.00:1	3.76	56C	STD	90453-630
				8.10	143TC/145TC	STD	90453-633
				8.10	182C/184C	80F	90453-642
				10.62	182TC/184TC	80F	90453-646
	440	288	4.00:1	10.62	213TC/215TC	80J	90453-648
				2.82	56C	STD	90453-660
				5.90	143TC/145TC	STD	90453-663
				5.90	182C/184C	80F	90453-672
	350	230	5.00:1	7.24	182TC/184TC	80F	90453-676
				7.24	213TC	80J	90453-677
				2.26	56C	STD	90453-690
				5.20	143TC/145TC	STD	90453-693
			5.20	182C/184C	80F	90453-702	
			5.98	182TC/184TC	80F	90453-706	
			5.98	213TC	80J	90453-708	

(CONT'D)

① Listed reducer horsepower rated for Standard Service (8-10 hrs/day). For Light Service (3-5 hrs/day) multiply maximum rated horsepower by 1.1. For Heavy Service (16-24 hrs/day) multiply maximum rated horsepower by 0.9.

② Based on 1750 RPM input.

NOTE: CONSULT FACTORY FOR;

1. HORSEPOWERS & FRAMES NOT SHOWN
2. DRIP PAN BASES



GHS & GHA

SEC. 545

PAGE 21

January 2010

GRR REDUCER C-FLANGE FLEX DRIVE OPTIONS

(Drive Assy Number Includes Base, Coupling, Guard & Gear Reducer, But **NOT** the Motor)

PUMP MODEL NUMBER	PUMP RPM @1750	PUMP RPM @1150	REDUCER ①		FRAME	MTG. FT. OPTION	DRIVE ASSY NO.
			RATIO	MAX.HP			
GHS GHA J	875	575	2.00:1	13.01	182TC/184TC	80F	90453-722
				13.01	213TC/215TC	STD	90453-726
				36.29	254TC/256TC	80P	90453-728
				36.29	284TC/286TC	80P	90453-732
	580	383	3.00:1	10.62	182TC/184TC	80F	90453-737
				10.62	213TC/215TC	80J	90453-741
	555	365	3.15:1	25.76	254TC/256TC	80P	90453-743
				42.96	284TC/286TC	80P	90453-746
	440	288	4.00:1	7.24	182TC/184TC	80F	90453-752
				7.24	213TC	80J	90453-754
	350	230	5.00:1	5.98	182TC/184TC	80F	90453-769
				5.98	213TC	STD	90453-769
				16.01	215TC	80P	90453-774
				30.49	254TC/256TC	80J	90453-778
	278	183	6.30:1	5.94	182TC/184TC		90453-850
				13.36	213TC/215TC	80F	90453-852
				23.43	254TC/256TC		90453-853
	219	144	8.00:1	9.47	182TC/184TC	80F	90453-856
18.48				213TC/215TC	80F	90453-857	
18.48				254TC/256TC		90453-858	
GHS GHA N	875	575	2.00:1	13.01	184TC	80F	90453-795
				13.01	213TC/215TC	STD	90453-799
				36.29	254TC/256TC	80P	90453-801
				36.29	284TC/286TC	80P	90453-805
	580	383	3.00:1	8.10	143T/145T	STD	90453-806
				10.62	182TC/184TC	80F	90453-810
				10.62	213TC/215TC	STD	90453-812
	555	365	3.15:1	25.76	254TC/256TC	80P	90453-817
				42.96	284TC/286TC	80P	90453-821
	440	288	4.00:1	7.24	184TC	80F	90453-825
				7.24	213TC	STD	90453-827
	350	230	5.00:1	5.98	182TC/184TC	80F	90453-840
				5.98	213TC	STD	90453-842
				16.01	215TC	STD	90453-845
				30.49	254TC/256TC	STD	90453-847
	278	183	6.30:1	5.94	182TC/184TC		90453-950
				13.36	213TC/215TC	80F	90453-952
				23.43	254TC/256TC		90453-953
219	144	8.00:1	9.47	182TC/184TC	80F	90453-956	
			18.48	213TC/215TC	80F	90453-957	
			18.48	254TC/256TC		90453-958	

(CONT'D)

① Listed reducer horsepower rated for Standard Service (8-10 hrs/day). For Light Service (3-5 hrs/day) multiply maximum rated horsepower by 1.1. For Heavy Service (16-24 hrs/day) multiply maximum rated horsepower by 0.9.

② Based on 1750 RPM input.

NOTE: CONSULT FACTORY FOR;

1. HORSEPOWERS & FRAMES NOT SHOWN
2. DRIP PAN BASES



GHS & GHA

SEC. 545

PAGE 22

January 2010

GRR REDUCER C-FLANGE FLEX DRIVE OPTIONS

(Drive Assy Number Includes Base, Coupling, Guard & Gear Reducer, But **NOT** the Motor)

PUMP MODEL NUMBER	PUMP RPM @1750	PUMP RPM @1150	REDUCER ①		FRAME	MTG. FT. OPTION	DRIVE ASSY NO.
			RATIO	MAX.HP			
GHS GHA R	700	460	2.50:1	13.96	213TC/215TC	STD	90453-861
				30.62	254TC/256TC	STD	90453-864
				30.62	284TC/286TC	STD	90453-869
	634	417	2.76:1	46.17	324TC/326TC	STD	90453-874
				75.00	364TC	STD	90453-878
	555	365	3.15:1	10.10	213TC/215TC	STD	90453-884
				25.76	254TC/256TC	STD	90453-886
				42.96	284TC/286TC	STD	90453-893
	530	348	3.38:1	66.20	324TC/326TC	STD	90453-898
	438	288	4.00:1	9.42	184TC	STD	90453-901
				20.00	213TC/215TC	STD	90453-904
				38.16	254TC/256TC	STD	90453-911
				38.16	284TC/286TC	STD	90453-916
	420	278	4.13:1	54.4	324TC/326TC	STD	90453-918
	350	230	5.00:1	6.10	184TC	STD	90453-921
				16.01	213TC/215TC	STD	90453-926
				30.49	254TC/256TC	STD	90453-929
				30.49	284TC/286TC	STD	90453-933
	278	184	6.30:1	5.94	184TC	STD	90453-940
				13.36	213TC/215TC	STD	90453-941
23.43				254TC/256TC	STD	90453-942	
219	145	8.00:1	9.47	184TC	STD	90453-944	
			18.48	213TC/215TC	STD	90453-946	
			18.48	254TC	STD	90453-947	

① Listed reducer horsepower rated for Standard Service (8-10 hrs/day). For Light Service (3-5 hrs/day) multiply maximum rated horsepower by 1.1. For Heavy Service (16-24 hrs/day) multiply maximum rated horsepower by 0.9.

② Based on 1750 RPM input.

NOTE: CONSULT FACTORY FOR;

1. HORSEPOWERS & FRAMES NOT SHOWN
2. DRIP PAN BASES



PERFORMANCE CURVES

SPEED VS. CAPACITY/HORSEPOWER

JP

Hydraulic
Size

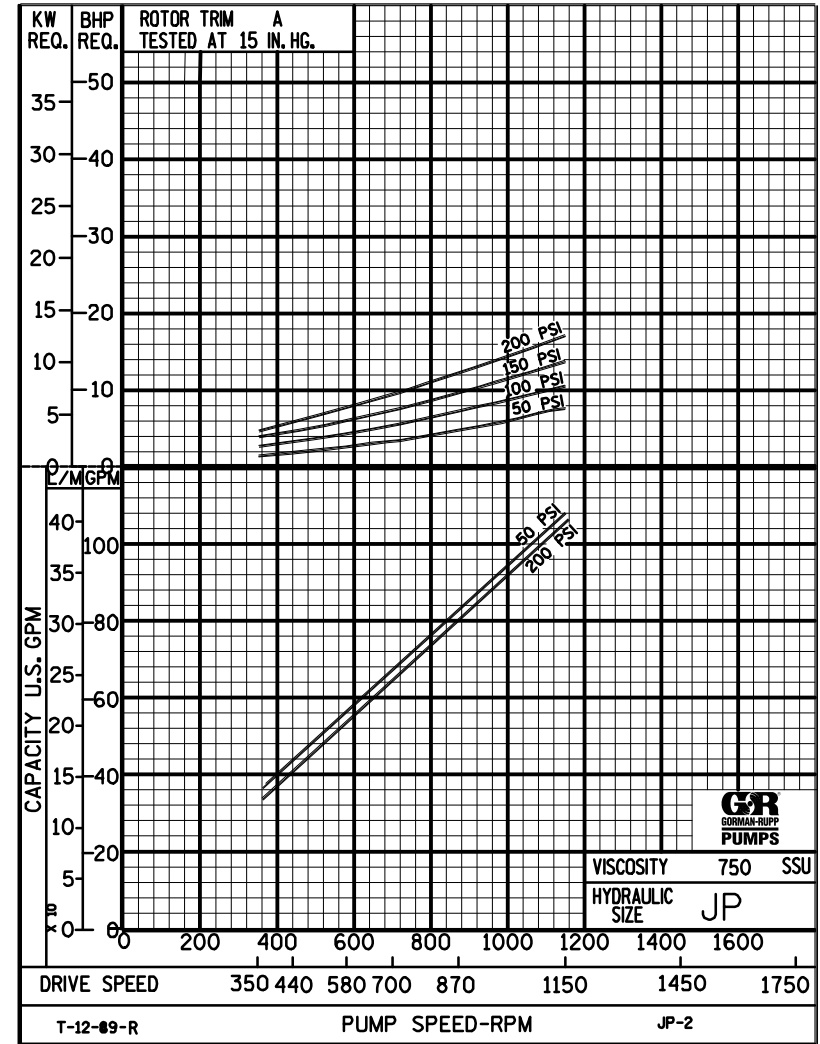
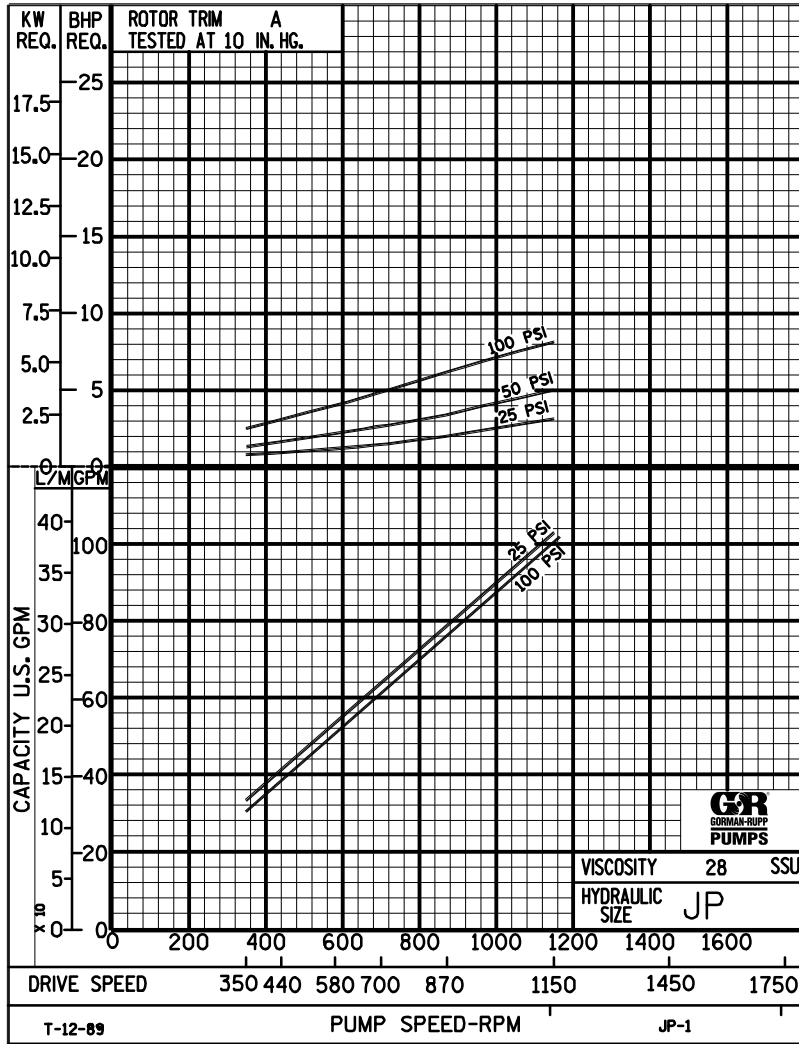

THE GORMAN-RUPP COMPANY • MANSFIELD, OHIO
 GORMAN-RUPP OF CANADA LIMITED • ST. THOMAS, ONTARIO, CANADA



PERFORMANCE CURVES

SPEED VS. CAPACITY/HORSEPOWER

JP Hydraulic Size

SEC. 500

Page 81

January 2010

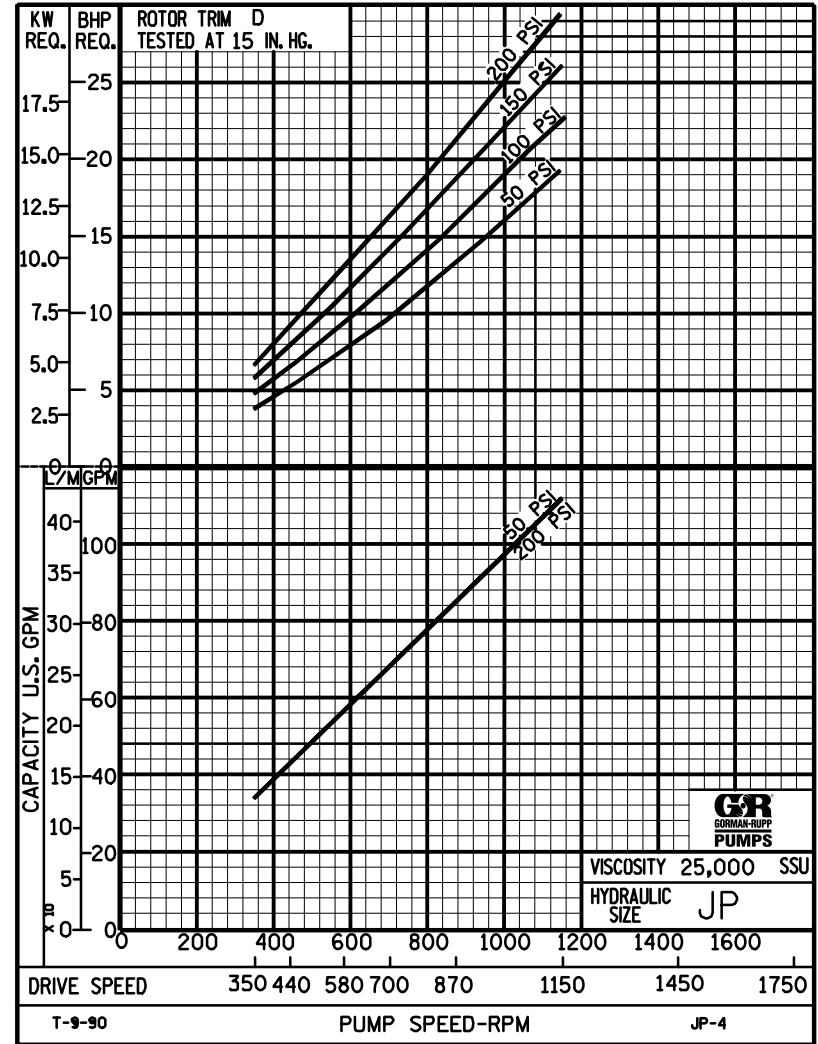
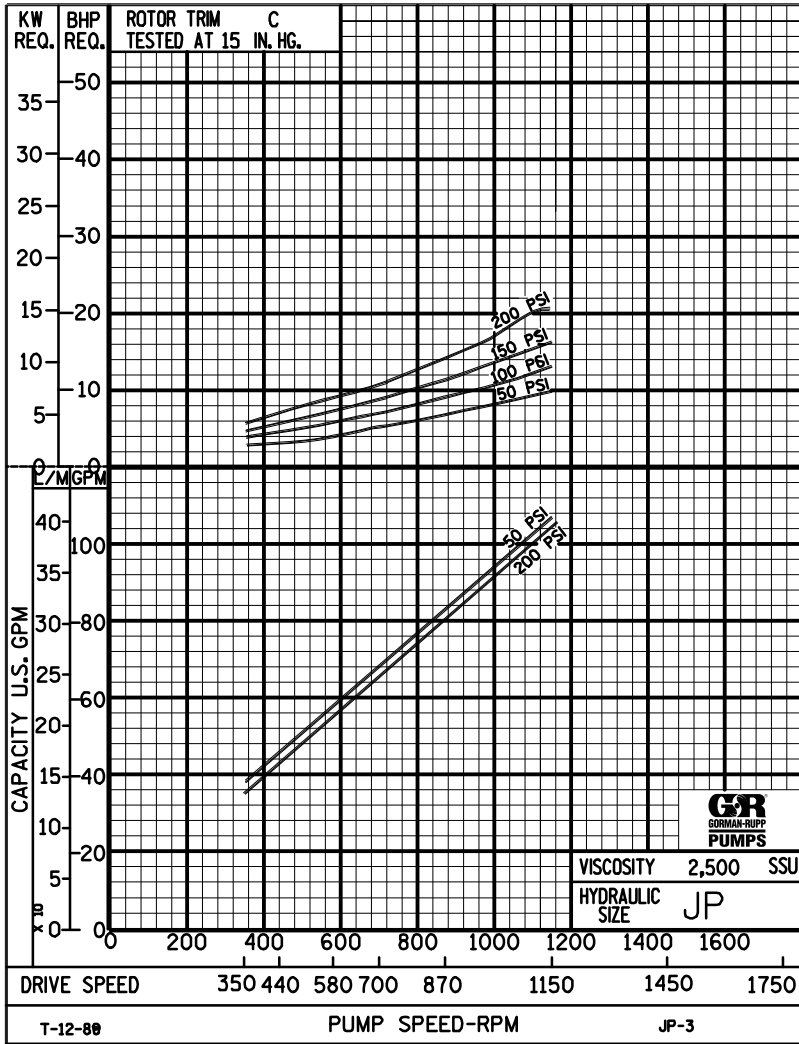

THE GORMAN-RUPP COMPANY • MANSFIELD, OHIO
 GORMAN-RUPP OF CANADA LIMITED • ST. THOMAS, ONTARIO, CANADA

Printed in U.S.A.

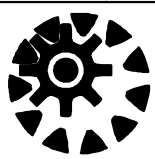

JP

PUMP HYDRAULIC SIZE CHART

SEC. 500

Page 82

January 2010

107 GPM
1150 RPM

NOMINAL		ROTOR TRIM	VISCOSITY (SSU)	N.I.P.R. (PSIA)	FRICTION PIPE LOSS (PSI/FT) <small>(Based on Sch 40 Steel Pipe)</small>					FULL BYPASS RELIEF VALVE PRESSURE (PSI)					CAPACITY (GPM) / H.P. REQUIRED									
CAP. GPM	SPEED RPM				PIPE DIAMETER					CRACKING PRESS. (PSI)					DIFFERENTIAL PRESSURE (PSI)									
					1½"	2"	2½"	3"	4"	LOW PRES R/V			HI PRES R/V		HEAVY DUTY									
							50	75	100	150	200	25	50	75	100	150	200	300	400					
107	1150	STD	28	4.8	.01	.01	.01	.01	.01	77	104	143			103	100	100	99						
			32		.23	.07	.03	.01	.01						3.2	5.0	6.3	8.1						
			38	4.8	.29	.09	.04	.02	.01	78	105	144	188			105	103	102	101	100				
			50		.34	.11	.05	.02	.01							3.5	5.5	6.8	8.6	12				
			70	4.8	.39	.12	.05	.02	.01	79	107	144	189	240			106	105	104	103	102	101		
			100		.44	.14	.06	.02	.01								3.8	6.0	7.4	9.1	13	16		
			150	4.8	.50	.15	.07	.03	.01	80	107	145	189	241			108	106	106	105	104	103		
			200		.54	.17	.07	.03	.01								4.1	6.5	8.0	9.6	13	16		
			300	4.8	.61	.19	.08	.03	.01	81	109	145	190	242			109	108	107	107	106	105		
			500		.64	.22	.09	.04	.01								4.4	7.1	8.5	10	14	17		
		750	4.8	.70	.26	.13	.06	.02	82	111	146	190	243			109	109	108	108	108	107			
		1,000		.94	.35	.17	.07	.03								4.7	7.6	9.1	11	14	17			
		2,000	5.7	1.87	.69	.34	.14	.05	86	118	153	196	252			109	109	109	108	108	108			
		3,500		3.28	1.21	.59	.25	.09								6.1	9.9	12	13	16	20			
		5,000	6.2	4.68	1.73	.85	.36	.12	90	123	156	200	256			110	110	109	109	109	109			
		7,500		7.02	2.59	1.27	.54	.18								9.9	13	15	16	20	23			
		10,000	6.8	9.36	3.45	1.70	.71	.24	96	129	160	204	260			110	110	110	109	109	109			
		15,000		14.1	5.17	2.54	1.07	.36								14	16	18	19	23	26			
		20,000	7.3	18.7	6.89	3.39	1.42	.48	102	135	164	208	264			111	110	110	110	109	109			
		25,000		23.4	8.62	4.23	1.78	.60								18	19	21	23	26	30			
50,000																								
75,000																								
100,000																								
150,000																								
200,000																								
250,000																								

(NOTE) For speeds not shown on the pump hydraulic charts, consult factory.



JP

PUMP HYDRAULIC SIZE CHART

SEC. 500

Page 83

January 2010

**81 GPM
870 RPM**

NOMINAL		ROTOR TRIM	VISCOSITY (SSU)	N.I.P.R. (PSIA)	FRICTION PIPE LOSS (PSI/FT) <small>(Based on Sch 40 Steel Pipe)</small>					FULL BYPASS RELIEF VALVE PRESSURE (PSI)					CAPACITY (GPM) / H.P. REQUIRED										
CAP. GPM	SPEED RPM				PIPE DIAMETER					CRACKING PRESS. (PSI)					DIFFERENTIAL PRESSURE (PSI)										
					1½"	2"	2½"	3"	4"	LOW PRES R/V			HI PRES R/V		MEDIUM DUTY AND HEAVY DUTY				HEAVY DUTY ONLY						
							50	75	100	150	200	25	50	75	100	150	200	300	400						
81	870	STD	28	3.0	.01	.01	.01	.01	.01	74	100	133			77	75	75	74							
			32		.14	.04	.02	.01	.01						2.2	3.4	4.7	6.0							
			38	3.0	.18	.06	.03	.01	.01	74	100	133	174			78	77	76	75	75					
			50		.21	.07	.03	.01	.01							2.3	3.7	5.0	6.2	7.5					
			70	3.0	.24	.08	.03	.01	.01	74	101	134	174	226			79	78	78	77	76	75			
			100		.27	.09	.04	.02	.01								2.5	4.0	5.2	6.5	8.0	10			
			150	3.0	.31	.10	.04	.02	.01	75	101	134	175	226			81	79	79	78	78	77			
			200		.34	.11	.05	.02	.01								2.6	4.3	5.5	6.8	8.6	11			
			300	3.0	.38	.12	.05	.02	.01	75	102	135	175	227			81	81	80	79	79	78			
			500		.44	.13	.07	.03	.01								2.8	4.5	5.8	7.0	9.2	12			
		750	3.0	.53	.20	.10	.04	.02	75	102	135	175	227			82	81	81	80	80.5	80				
		1,000		.71	.26	.13	.06	.02								3.0	4.8	6.0	7.3	9.7	12				
		2,000	3.7	1.42	.52	.26	.11	.04	76	104	137	177	229			82	82	81	81	81	81				
		3,500		2.48	.92	.45	.19	.07								4.2	6.8	7.9	9.0	12	14				
		5,000	4.2	3.55	1.31	.64	.27	.09	80	109	139	179	231			83	83	82	82	82	82				
		7,500		5.32	1.96	.96	.41	.14								6.8	9.0	10	11	14	16				
		10,000	4.6	7.09	2.61	1.28	.54	.18	84	114	143	183	235			84	84	83	83	83	82				
		15,000		10.7	3.92	1.92	.81	.27								9.3	11	12	14	16	19				
		20,000	5.0	14.2	5.22	2.57	1.08	.37	89	120	149	187	241			85	84	84	84	84	83				
		25,000		17.7	6.52	3.21	1.35	.46								12	13	14	16	18	21				
50,000	7.6	35.5	13.1	6.41	2.69	.91	95	126	155	193	247			85	84	84	84	84	83						
75,000		-	-	-	-	-								17	18	21	23	24	27						
100,000																									
150,000																									
200,000																									
250,000																									

(NOTE) For speeds not shown on the pump hydraulic charts, consult factory.



JP

PUMP HYDRAULIC SIZE CHART

SEC. 500

Page 84

January 2010

**54 GPM
580 RPM**

NOMINAL		ROTOR TRIM	VISCOSITY (SSU)	N.I.P.R. (PSIA)	FRICTION PIPE LOSS (PSI/FT) <small>(Based on Sch 40 Steel Pipe)</small>					FULL BYPASS RELIEF VALVE PRESSURE (PSI)					CAPACITY (GPM) / H.P. REQUIRED								
CAP. GPM	SPEED RPM				PIPE DIAMETER					CRACKING PRESS. (PSI)					DIFFERENTIAL PRESSURE (PSI)								
					1½"	2"	2½"	3"	4"	LOW PRES R/V			HI PRES R/V		MEDIUM DUTY AND HEAVY DUTY				HEAVY DUTY ONLY				
							50	75	100	150	200	25	50	75	100	150	200	300	400				
54	580	STD	28	1.9	.01	.01	.01	.01	.01	62	87	114			51	50	50	49					
			32		.07	.02	.01	.01	.01							1.5	2.3	3.1	4.0				
			38	1.9	.09	.03	.01	.01	.01	62	89	116	166			52	51	51	50	50			
			50		.10	.03	.02	.01	.01							1.6	2.5	3.3	4.2	5.0			
			70	1.9	.12	.04	.02	.01	.01	63	90	118	167	219			53	52	52	51	51	50	
			100		.14	.04	.02	.01	.01							1.7	2.7	3.5	4.4	5.4	6.9		
			150	1.9	.16	.05	.02	.01	.01	64	91	120	167	219			54	53	53	52	52	51	
			200		.17	.05	.02	.01	.01							1.8	2.9	3.7	4.5	5.8	7.3		
			300	1.9	.19	.06	.03	.01	.01	65	92	122	168	220			54	54	53	53	53	52	
			500		.24	.09	.05	.02	.01							1.9	3.0	3.9	4.7	6.2	7.8		
		750	1.9	.36	.13	.07	.03	.01	66	93	124	168	220			54	54	54	54	54	53		
		1,000		.47	.18	.09	.04	.01							2.0	3.2	4.0	4.9	6.5	8.2			
		2,000	2.6	.95	.35	.17	.07	.03	70	95	124	168	222			55	55	54	54	54	54		
		3,500		1.66	.61	.30	.13	.04							2.8	4.6	5.3	6.1	7.8	9.5			
		5,000	3.0	2.36	.87	.43	.18	.06	72	97	126	170	224			55	55	55	55	55	54		
		7,500		3.55	1.31	.64	.27	.09							4.6	6.0	6.8	7.6	9.3	11			
		10,000	3.5	4.73	1.74	.86	.36	.12	74	99	128	172	226			56	56	56	55	55	55		
		15,000		7.09	2.61	1.28	.54	.18							6.3	7.4	8.2	9.1	11	13			
		20,000	3.9	9.45	3.48	1.71	.72	.24	78	103	128	174	226			57	56	56	56	56	56		
		25,000		11.8	4.35	2.14	.90	.30							8.0	8.9	9.6	11	12	14			
50,000	6.1	23.6	8.70	4.27	1.79	.61	82	107	132	178	230			57	56	56	56	56	56				
75,000		35.5	13.1	6.41	2.69	.91							11	12	14	16	16	18					
100,000																							
150,000																							
200,000																							
250,000																							

(NOTE) For speeds not shown on the pump hydraulic charts, consult factory.



JP

PUMP HYDRAULIC SIZE CHART

SEC. 500

Page 85

January 2010

**32 GPM
350 RPM**

NOMINAL		ROTOR TRIM	VISCOSITY (SSU)	N.I.P.R. (PSIA)	FRICTION PIPE LOSS (PSI/FT) <small>(Based on Sch 40 Steel Pipe)</small>					FULL BYPASS RELIEF VALVE PRESSURE (PSI)					CAPACITY (GPM) / H.P. REQUIRED															
CAP. GPM	SPEED RPM				PIPE DIAMETER					CRACKING PRESS. (PSI)					DIFFERENTIAL PRESSURE (PSI)															
					1½"	2"	2½"	3"	4"	LOW PRES R/V			HI PRES R/V		MEDIUM DUTY AND HEAVY DUTY				HEAVY DUTY ONLY											
32	350	STD	28	1.3	.01	.01	.01	.01	.01	56	82	113			31	30	30	29												
			32		.03	.01	.01	.01	.01						.89	1.4	1.9	2.4												
			38	1.3	.04	.01	.01	.01	.01	56	82	113	159			31	31	30	30	30										
			50		.04	.02	.01	.01	.01							.94	1.5	2.0	2.5	3.0										
			70	1.3	.05	.02	.01	.01	.01	56	83	113	159	211			32	31	31	31	30.7	30.4								
			100		.06	.02	.01	.01	.01								1.0	1.6	2.1	2.6	3.2	4.1								
			150	1.3	.06	.02	.01	.01	.01	56	83	113	159	211			32	32	31	31	31	31								
			200		.06	.02	.01	.01	.01								1.1	1.7	2.2	2.7	3.5	4.4								
			300	1.3	.09	.03	.02	.01	.01	57	84	113	159	211			32	32	32	32	32	31								
			500		.14	.05	.03	.01	.01								1.1	1.8	2.3	2.8	3.7	4.7								
		750	1.3	.21	.08	.04	.02	.01	57	84	113	159	211			32	32	32	32	32	32									
		1,000		.28	.11	.05	.02	.01								1.2	1.9	2.4	2.9	3.9	5.0									
		2,000	2.0	.56	.21	.10	.04	.02	59	86	115	159	211			33	33	32	32	32	32									
		3,500		.98	.36	.18	.08	.03								1.7	2.7	3.2	3.6	4.7	5.7									
		5,000	2.4	1.40	.52	.26	.11	.04	61	88	117	160	212			33	33	33	33	33	32									
		7,500		2.10	.78	.38	.16	.06								2.7	3.6	4.1	4.5	5.6	6.6									
		10,000	2.9	2.80	1.03	.51	.21	.07	63	90	120	161	213			33	33	33	33	33	33									
		15,000		4.20	1.55	.76	.32	.11								3.8	4.5	4.9	5.4	6.5	7.5									
		20,000	3.2	5.60	2.06	1.02	.43	.15	66	93	123	161	213			34	34	34	33	33	33									
		25,000		7.00	2.58	1.27	.53	.18								4.8	5.3	5.8	6.3	7.4	8.4									
50,000	5.4	14.0	5.16	2.53	1.06	.36	69	96	126	164	216			34	34	34	33	33	33											
75,000		21.0	7.73	3.80	1.60	.54								6.7	7.3	8.2	9.4	9.8	11											
100,000	8.0	28.0	10.3	5.07	2.13	.72	73	100	130	168	220			34	34	34	33	33	33											
150,000		42.0	15.5	7.60	3.19	1.08								8.1	8.8	10	11	12	13											
200,000																														
250,000																														

(NOTE) For speeds not shown on the pump hydraulic charts, consult factory.



JP

SEC. 500

PAGE 85.1

February 2025

15 GPM
150 RPM

NOMINAL		VISCOSITY		N.I.P.R.	FRICTION PIPE LOSS (PSI/FT) <small>(Schedule 40 Steel Pipe)</small>					CAPACITY (GPM)				H.P. REQUIRED							
GPM	RPM	ROTOR TRIM	(SSU)	(PSIa)	PIPE DIAMETER					MEDIUM-DUTY & HEAVY-DUTY				HEAVY-DUTY ONLY							
					2"	2½"	3"	4"	5"	DIFFERENTIAL PRESSURE (PSI)											
										25	50	75	100	150	200	300	400				
15	150	STD																			
				"D"																	
					200,000	3.7	9.7	4.8	2	0.7	0.3	15.1	15.1	15.0	15.0	14.8	14.8	14.7	14.5		
					399,999		19.3	9.5	4	1.3	0.6	2.6	2.8	3.1	3.3	3.5	3.9	4.5	5.0		
					400,000	4.2						15.1	15.1	15.0	15.0	14.8	14.8	14.7	14.5		
					599,999		NR	14.3	6	2	0.8	2.8	3.0	3.3	3.5	3.7	4.1	4.7	5.2		
			600,000	5.1	NR					15.1	15.1	15.0	15.0	14.8	14.8	14.7	14.5				
			799,999		NR	19	8	2.7	1.1	3.0	3.2	3.5	3.7	3.9	4.3	4.9	5.4				
			800,000	5.6	NR					15.1	15.1	15.0	15.0	14.8	14.8	14.7	14.5				
			1M		NR	23.8	10	3.4	1.4	3.3	3.5	3.8	4.0	4.2	4.6	5.2	5.7				

(NOTE) For speeds not shown on the pump hydraulic charts, consult factory.