

GMS SERIES
MEDIUM DUTY STANDARD
S & T HYDRAULIC SIZE
ROTARY GEAR PUMP



MODEL GMS6SU3
SHOWN WITH OPTIONAL
180° HOUSING

The GMS iron, high capacity series is designed for applications in the operating ranges noted below. These units are ideal for bulk handling of a variety of liquids. For temperature control, backhead and housing jackets are standard; head jackets are available. Also available are carbon graphite bushings for low viscosity liquids, silicon carbide bushings for wear resistance, and carbide or positive drive shaft seals.

For continuous service, or for handling difficult liquids, see the heavy duty GHS section.

For belt drive applications, a pedestal bearing is required.

FEATURES

*THRUST CONTROLLED PUMP
 ELEMENTS*

*HIGH STRENGTH, COMPUTER
 PROFILED GEARING FOR QUIET
 OPERATION*

*SEAL AREA FULLY JACKETED FOR
 TEMPERATURE CONTROL.*

EXCEPTIONAL SEAL VERSATILITY.

OPERATING RANGE

CAPACITY (GPM): (40 TO 600)
 [LPM] : [151 TO 2270]

PRESSURE (PSI) : [0 TO 100]
 [BAR] : [0 TO 7]

VISCOSITY (SSU) : (28 TO 250,000)
 [cSt] : [1 TO 55,000]

TEMPERATURE (F) : (-60° TO 500°)
 [C] : [-51° TO 260°]

APPLICATIONS

USE WITH ANY CLEAN LIQUID
 COMPATIBLE WITH CAST
 IRON

- ★ BOOSTER SERVICE
- ★ CIRCULATING
- ★ FILTERING
- ★ LUBRICATING
- ★ TRANSFERRING

THE GORMAN-RUPP COMPANY • MANSFIELD, OHIO

GORMAN-RUPP OF CANADA LIMITED • ST. THOMAS, ONTARIO, CANADA

EXTERIOR	ROTOR & IDLER	HOUSING PORTS	BUSHINGS	IDLER PIN	SHAFT	SHAFT SEALING		ROTATION	INTERNAL RELIEF VALVE	
						MECH. SEAL	PACKING		MATERIAL	SETTING
CAST IRON	HIGH STRENGTH IRON	90° 125# FLG	BRONZE	HARDENED STEEL	STEEL	FLUORO ^① CARBON NI-RESIST	CARBON FIBER	C.W.	CAST IRON	75 PSI [5 BAR]

Standard Models

G M S 4 SU 3 - B
 | | | | | | | | | | | |
 GEAR DUTY DESIGN PORT SIZE HYDRAULIC SEAL STYLE
 SIZE SIZE

MODEL NUMBER	NOM. CAPACITY - SPEED		MAXIMUM			TEMP.	SHIPPING DATA	
	MAXIMUM		DIFFERENTIAL PRESSURE-PSI [BAR]				Weight LBS [KG]	Volume CU. FT.
	GPM [LPM]	RPM	BELOW 38 SSU 14 cSt	38 TO 100 SSU [21 cSt]	100 TO 250,000 SSU [55,000 cSt]	°F [°C]		
GMS 3 SR3-B ● GMS 3 SR4-B ■	202 [765]	350	50 [3.5]	75 [5.2]	100 [7]	400° [204]	515 [234]	17.3
GMS 4 SR3-B ● GMS 4 SR4-B ■								
GMS 6 SR3-B ● † GMS 6 SR4-B ■ †								
GMS 3 SU3-B ● GMS 3 SU4-B ■								
GMS 4 SU3-B ● GMS 4 SU4-B ■								
GMS 6 SU3-B ● † GMS 6 SU4-B ■ †								
GMS 5 TU3-B ● GMS 5 TU4-B ■	600 [2270]	350	50 [3.5]	75 [5.2]	100 [7]	500° [260]	715 [324]	17.3
GMS 6 TU3-B ● GMS 6 TU4-B ■								

● MECHANICAL SEAL

■ PACKING

† PORTS ARE COMPATIBLE WITH 125# ANSI CAST IRON FLANGES.

† 180° DEGREE HOUSING

* Note: Verify chemical compatibility

① DUPONT VITON® OR EQUIVALENT

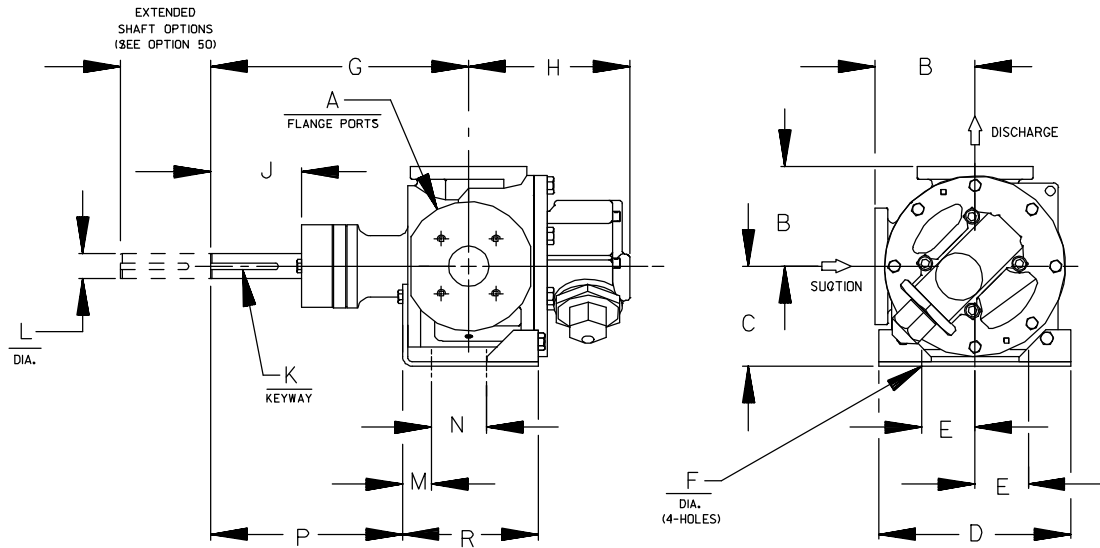

CAD FILE NO.: 17221A

PUMP MODEL	PUMP DIMENSIONS - INCHES [MILLIMETERS]														
	A	B	C	D	E	F	G	H	J	K	L	M	N	P	R
GMS S	3.00*	7.75 [197]	7.75 [197] *	8.25 [210]	4.12 [105]	.69 [18]	20.00 [508]	12.49 [317]	6.90 [178]	.50 [13]	1.94 [49]	2.88 [73]	4.25 [108]	14.00 [356]	11.41 [290]
	4.00*	8.25 [210]								x					
	6.00*	9.00 [229] †	8.75 [222]							5.00 [127]					
GMS T	5.00*	9.56 [243]	9.50 [241]	12.00 [304,8]	5.00 [127]	.69 [18]	20.70 [526]	12.41 [315]	7.00 [178]	.62 [16]	2.44 [62]	.81 [21]	6.25 [159]	16.45 [418]	8.50 [216]
	6.00*	9.52 [244]								x					
	6.00*	9.75 [248] †								4.62 [117]					

* STANDARD DIMENSION

† 180° HOUSING

THE GORMAN-RUPP COMPANY • MANSFIELD, OHIO
GORMAN-RUPP OF CANADA LIMITED • ST. THOMAS, ONTARIO, CANADA

GRR REDUCER C-FLANGE FLEX DRIVE OPTIONS

(Drive Assembly Number Includes Base, Coupling, Guard and Gear Reducer, But **NOT** the Motor)

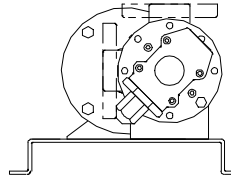
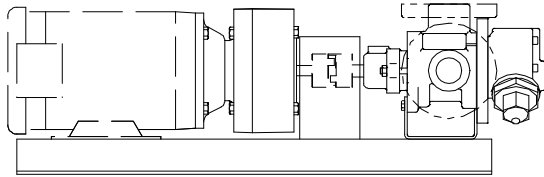

CAD FILE NO.: 16573

PUMP MODEL	RPM @ 1750	RPM @ 1150	REDUCER ①		FRAME	MTG.FT. OPTION REQ.	DRIVE ASSY NO.	
				MAX HP @ 1750				MAX HP @ 1150
GMS S	343	225	5.10:1	20.00	13.20	254TC/256TC	STD	90253-004
	344	226	5.08:1	30.00	19.80	284TC/286TC	STD	90253-006
	355	233	4.93:1	60.00	39.60	324TC	STD	90253-008
	283	186	6.19:1	20.00	13.20	254TC/256TC	STD	90253-014
	287	189	6.09:1	30.00	19.80	284TC/286TC	STD	90253-016
	276	181	6.35:1	60.00	39.60	324TC	STD	90253-018
	179	117	9.80:1	10.00	6.60	213TC	STD	90253-024
	206	135	8.50:1	20.00	13.20	254TC	STD	90253-026
				20.00	13.20	256TC	STD	90253-027
	198	130	8.83:1	30.00	19.80	284TC	STD	90253-028
				30.00	19.80	286TC	STD	90253-029
	120	79	14.55:1	10.00	6.60	213TC	STD	90253-034
	125	82	14.00:1	30.00	19.80	254TC	STD	90253-036
				30.00	19.80	256TC	STD	90253-037
105	69	16.66:1	7.81	5.16	184TC	STD	90253-044	
			17.71:1	16.48	10.88	213TC	STD	90253-046
99	65	17.81:1	26.41	17.43	254TC	STD	90253-048	
GMS T	279	186	6.19:1	20.00	13.20	254TC/256TC	STD	90253-104
	287	189	6.09:1	30.00	19.80	284TC/286TC	STD	90253-106
	276	181	6.35:1	60.00	39.60	324TC	STD	90253-108
				60.00	39.60	326TC	STD	90253-109
				60.00	39.60	364TC	STD	90253-110
	179	117	9.80:1	10.00	6.60	213TC	STD	90253-114
	206	135	8.50:1	20.00	13.20	254TC/256TC	STD	90253-116
	198	130	8.83:1	30.00	19.80	284TC	STD	90253-118
				30.00	19.80	286TC	STD	90253-119
	199	131	8.78:1	60.00	39.60	324TC	STD	90253-120
	119	79	14.55:1	10.00	6.60	213TC	STD	90253-124
	125	82	14.00:1	30.00	19.80	254TC/256TC	STD	90253-126
				30.00	19.80	284TC	STD	90253-128
	104	69	16.66:1	7.81	5.16	184TC	STD	90253-134
17.71:1				16.48	10.88	213TC	STD	90253-136
97	65	17.81:1	26.41	17.43	254TC/256TC	STD	90253-138	

① Listed reducer horsepower rated for Standard Service (8-10 hrs/day). For Light Service (3-5 hrs/day) multiply maximum rated horsepower by 1.1. For Heavy Service (16-24 hrs/day) multiply maximum rated horsepower by 0.9.

NOTE: CONSULT FACTORY FOR OPTIONS NOT SHOWN.



PERFORMANCE CURVES

SPEED VS. CAPACITY/HORSEPOWER

SU

Hydraulic Size

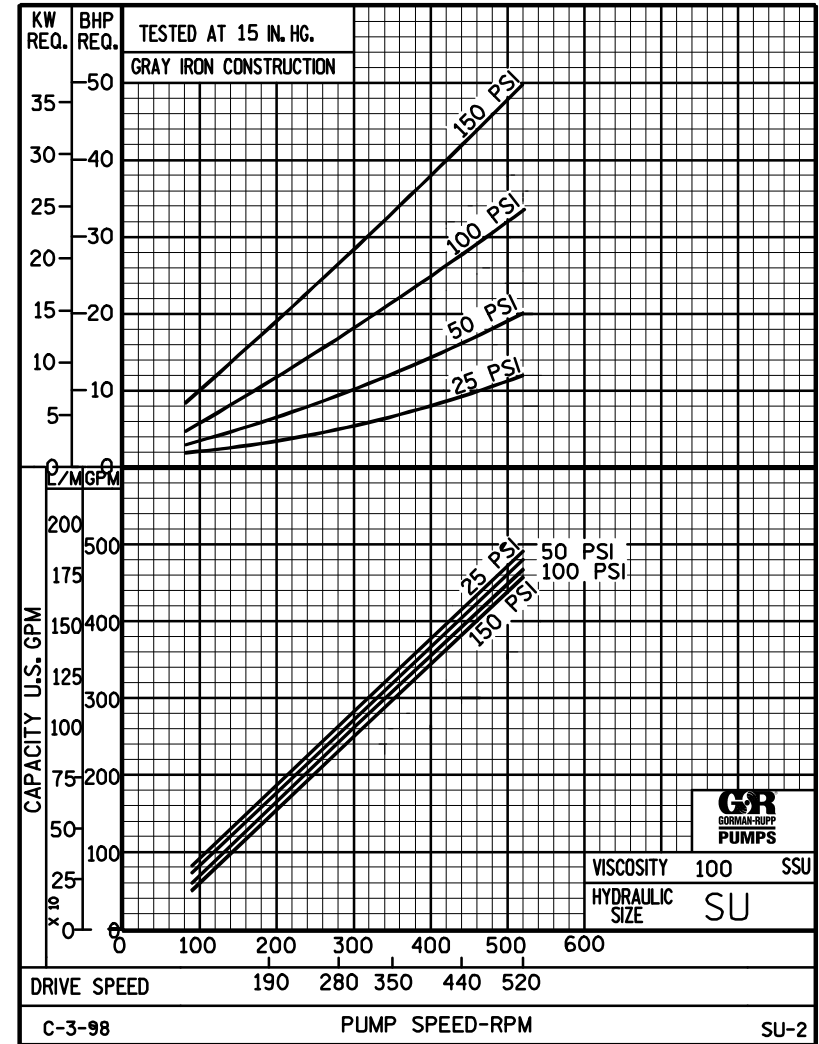
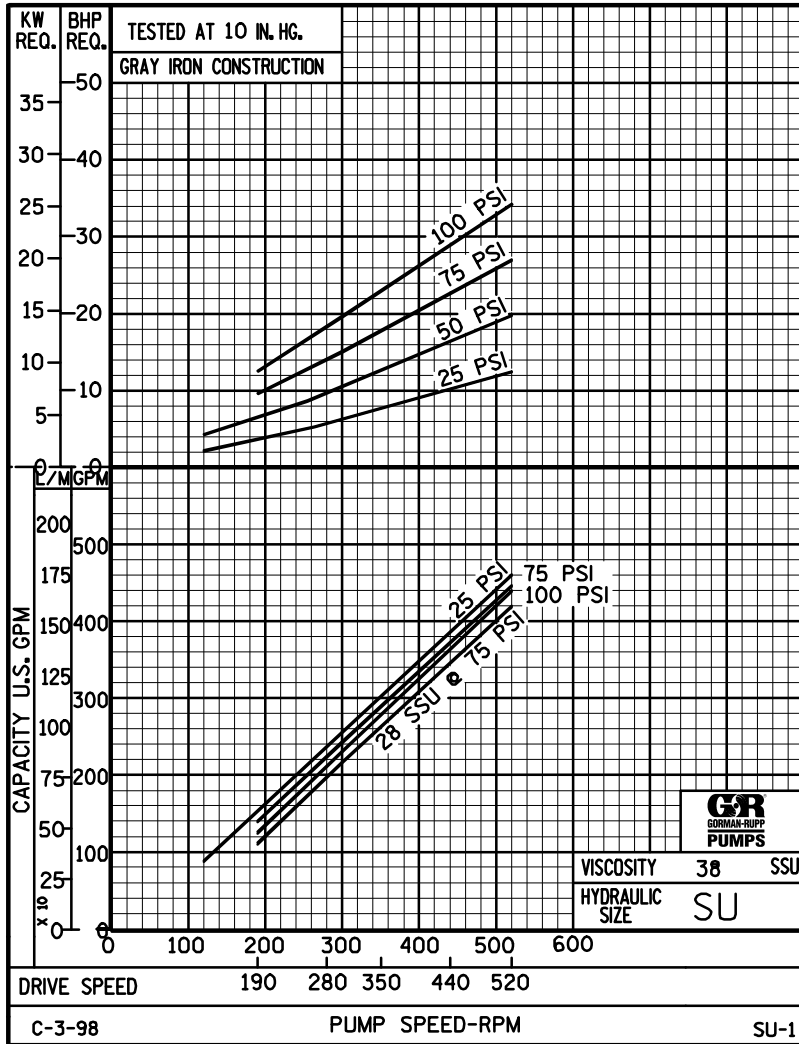

THE GORMAN-RUPP COMPANY • MANSFIELD, OHIO
 GORMAN-RUPP OF CANADA LIMITED • ST. THOMAS, ONTARIO, CANADA

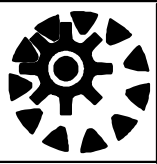

PERFORMANCE CURVES

SPEED VS. CAPACITY/HORSEPOWER

SU

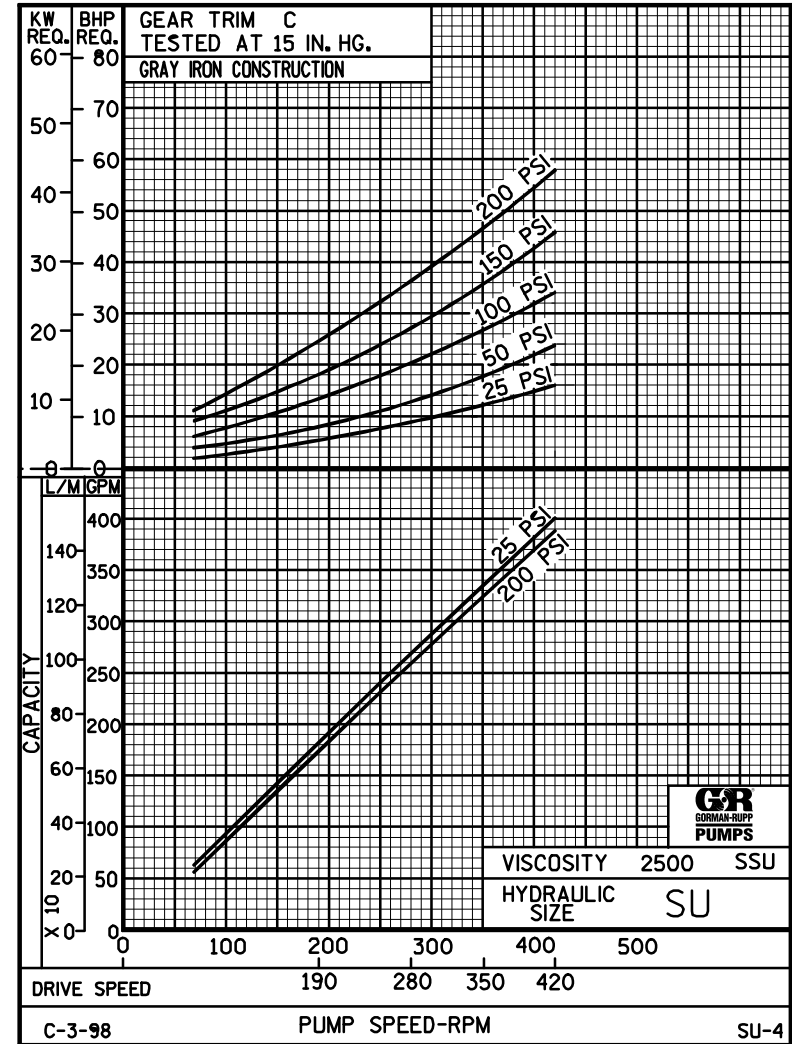
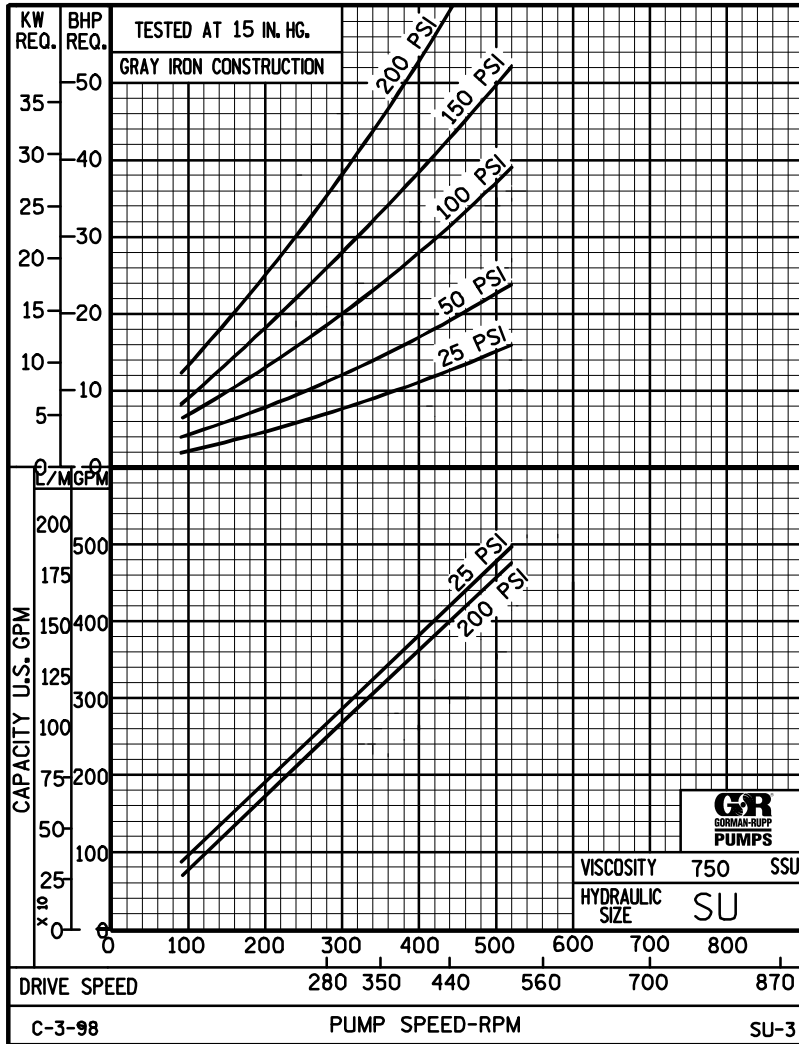
 Hydraulic Size

THE GORMAN-RUPP COMPANY • MANSFIELD, OHIO
 GORMAN-RUPP OF CANADA LIMITED • ST. THOMAS, ONTARIO, CANADA



PERFORMANCE CURVES

SPEED VS. CAPACITY/HORSEPOWER

SU

Hydraulic Size

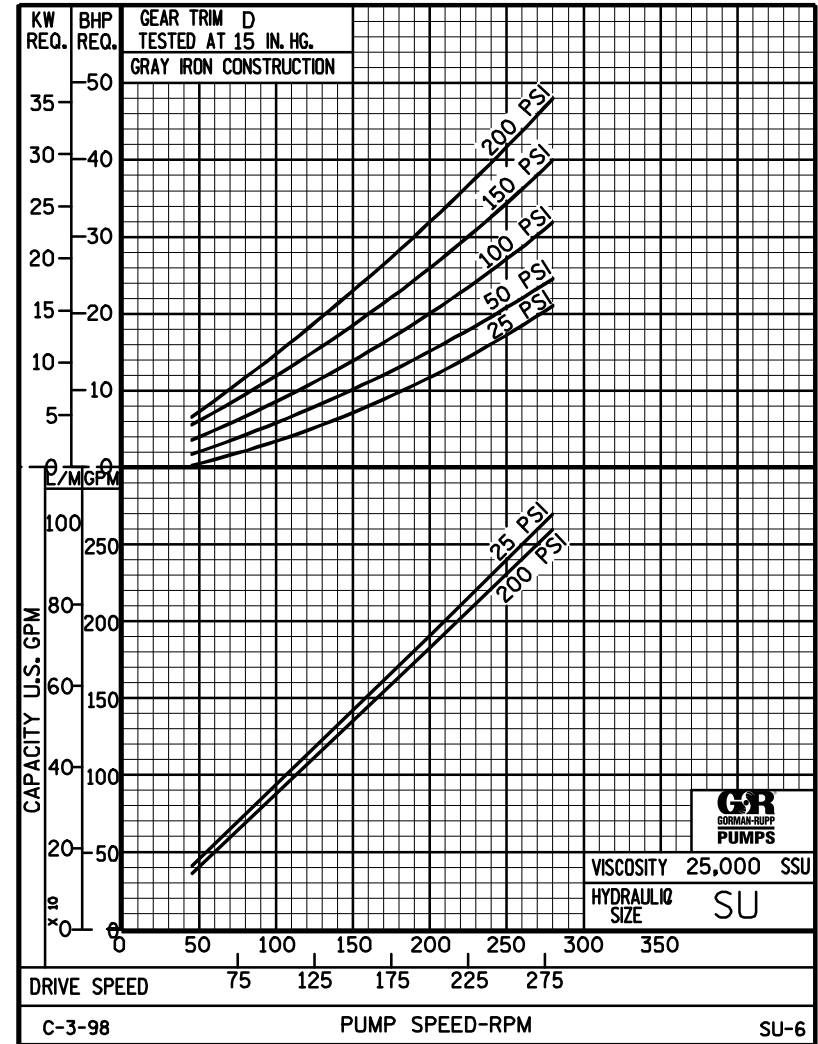
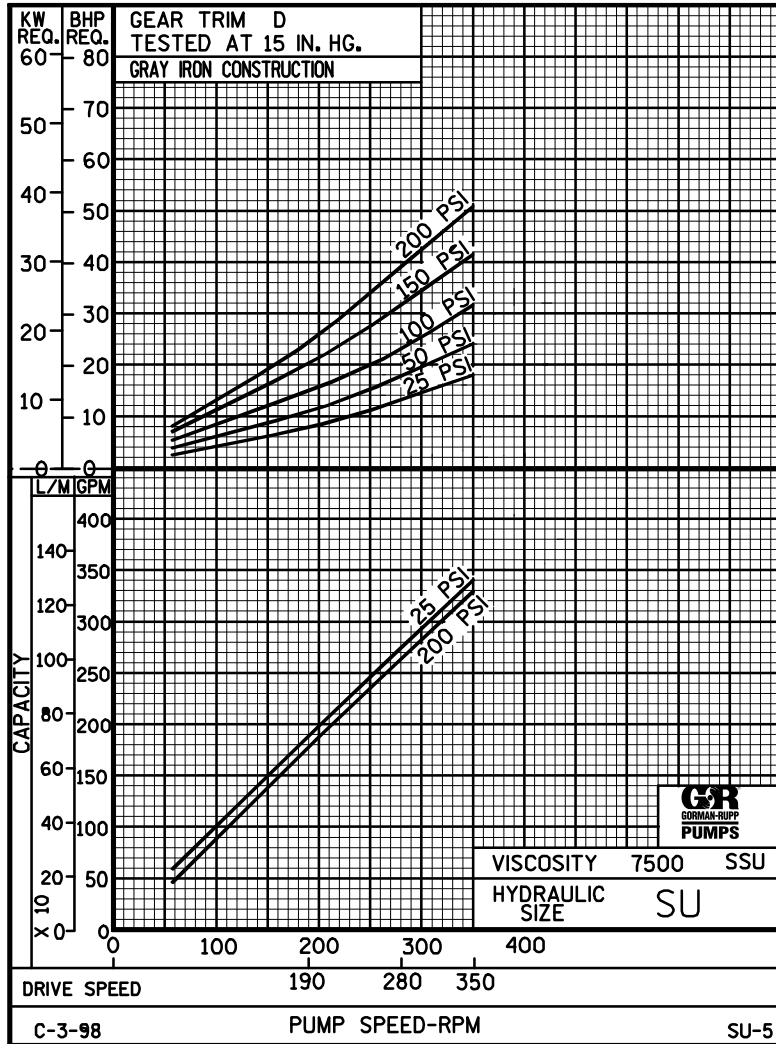

THE GORMAN-RUPP COMPANY • MANSFIELD, OHIO
GORMAN-RUPP OF CANADA LIMITED • ST. THOMAS, ONTARIO, CANADA

Printed in U.S.A.



PERFORMANCE CURVES

SPEED VS. CAPACITY/HORSEPOWER

SU Hydraulic Size

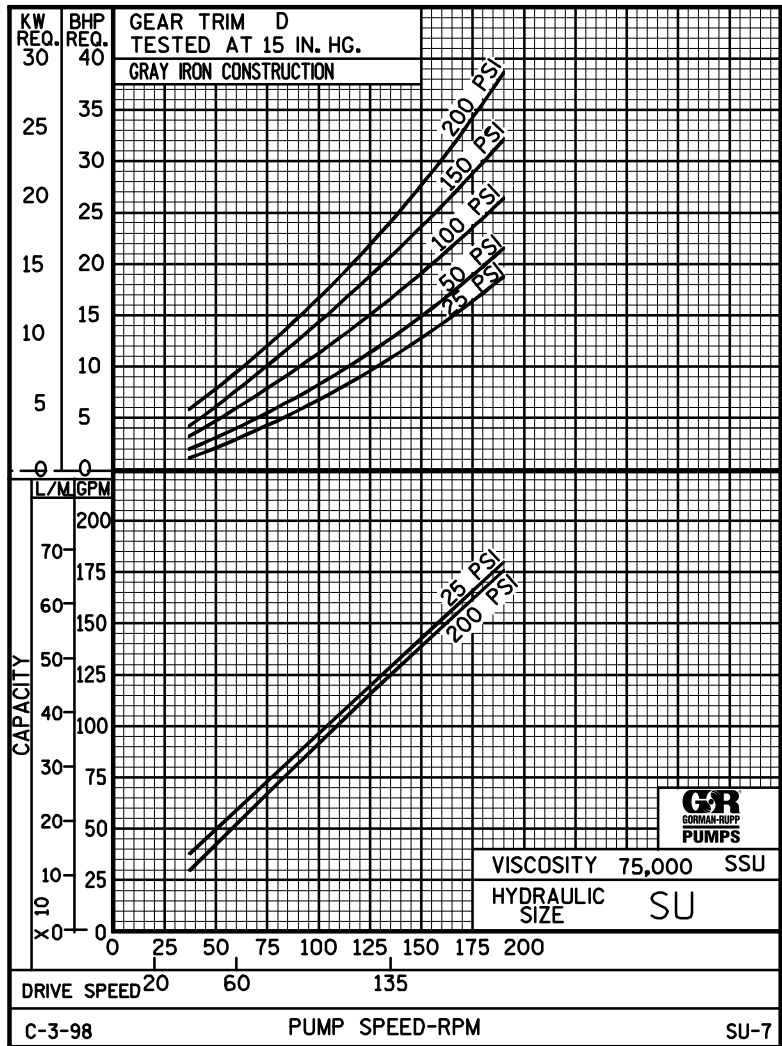

THE GORMAN-RUPP COMPANY • MANSFIELD, OHIO
GORMAN-RUPP OF CANADA LIMITED • ST. THOMAS, ONTARIO, CANADA

Printed in U.S.A.