

**GMS SERIES**  
**MEDIUM DUTY STANDARD;**  
**D, G, J, N & R SIZE**  
**ROTARY GEAR PUMP**

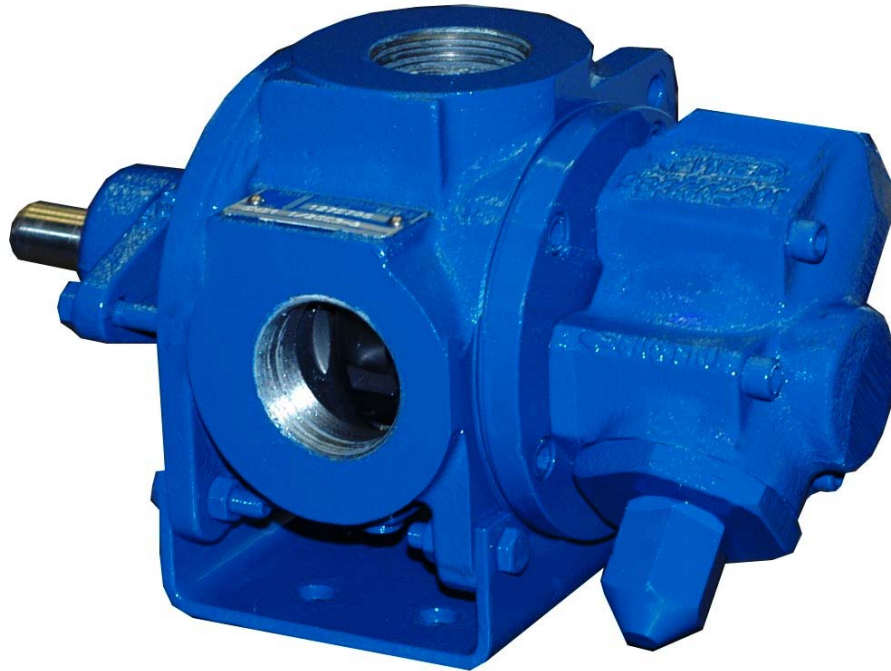

The GMS series is designed for applications in the operating ranges noted below. These units are available with head and backhead jackets (R size only) for temperature control, carbon graphite bushings for low viscosity liquids, silicon carbide bushings for wear resistance, and carbide, positive drive or packing seals for viscous sealing.

For continuous service, or for handling more viscous liquids, see the heavy duty GHS section.

For belt driven applications, select an extended shaft option and consult factory for availability of drive assembly. A pedestal bearing is required for belt driven applications.

**FEATURES**

*150 PSI CAPABILITY*  
*SELF-CONTAINED, NO EXTERNAL BEARING REQUIRED (UNLESS BELT DRIVEN)*  
*HIGH STRENGTH, COMPUTER PROFILED GEARING FOR QUIET OPERATION*  
*THRUST CONTROLLED PUMP ELEMENTS*  
*EXCEPTIONAL SEAL VERSATILITY*

**OPERATING RANGE**

CAPACITY (GPM) : (3 TO 265)  
 [LPM] : [11 TO 930]

PRESSURE (PSI) : (0 TO 150)  
 [BAR] : [0 TO 10.3]

VISCOSITY (SSU) : (28 TO 250,000)  
 [cSt] : [1 TO 55,000]

TEMPERATURE (F) : (-60° TO 450°)  
 [C] : [-51° TO 230°]

**APPLICATIONS**

- ★ BOOSTER SERVICE
- ★ CIRCULATING
- ★ FILTERING
- ★ LUBRICATING
- ★ TRANSFERRING

EXT.	ROTOR & IDLER	HOUSING PORTS	BUSHINGS	IDLER PIN	SHAFT	SHAFT SEALING		ROT.	INTERNAL RELIEF VALVE	
						MECH. SEAL ●	PACKING ■		MATERIAL	SETTING
CAST IRON	HIGH STRENGTH IRON	90° TAPPED	BRONZE	HARDENED STEEL		FLUORO <sup>①</sup> CARBON, NI-RESIST	PTFE, <sup>②</sup> GRAPHITE	C.W.	DUCTILE IRON	75 PSI [5 BAR]

## Standard Models

**G M S 1 DC 3 - B**  
 GEAR DUTY DESIGN PORT SIZE HYDRAULIC SEAL STYLE

MODEL NUMBER	NOM. CAPACITY - SPEED				MAXIMUM				SHIPPING DATA	
	MAXIMUM		ALTERNATIVE		DIFFERENTIAL PRESSURE-PSI [BAR]			TEMP.	Weight	Volume
	GPM	RPM	GPM	RPM	BELOW	38 TO	100 TO	°F	LBS	CU. FT.
	[LPM]	60 Hz [50 Hz]	[LPM]	60 Hz [50 Hz]	38 SSU [4 cSt]	100 SSU [21 cSt]	250,000 SSU [55,000 cSt]	[°C]	[KG]	FT.
<b>GMS 1DC 3-B</b> ● <b>GMS 1DC 4-B</b> ■	9 [28]		6 [19]						19 [8,6]	0.6
<b>GMS 1DE 3-B</b> ● <b>GMS 1DE 4-B</b> ■	11 [35]		7 [22]						19 [8.6]	0.6
<b>GMS 1-1/2 GC 3-B</b> ● <b>GMS 1-1/2 GC 4-B</b> ■	16 [50]		10 [32]						32 [14,5]	2.9
<b>GMS 2 GC 3-B</b> ● <b>GMS 2 GC 4-B</b> ■									32 [14,5]	2.9
<b>GMS 1-1/2 GF 3-B</b> ● <b>GMS 1-1/2 GF 4-B</b> ■	23 [73]	1750 [1460]	15 [47]	1150 [960]				400 [205]	32 [14,5]	2.9
<b>GMS 2 GF 3-B</b> ● <b>GMS 2 GF 4-B</b> ■					50 [3]	75 [5]	150 [10.3]		32 [14,5]	2.9
<b>GMS 1-1/2 GH 3-B</b> ● <b>GMS 1-1/2 GH 4-B</b> ■	31 [98]		20 [63]						32 [14,5]	2.9
<b>GMS 2 GH 3-B</b> ● <b>GMS 2 GH 4-B</b> ■								450 [230]	32 [14,5]	2.9
<b>GMS 1-1/2 GJ 3-B</b> ● <b>GMS 1-1/2 GJ 4-B</b> ■	38 [120]		25 [79]						32 [14,5]	2.9
<b>GMS 2 GJ 3-B</b> ● <b>GMS 2 GJ 4-B</b> ■									32 [14,5]	2.9
<b>GMS 2 JG 3-B</b> ● <b>GMS 2 JG 4-B</b> ■									83 [37,6]	2.9
<b>GMS 2-1/2 JG 3-B</b> ● <b>GMS 2-1/2 JG 4-B</b> ■	33 [126]	960 [960]	30 [95]	870 [725]					83 [37,6]	2.9
<b>GMS 3 JG 3-B</b> ● <b>GMS 3 JG 4-B</b> ■									83 [37,6]	2.9
STANDARD MODELS CONT.										

**NOTE:** RECOMMENDED PORT SIZES ARE SHOWN IN **BOLDFACE**. EXAMPLE: **GMS 2GJ3-B**

● MECHANICAL SEAL

■ PACKING/LIPSEAL

① DUPONT VITON<sup>®</sup> OR EQUIVALENT

② DUPONT TEFLON<sup>®</sup> OR EQUIVALENT

**THE GORMAN-RUPP COMPANY • MANSFIELD, OHIO**

GORMAN-RUPP OF CANADA LIMITED • ST. THOMAS, ONTARIO, CANADA

# Standard Models Cont'd

MODEL NUMBER	NOM. CAPACITY - SPEED				MAXIMUM				SHIPPING DATA	
	MAXIMUM		ALTERNATIVE		DIFFERENTIAL PRESSURE-PSI [BAR]			TEMP.	Weight	Volume
	GPM [LPM]	RPM 60 Hz [50 Hz]	GPM [LPM]	RPM 60 Hz [50 Hz]	BELOW 38 SSU [4 cSt]	38 TO 100 SSU [21 cSt]	100 TO 250,000 SSU [55,000 cSt]	°F [°C]		
GMS 2 JJ 3-B ● GMS 2 JJ 4-B ■	47 [177]	960 [960]	42 [133]	870 [725]	50 [3]	75 [5]	150 [10.3]	● 400 [205]	83	2.9
GMS 2-1/2 JJ 3-B ● GMS 2-1/2 JJ 4-B ■									83 [37,6]	2.9
GMS 3 JJ 3-B ● GMS 3 JJ 4-B ■									83 [37,6]	2.9
GMS 2 JL 3-B ● GMS 2 JL 4-B ■	64 [243]	960 [960]	58 [183]	870 [725]	50 [3]	75 [5]	150 [10.3]	● 400 [205]	83	2.9
GMS 2-1/2 JL 3-B ● GMS 2-1/2 JL 4-B ■									83 [37,6]	2.9
GMS 3 JL 3-B ● GMS 3 JL 4-B ■									83 [37,6]	2.9
GMS 2 JP 3-B ● GMS 2 JP 4-B ■	89 [338]	960 [960]	81 [256]	870 [725]	50 [3]	75 [5]	150 [10.3]	● 400 [205]	83	2.9
GMS 2-1/2 JP 3-B ● GMS 2-1/2 JP 4-B ■									83 [37,6]	2.9
GMS 3 JP 3-B ● GMS 3 JP 4-B ■									83 [37,6]	2.9
GMS 1-1/2 NK 3-B ● GMS 1-1/2 NK 4-B ■	90 [283]	960 [960]	60 [189]	870 [725]	50 [3]	75 [5]	150 [10.3]	■ 450 [230]	109	2.9
GMS 2 NK 3-B ● GMS 2 NK 4-B ■									109 [49]	2.9
GMS 2-1/2 NK 3-B ● GMS 2-1/2 NK 4-B ■									109 [49]	2.9
GMS 3 NK 3-B ● GMS 3 NK 4-B ■	120 [378]	960 [960]	80 [252]	870 [725]	50 [3]	75 [5]	150 [10.3]	■ 450 [230]	109	2.9
GMS 2 NM 3-B ● GMS 2 NM 4-B ■									109 [49]	2.9
GMS 2-1/2 NM 3-B ● GMS 2-1/2 NM 4-B ■									109 [49]	2.9
GMS 3 NM 3-B ● GMS 3 NM 4-B ■	150 [473]	960 [960]	99 [312]	870 [725]	50 [3]	75 [5]	150 [10.3]	■ 450 [230]	109	2.9
GMS 2 NP 3-B ● GMS 2 NP 4-B ■									109 [49]	2.9
GMS 2-1/2 NP 3-B ● GMS 2-1/2 NP 4-B ■									109 [49]	2.9
GMS 3 NP 3-B ● GMS 3 NP 4-B ■									109	2.9

STANDARD MODELS CONT.

- MECHANICAL SEAL
- PACKING/LIPSEAL

NOTE: RECOMMENDED PORT SIZES ARE SHOWN IN **BOLDFACE**. EXAMPLE: **GMS 2GJ 3-B**

**THE GORMAN-RUPP COMPANY • MANSFIELD, OHIO**  
 GORMAN-RUPP OF CANADA LIMITED • ST. THOMAS, ONTARIO, CANADA

MODEL NUMBER	NOM. CAPACITY - SPEED				MAXIMUM				SHIPPING DATA							
	MAXIMUM		ALTERNATIVE		DIFFERENTIAL PRESSURE - PSI [BAR]			TEMP.	Weight LBS [KG]	Volume CU. FT.						
	GPM [LPM]	RPM 60 Hz [50 Hz]	GPM [LPM]	RPM 60 Hz [50 Hz]	BELOW 38 SSU [4 cSt]	38 TO 100 SSU [21 cSt]	100 TO 250,000 SSU [55,000 cSt]	°F [°C]								
GMS 2 RM 3-B ● GMS 2 RM 4-B ■	153 [542]	640 [600]	115 [362]	480 [400]				● 400 [205]	233 [106]	10.7						
GMS 2-1/2 RM 3-B ● † GMS 2-1/2 RM 4-B ■ †									233 [106]	10.7						
<b>GMS 3 RM 3-B ● †</b> <b>GMS 3 RM 4-B ■ †</b>									233 [106]	10.7						
GMS 4 RM 3-B ● † GMS 4 RM 4-B ■ †									233 [106]	10.7						
GMS 2-1/2 RP 3-B ● † GMS 2-1/2 RP 4-B ■ †									233 [106]	10.7						
<b>GMS 3 RP 3-B ● †</b> <b>GMS 3 RP 4-B ■ †</b>	190 [678]	640 [600]	143 [451]		50 [3]	75 [5]	150 [10.3]	● 400 [205]	233 [106]	10.7						
GMS 4 RP 3-B ● † GMS 4 RP 4-B ■ †	233 [106]								10.7							
GMS 2-1/2 RR 3-B ● † GMS 2-1/2 RR 4-B ■ †	228 [804]								170 [536]					■ 450 [230]	233 [106]	10.7
GMS 3 RR 3-B ● † GMS 3 RR 4-B ■ †															233 [106]	10.7
<b>GMS 4 RR 3-B ● †</b> <b>GMS 4 RR 4-B ■ †</b>															233 [106]	10.7
GMS 3 RS 3-B ● † GMS 3 RS 4-B ■ †	265 [930]	196 [618]						233 [106]	10.7							
<b>GMS 4 RS 3-B ● †</b> <b>GMS 4 RS 4-B ■ †</b>								233 [106]	10.7							

NOTE: RECOMMENDED SIZES ARE SHOWN IN **BOLDFACE**. EXAMPLE: **GMS 2GJ 3-B**

† PORTS ARE COMPATIBLE WITH 125# ANSI CAST IRON FLANGES. ALL OTHER PORTS ARE TAPPED NPT FOR ANSI PIPE. OPTIONAL [DIN] FLANGES OR TAPPED [BSP] PORTS AVAILABLE FOR EXPORT MARKET.

**THE GORMAN-RUPP COMPANY • MANSFIELD, OHIO**  
GORMAN-RUPP OF CANADA LIMITED • ST. THOMAS, ONTARIO, CANADA

# Basic Pump Dimensions



CAD FILE NO.: 16530

MODEL NUMBERS	PUMP DIMENSIONS - INCHES [MILLIMETERS]															
	A	B	C	D	E	F	G	H	J	K	L	M	N	P	Q	
GMS D	1"	2.50* [64]	4.00 [102]	3.50* [89]	1.62 [41]	1.62 [41]	.41 [10]	1.44 [36]	5.81 [148]	3.24 [82]	.89 [23]	3.99 [101]	4.97 [126]	.19 [5] x 1.00 [25]	.62 [16]	
		2.75† [70]		4.50 [114]												5.25 [133]
		3.19 [81]														
		4.00† [102]														
GMS G	1-1/2"	3.50* [89]	4.88 [124]	3.50* [89]	1.62 [41]	1.62 [41]	.41 [10]	1.64 [42]	5.96 [151]	3.85 [98]	.76 [19]	4.14 [105]	5.70 [145]	.19 [5] x 1.25 [32]	.75 [19]	
		3.75† [95]		4.50 [114]												5.25 [133]
	2"	4.00 [102]	6.25 [159]													
		4.00† [102]														
GMS J	2"	4.50* [114]	6.88 [175]	5.25* [133]	2.88 [73]	3.00 [76]	.44 [11]	2.50 [64]	9.91 [252]	5.71 [145]	1.18 [30]	7.31 [186]	8.50 [216]	.25 [6] x 2.00 [51]	1.00 [25]	
		5.00† [127]		6.25 [159]												7.00 [178]
	6.00† [152]	7.00 [178]		8.00 [203]												
	6.31† [160]	8.00 [203]														
GMS N	1-1/2"	5.12* [130]	8.00 [203]	4.50 [114]	2.88 [73]	4.25 [108]	.44 [11]	2.50 [64]	9.20 [234]	6.42 [163]	1.12 [28]	6.12 [155]	7.59 [193]	.25 [6] x 2.00 [51]	1.25 [32]	
				5.25* [133]												6.25 [159]
	7.19† [183]			7.00 [178]												8.00 [203]
				8.00 [203]												
GMS R	2"	8.50* [216]	10.25 [260]	7.00* [178]	3.75 [95]	5.75 [146]	.53 [13]	3.03 [77]	12.50 [318]	8.43 [214]	1.38 [35]	8.35 [212]	11.31 [287]	.38 [10] x 2.25 [57]	1.50 [38]	
				7.00* [178]												7.00* [178]
	7.19† [183]			7.00* [178]												7.00* [178]
				7.00* [178]												7.00* [178]

\* STANDARD DIMENSION

† 180° HOUSING

‡ PORTS ARE COMPATIBLE WITH 125# OR 250# ANSICAST IRON FLANGES. ALL OTHER PORTS ARE TAPPED NPT FOR ANSIPPIPE. OPTIONAL (DIN) FLANGES OR TAPPED (BSP) PORTS AVAILABLE FOR EXPORT MARKET.

**THE GORMAN-RUPP COMPANY • MANSFIELD, OHIO**  
**GORMAN-RUPP OF CANADA LIMITED • ST. THOMAS, ONTARIO, CANADA**



## DIRECT FLEX DRIVE OPTION DIMENSIONS



CAD FILE NO.: 16567

PUMP MODEL	PUMP DIMENSIONS - INCHES[MILLIMETERS]														
	A	B	MOTOR FRAME	C	D	E	F	G	H	J	K	L	M	N	
GMS D	1"	2.50*	56 (H)	2.00	3.50*	4.44	8.88	10.14	.56	20.04	19.25	25.25	3.00	4.97	
		[64]	143T/145T	[51]	[89]	[113]	[228]	[258]		[509]	[489]	[841]	[78]		
		2.75 †	182T/184T	4.00	4.50	7.75	15.50	17.50		26.41	23.50	33.50	5.00		[126]
		[70]	213T/215T	[102]	[114]	[197]	[394]	[445]		[671]	[597]	[851]	[127]		
GMS G	1- 1/2"	3.50*	56 (H)	2.00	3.50*	4.44	8.88	10.14	.56	20.20	19.25	25.25	3.00	5.71	
		[89]	143T/145T	[51]	[89]	[113]	[228]	[258]		[513]	[489]	[841]	[76]		
	2"	3.75 †	182T/184T	4.00	4.50	7.75	15.50	17.50	.56	26.57	23.50	33.50	5.00	[145]	
		[95]	213T/215T	[102]	[114]	[197]	[394]	[445]		[675]	[597]	[851]	[127]		
GMS J	2"	4.00 †	182T/184T	4.00	4.50	9.50	19.00	21.00	.69	36.16	35.50	45.50	5.00	8.49	
		[102]	213T/215T		[114]										[133]
	2- 1/2"	4.00 †	254T/256T	5.25*	9.50	19.00	21.00	.69	36.16	35.50	45.50	5.00	8.49		
		[102]	284T/286T	[133]	[241]	[483]	[533]	[18]	[918]	[902]	[1156]	[127]	[216]		
GMS N	1- 1/2"	4.50*	182T/184T	4.00	4.50	9.50	19.00	21.00	.69	35.44	35.50	45.50	5.00	7.59	
		[114]	213T/215T		[114]										[133]
	2"	5.00 †	254T/256T	5.25*	9.50	19.00	21.00	.69	35.44	35.50	45.50	5.00	7.59		
		[127]	284T/286T	[133]	[241]	[483]	[533]	[18]	[900]	[902]	[1158]	[127]	[193]		
2- 1/2"	6.00 †	324T/326T	8.00	9.50	19.00	21.00	.69	35.44	35.50	45.50	5.00	8.70			
	[152]		[203]	[241]	[483]	[533]	[18]	[900]	[902]	[1158]	[127]	[221]			
3"	6.31 †			8.00	9.50	19.00	21.00	.69	35.44	35.50	45.50	5.00	8.70		
	[160]			[203]	[241]	[483]	[533]	[18]	[900]	[902]	[1158]	[127]	*		

\* STANDARD DIMENSION

† 180° HOUSING

┆ PORTS ARE COMPATIBLE WITH 125# OR 250# ANSICAST IRON FLANGES. ALL OTHER PORTS ARE TAPPED NPT FOR ANSIPPIPE. OPTIONAL (DIN) FLANGES OR TAPPED (BSP) PORTS AVAILABLE FOR EXPORT MARKET.

## DIRECT FLEX DRIVE OPTIONS

Drive Assembly Number Includes Base, Coupling & Guard, But **Not** the Motor



CAD FILE NO.: 16567

PUMP MODEL NUMBER	60 HZ. RPM	FRAME	MTG. FT. OPTION REQ.	DRIVE ASSY NO.
<b>GMS D</b>	1750 1150 850	56/56H	STD	90251-082
		143T/145T	STD	90251-084
		182T/184T	80F	90251-090
		213T/215T	80J	90251-094
<b>GMS G</b>	1750 1150 850	56/56H	STD	90251-160
		143T/145T	STD	90251-162
		184	80F	90221-156
		182T/184T	80F	90251-168
		213T/215T	80J	90251-176
<b>GMS J</b>	850	254T	80P	90251-180
		182T/184T	80F	90251-310
		213T/215T	STD	90251-318
		254T/256T	80P	90251-330
<b>GMS N</b>	850	284T/286T	80S	90251-338
		254T/256T	80P	90251-394
		284T/286T	80S	90251-402
		324T/326T	80V	90251-410

NOTE: CONSULT FACTORY FOR OPTIONS NOT SHOWN.



## GRR REDUCER C-FLANGE FLEX DRIVE OPTION DIMENSIONS (56C - 215TC Frame Size Range)



CAD FILE NO.: 16573

PUMP MODEL	PUMP DIMENSIONS																
	A	B	MOTOR FRAME	C	D	E	F	G	H	J	K	L	M	N			
GMS D	1"	2.50 * [64]	56C	2.00 [51]	3.50 * [89]	6.50 [165]	13.00 [330]	15.00 [381]	.56 [14]	19.98 [507]	25.50 [648]	31.50 [800]	3.00 [76]	4.98 [126]			
		2.75 † [70]	184C			7.31 [186]	14.62 [371]	16.62 [422]		26.68 [678]	37.25 [946]	43.25 [1098]					
		3.19 † [61]	143TC/145TC														
		4.00 † [102]	182TC/184TC														
			213TC/215TC														
GMS G	1-1/2"	3.50 * [89]	56C	2.00 [51]	3.50 * [89]	6.50 [165]	13.00 [330]	15.00 [381]	.58 [14]	20.11 [511]	25.50 [648]	31.50 [800]	3.00 [76]	5.72 [145]			
		3.75 † [95]	184C			7.31 [186]	14.62 [371]	16.62 [422]		26.81 [681]	37.25 [946]	43.25 [1098]					
	4.00 † [102]	143TC/145TC	4.50 [114]														
	4.00 † [102]	182TC/184TC	5.25 [133]														
			213TC/215TC														
GMS J	2"	4.50 * [114]	182TC/184TC	2.00 [51]	4.50 [114]	7.31 [186]	14.62 [371]	16.62 [422]	.56 [14]	30.20 [767]	32.00 [813]	38.00 [965]	3.00 [76]	8.50 [216]			
	2-1/2"	5.00 † [127]															
		6.00 † [152]									213TC/215TC	5.25 * [133]					
	3"	6.31 † [160]															
GMS N	1-1/2"		182TC/184TC	2.00 [51]	4.50 [114]	7.31 [186]	14.62 [371]	16.62 [422]	.56 [14]	* 29.48 [749]			3.00 [76]	7.59 [193]			
	2"	5.12 * [130]															
	2-1/2"	7.19 † [183]								213TC/215TC	5.25 * [133]						
	3"																

\* STANDARD DIMENSION

† 180° HOUSING

‡ PORTS ARE COMPATIBLE WITH 125# OR 250# ANSI/AST IRON FLANGES. ALL OTHER PORTS ARE TAPPED NPT FOR ANSI PIPE. OPTIONAL (DIN) FLANGES OR TAPPED (BSP) PORTS AVAILABLE FOR EXPORT MARKET.





## GRR REDUCER C-FLANGE FLEX DRIVE OPTION DIMENSIONS (213TC - 326TC Frame Size Range)

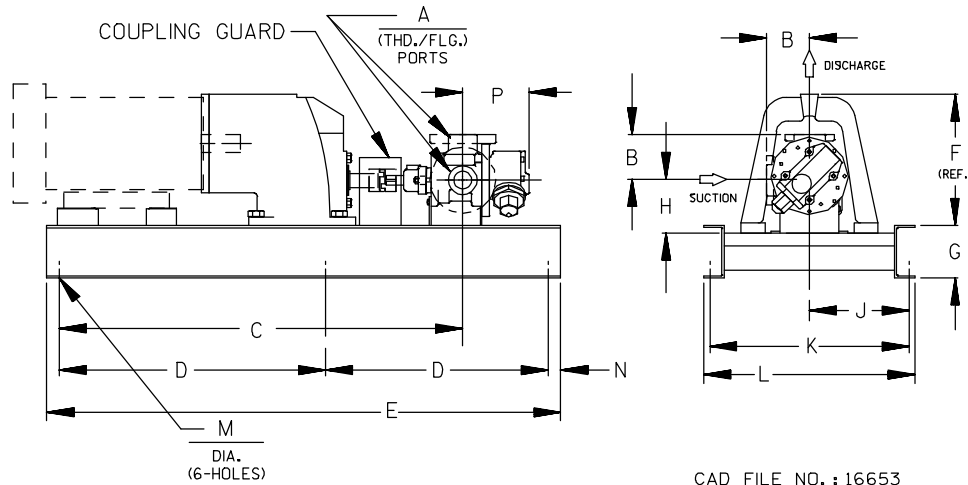

CAD FILE NO. : 16653

PUMP MODEL	PUMP DIMENSIONS														
	A	B	MOTOR FRAME	C	D	E	F	G	H	J	K	L	M	N	P
GMS J	2"	4.50 * [114]	213TC/215TC	41.57 [1056]	23.00 [584]	56.00 [1422]	12.14 [308]								
	2 1/2"	5.00 † [127]	254TC/256TC	42.03 [1068]				8.00 [203]	6.25 [159]	10.12 [257]	20.25 [514]	22.50 [572]	.69 [18]	5.00 [127]	8.49 [216]
		6.00 † [152]	254TC/256TC	44.76 [1137]	24.12 [613]	58.25 [1480]									
	3"	6.31 † [160]	284TC/286TC	46.98 [1183]	25.75 [654]	61.50 [1562]	14.91 [378]								
GMS N	1 1/2"		213TC/215TC	41.98 [1066]											
	2"	5.12 * [130]	213TC/215TC	40.85 [1038]	23.00 [584]	56.00 [1422]	12.14 [308]								
				254TC/256TC	42.42 [1077]				8.00 [152]	6.25 [159]	10.12 [257]	20.25 [514]	22.50 [572]	.69 [18]	5.00 [127]
	2 1/2"	7.19 † [183]	254TC/256TC	45.15 [1147]	24.12 [613]	58.25 [1480]									8.70 [221]
3"		284TC/286TC	47.37 [1203]	25.75 [654]	61.50 [1562]	14.91 [379]								*	
GMS R	2"		184TC	38.50 [978]	22.62 [575]	55.25 [1403]	10.80 [274]								
	2 1/2"	6.50 * [165]	213TC/215TC												
				213TC/215TC	43.80 [1112]	25.28 [642]	60.56 [1538]	12.26 [311]	8.00 [203]	7.00 [178]	10.38 [264]	20.75 [527]	23.00 [584]	.69 [18]	5.00 [127]
	3"	7.19 † [183]	254TC/256TC												
4"		254TC/256TC	48.75 [1238]	27.75 [705]	65.50 [1664]	16.04 [407]									
		284TC/286TC													

\* STANDARD DIMENSION

† 180° HOUSING

‡ PORTS ARE COMPATIBLE WITH 125\* OR 250\* ANSI/AST IRON FLANGES. ALL OTHER PORTS ARE TAPPED NPT FOR ANSI PIPE. OPTIONAL (DIN) FLANGES OR TAPPED (BSP) PORTS AVAILABLE FOR EXPORT MARKET.

**CROSS REFERENCE OF MOTOR FRAMES TO GEARBOX RATIOS:**

- Ⓐ 2:1, 3.15:1 (15 hp Only), 2.5:1
- Ⓑ 3.15:1 (20 hp Only), 4:1, 5:1
- Ⓒ 2.5:1, 4:1
- Ⓓ 3.15:1, 5:1

**REFERENCE: PUMP FOOT BRACKET OPTIONS**

MOTOR FRAME	CENTER HEIGHT	PUMP OPTION
213TC thru 286TC	6.25"	80P ("J" & "N" Size Only)
182TC thru 326TC	7.00"	STD ("R" Size Only)



# GMS

SEC. 525

PAGE 19  
January 2010

## GRR REDUCER C-FLANGE FLEX DRIVE OPTIONS

(Drive Assembly Number Includes Base, Coupling, Guard and Gear Reducer, But **NOT** the Motor)



CAD FILE NO.: 16573

PUMP MODEL	RPM @ 1750	RPM @ 1150	REDUCER ①		FRAME	MTG.FT. OPTION REQ.	DRIVE ASSY NO.		
			MAX HP @ 1750	MAX HP @ 1150					
GMS D	875	575	2.00:1	5.65	3.73	56C	STD	90253-510	
				11.70	7.72	143TC/145TC	STD	90253-516	
				11.70	7.72	182C/184C	80F	90253-519	
				13.01	8.59	182TC/184TC	80F	90253-526	
	580	383	3.00:1	3.76	2.48	56C	STD	90253-530	
				8.10	5.35	143TC/145TC	STD	90253-533	
				8.10	5.35	182C/184C	80F	90253-539	
	440	288	4.00:1	10.62	7.01	182TC/184TC	80F	90253-546	
				2.82	1.86	56C	STD	90253-550	
				5.90	3.89	143TC/145TC	STD	90253-553	
	350	230	5.00:1	5.90	3.89	182C/184C	80F	90253-562	
				7.24	4.78	182TC/184TC	80F	90253-566	
				2.26	1.49	56C	STD	90253-570	
				5.20	3.43	143TC/145TC	STD	90253-573	
	GMS G	875	575	2.00:1	5.20	3.43	182C/182C	80F	90253-582
					5.98	3.95	182TC/184TC	80F	90253-586
5.65					3.73	56C	STD	90253-610	
11.70					7.72	143TC/145TC	STD	90253-616	
11.70					7.72	182C/184C	80F	90253-624	
580		383	3.00:1	13.01	8.59	182TC/184TC	80F	90253-626	
				13.01	8.59	213TC/213TC	80J	90253-628	
				3.76	2.48	56C	STD	90253-630	
				8.10	5.35	143TC/145TC	STD	90253-639	
440		288	4.00:1	8.10	5.35	182C/184C	80F	90223-639	
	10.62			7.01	182TC/184TC	80F	90253-646		
	10.62			7.01	213TC/215TC	80J	90253-648		
	2.82			1.86	56C	STD	90253-660		
350	230	5.00:1	5.90	3.89	143TC/145TC	STD	90253-663		
			5.90	3.89	182C/184C	80F	90253-672		
			7.24	4.78	182TC/184TC	80F	90253-675		
			7.24	4.78	213TC	80J	90253-677		
			2.26	1.49	56C	STD	90253-690		
350	230	5.00:1	5.20	3.43	143TC/145TC	STD	90253-693		
			5.20	3.43	182C/184C	80F	90253-702		
			5.89	3.95	182TC/184TC	80F	90253-705		
			5.89	3.95	213TC	80J	90253-707		

(CONT'D)

① Listed reducer horsepower rated for Standard Service (8-10 hrs/day). For Light Service (3-5 hrs/day) multiply maximum rated horsepower by 1.1. For Heavy Service (16-24 hrs/day) multiply maximum rated horsepower by 0.9.

NOTE: CONSULT FACTORY FOR OPTIONS NOT SHOWN.



# GMS

## GRR REDUCER C-FLANGE FLEX DRIVE OPTIONS

(Drive Assembly Number Includes Base, Coupling, Guard and Gear Reducer, But **NOT** the Motor)

PUMP MODEL	RPM @ 1750	RPM @ 1150	REDUCER <sup>①</sup>		FRAME	MTG.FT. OPTION REQ.	DRIVE ASSY NO.	
			MAX HP @ 1750	MAX HP @ 1150				
GMS J	875	575	2.00:1	13.01	8.59	182TC/184TC	80F	90253-722
				13.01	8.59	213TC/215TC	STD	90253-724
				36.29	23.95	254TC/256TC	80P	90253-728
				36.29	23.95	284TC/286TC	80P	90253-732
	580	383	3.00:1	10.62	7.01	182TC/184TC	80F	90253-735
				10.62	7.01	213TC/215TC	80J	90253-741
	550	365	3.15:1	25.76	17.00	254TC/256TC	80P	90253-743
				25.76	17.00	284TC	80P	90253-746
				42.96	28.35	286TC	80P	90253-747
	440	288	4.00:1	7.24	4.78	182TC/184TC	80F	90253-750
				7.24	4.78	213TC	80J	90253-754
	350	230	5.00:1	5.98	3.95	182TC/184TC	80F	90253-767
				5.98	3.95	213TC	STD	90253-769
				16.01	10.57	215TC	80P	90253-774
				30.49	20.12	254TC/256TC	80J	90253-778
	GMS N	875	575	2.00:1	13.01	8.59	213TC/215TC	STD
36.29					23.95	254TC/256TC	80P	90253-801
36.29					23.95	284TC/286TC	80P	90253-805
580		383	3.00:1	10.62	7.01	213TC/215TC	STD	90253-814
				25.76	17.00	254TC/256TC	80P	90253-819
550		365	3.15:1	42.96	28.35	284TC/286TC	80P	90253-820
				7.24	4.78	213TC	STD	90253-827
350		230	5.00:1	5.98	3.95	213TC	STD	90253-842
				16.01	10.57	215TC	80P	90253-845
				30.49	20.12	254TC/256TC	80P	90253-847
GMS R	640	417	2.76:1	80.20	52.93	324TC	STD	90253-874
				80.20	52.93	364TC	STD	90253-878
	555	365	3.15:1	10.10	6.66	213TC/215TC	STD	90253-881
				25.76	17.00	254TC/256TC	STD	90253-886
				42.96	28.35	284TC/286TC	STD	90253-891
	520	340	3.38:1	66.20	43.69	324TC	STD	90253-896
				66.20	43.69	326TC	STD	90253-898
	440	288	4.00:1	9.42	6.22	184TC	STD	90253-901
				20.00	13.20	213TC/215TC	STD	90253-904
				38.16	25.18	254TC/256TC	STD	90253-909
				38.16	25.18	284TC	STD	90253-913
	420	278	4.13:1	40.40	26.40	286TC	STD	90253-916
				54.40	35.90	324TC	STD	90253-918
	350	230	5.00:1	6.10	4.03	184TC	STD	90253-921
				16.01	10.57	213TC/215TC	STD	90253-924
30.49				20.12	254TC/256TC	STD	90253-929	
30.49				20.12	284TC/286TC	STD	90253-933	

① Listed reducer horsepower rated for Standard Service (8-10 hrs/day). For Light Service (3-5 hrs/day) multiply maximum rated horsepower by 1.1. For Heavy Service (16-24 hrs/day) multiply maximum rated horsepower by 0.9.

NOTE: CONSULT FACTORY FOR OPTIONS NOT SHOWN.

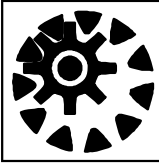

# PERFORMANCE CURVES

## SPEED VS. CAPACITY/HORSEPOWER

SEC. 500

Page 116

RR Hydraulic Size

January 2010

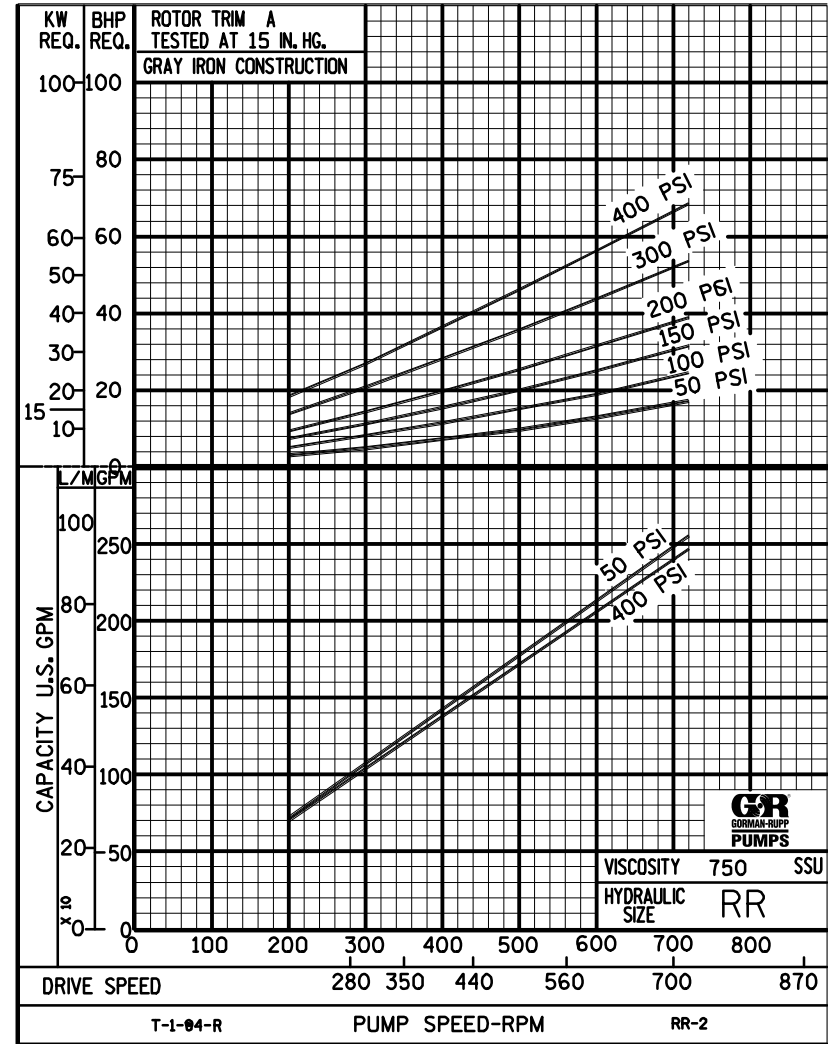
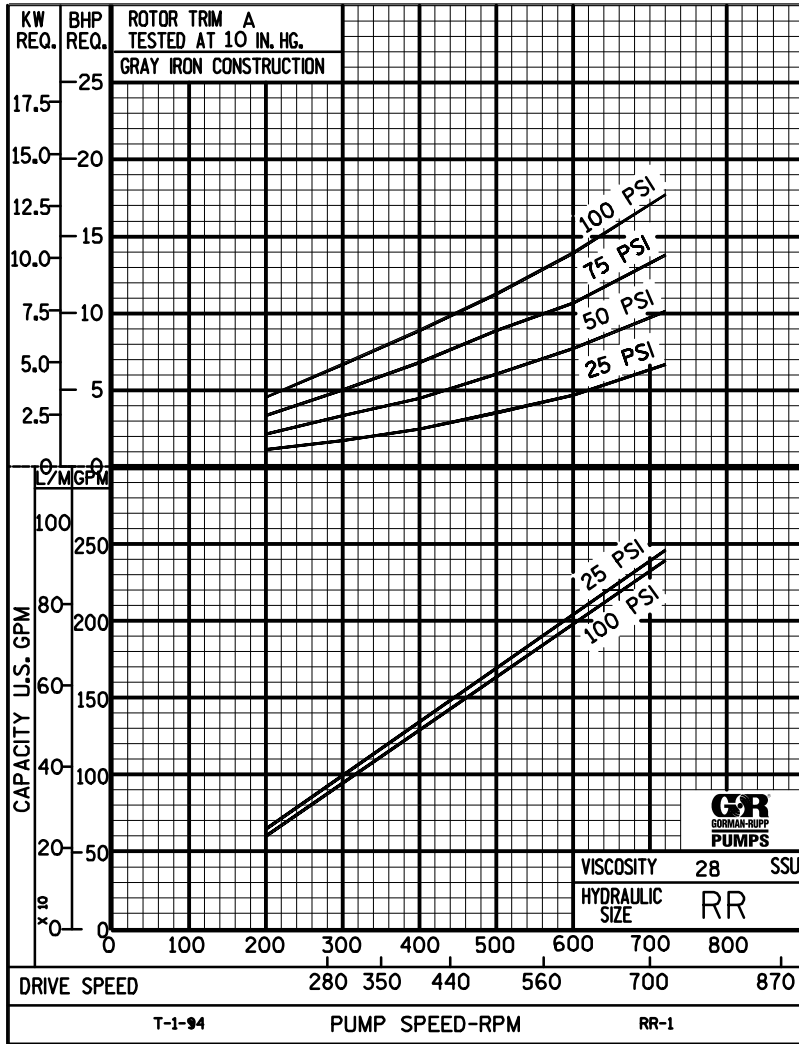

THE GORMAN-RUPP COMPANY • MANSFIELD, OHIO  
 GORMAN-RUPP OF CANADA LIMITED • ST. THOMAS, ONTARIO, CANADA

Printed in U.S.A.

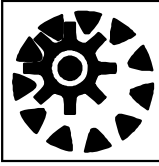

# PERFORMANCE CURVES

## SPEED VS. CAPACITY/HORSEPOWER

**RR** Hydraulic Size

SEC. 500

Page 117

January 2010

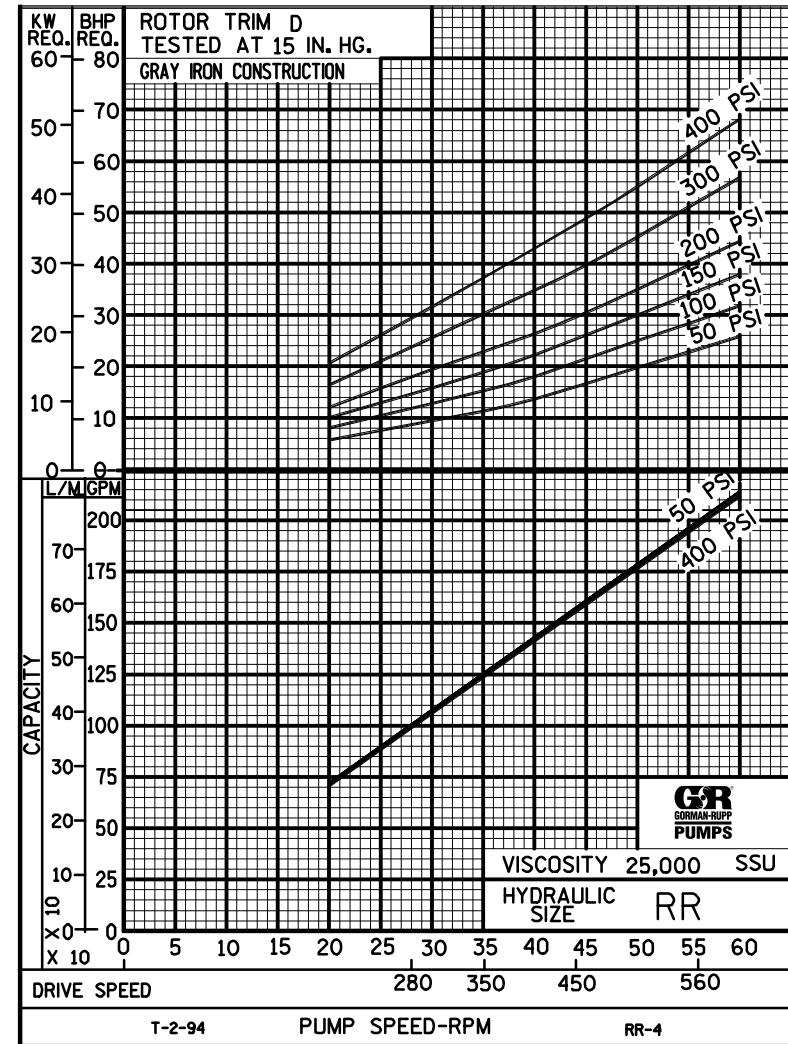
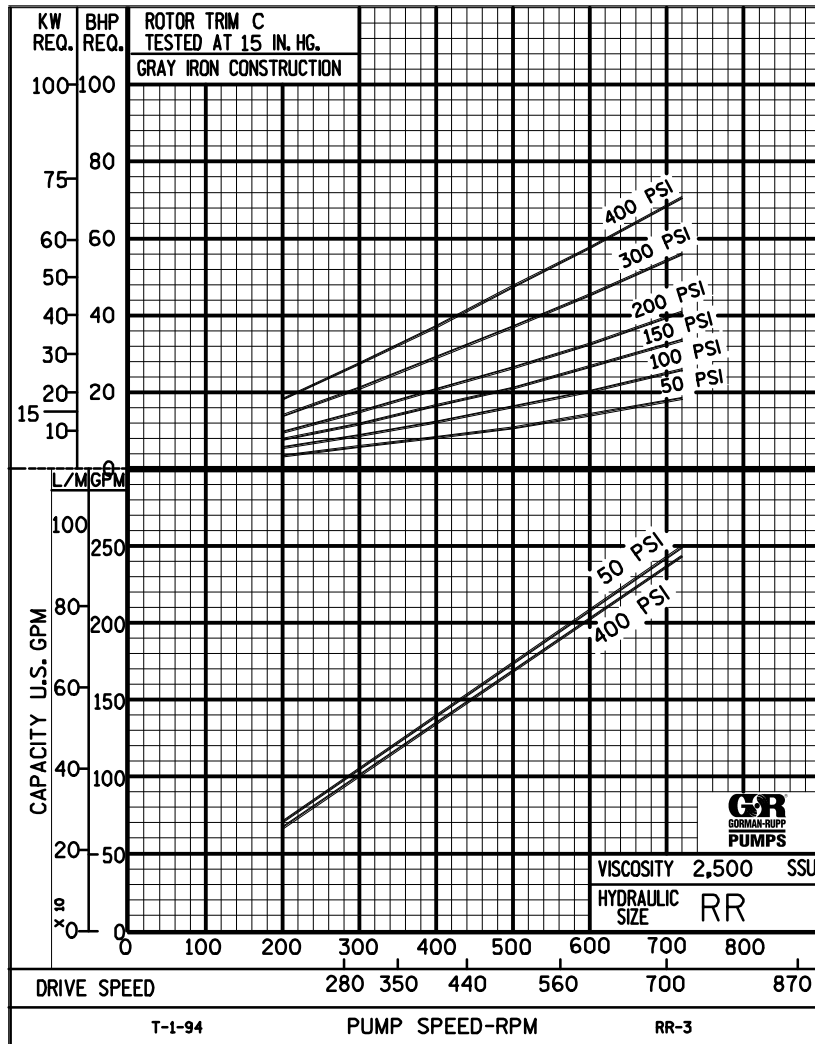

**THE GORMAN-RUPP COMPANY • MANSFIELD, OHIO**  
GORMAN-RUPP OF CANADA LIMITED • ST. THOMAS, ONTARIO, CANADA

Printed in U.S.A.



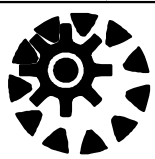

# RR

## PUMP HYDRAULIC SIZE CHART

SEC. 500

Page 119  
January 2010

228 GPM  
640 RPM

NOMINAL		ROTOR TRIM	VISCOSITY (SSU)	N.I.P.R. (PSIA)	FRICTION PIPE LOSS (PSI/FT) <small>(Based on Sch 40 Steel Pipe)</small>					FULL BYPASS RELIEF VALVE PRESSURE (PSI)					CAPACITY (GPM) / H.P. REQUIRED									
CAP. GPM	SPEED RPM				PIPE DIAMETER					CRACKING PRESS. (PSI)					DIFFERENTIAL PRESSURE (PSI)									
					2"	2 1/2"	3"	4"	6"	LOW PRES R/V		HI PRES R/V			MEDIUM DUTY AND HEAVY DUTY				HEAVY DUTY ONLY					
228	640	STD	28	3.7	.37	.15	.05	.01	-	64	88	125	187		218	216	214	212						
			32		.39	.16	.05	.01	-						5.9	8.6	12	15						
			38	3.7	.41	.17	.06	.02	-	67	91	128	190		220	216	216	214	212					
			50		.45	.19	.06	.02	-						6.9	10	13	17	23					
			70	3.7	.49	.21	.07	.02	-	72	96	132	194	254	222	220	218	218	216	212				
			100		.54	.23	.08	.02	-						8.8	11	15	19	24	31				
			150	3.7	.60	.26	.09	.02	-	77	101	137	199	261	224	224	222	222	220	216	212	206		
			200		.64	.28	.10	.03	-						10	13	16	20	25	33	45	58		
			300	3.7	.72	.31	.11	.03	-	83	107	143	204	271	226	226	224	224	222	220	218	214		
			500		.83	.36	.13	.03	-						11	14	17	21	27	34	47	60		
		750	3.8	.95	.27	.11	.04	.01	87	112	147	209	279	228	228	226	226	224	224	222	220			
		1,000		.74	.36	.15	.05	.01						12	15	18	21	28	35	48	61			
		2,000	4.3	1.48	.73	.31	.10	.02	95	121	155	216	293	224	222	222	222	220	220	218	216			
		3,500		2.59	1.27	.53	.18	.04						14	17	21	23	30	36	50	63			
		5,000	4.7	3.71	1.82	.76	.26	.05	101	126	160	221	301	224	224	224	224	222	220	220	216			
		7,500		5.56	2.73	1.15	.39	.08						15	19	24	26	33	36	51	65			
		10,000	5.3	7.41	3.64	1.53	.52	.10	105	131	165	225	309	224	222	222	222	222	220	220	218			
		15,000		11.1	5.46	2.29	.77	.15						17	21	26	29	35	41	55	68			
		20,000	6.2	14.8	7.28	3.05	1.03	.20	108	135	169	228	315	224	224	222	222	222	222	220	220			
		25,000		18.5	9.10	3.82	1.29	.25						19	23	28	32	37	43	57	71			
50,000																								
75,000																								
100,000																								
150,000																								
200,000																								
250,000																								

(NOTE) For speeds not shown on the pump hydraulic charts, consult factory.





