

**MEDIUM DUTY STANDARD;
 D, G, J, N & R SIZE
 ROTARY GEAR PUMP**

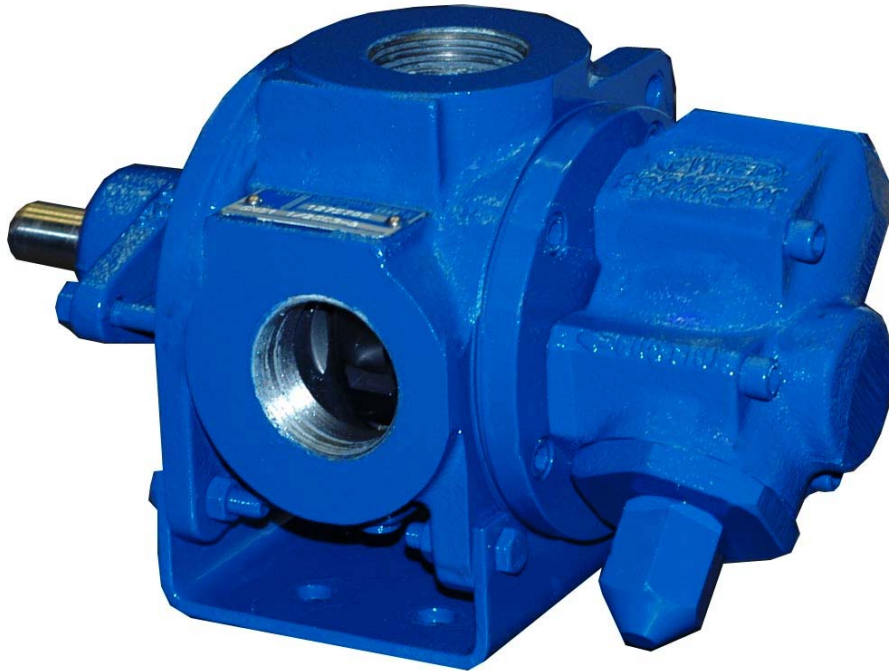

The GMS series is designed for applications in the operating ranges noted below. These units are available with head and backhead jackets (R size only) for temperature control, carbon graphite bushings for low viscosity liquids, silicon carbide bushings for wear resistance, and carbide, positive drive or packing seals for viscous sealing.

For continuous service, or for handling more viscous liquids, see the heavy duty GHS section.

For belt driven applications, select an extended shaft option and consult factory for availability of drive assembly. A pedestal bearing is required for belt driven applications.

FEATURES

- 150 PSI CAPABILITY
- SELF-CONTAINED, NO EXTERNAL BEARING REQUIRED (UNLESS BELT DRIVEN)
- HIGH STRENGTH, COMPUTER PROFILED GEARING FOR QUIET OPERATION
- THRUST CONTROLLED PUMP ELEMENTS
- EXCEPTIONAL SEAL VERSATILITY

OPERATING RANGE

- CAPACITY (GPM) : (3 TO 265)
 [LPM] : [11 TO 930]
- PRESSURE (PSI) : (0 TO 150)
 [BAR] : [0 TO 10.3]
- VISCOSITY (SSU) : (28 TO 250,000)
 [cSt] : [1 TO 55,000]
- TEMPERATURE (F) : (-60° TO 450°)
 [C] : [-51° TO 230°]

APPLICATIONS

- ★ BOOSTER SERVICE
- ★ CIRCULATING
- ★ FILTERING
- ★ LUBRICATING
- ★ TRANSFERRING

EXT.	ROTOR & IDLER	HOUSING PORTS	BUSHINGS	IDLER PIN	SHAFT	SHAFT SEALING		ROT.	INTERNAL RELIEF VALVE	
						MECH. SEAL ●	PACKING ■		MATERIAL	SETTING
CAST IRON	HIGH STRENGTH IRON	90° TAPPED	BRONZE	HARDENED STEEL		FLUORO ^① CARBON, NI-RESIST	PTFE, ^② GRAPHITE	C.W.	DUCTILE IRON	75 PSI [5 BAR]

Standard Models

G M S 1 DC 3 - B
 GEAR DUTY DESIGN PORT SIZE HYDRAULIC SEAL STYLE

MODEL NUMBER	NOM. CAPACITY - SPEED				MAXIMUM				SHIPPING DATA	
	MAXIMUM		ALTERNATIVE		DIFFERENTIAL PRESSURE-PSI [BAR]			TEMP.	Weight	Volume
	GPM	RPM	GPM	RPM	BELOW	38 TO	100 TO	°F	LBS	CU. FT.
	[LPM]	60 Hz [50 Hz]	[LPM]	60 Hz [50 Hz]	38 SSU [4 cSt]	100 SSU [21 cSt]	250,000 SSU [55,000 cSt]	[°C]	[KG]	FT.
GMS 1DC 3-B ● GMS 1DC 4-B ■	9 [28]		6 [19]					● 400 [205] ■ 450 [230]	19 [8,6]	0.6
GMS 1DE 3-B ● GMS 1DE 4-B ■	11 [35]		7 [22]						19 [8,6]	0.6
GMS 1-1/2 GC 3-B ● GMS 1-1/2 GC 4-B ■	16 [50]		10 [32]						32 [14,5]	2.9
GMS 2 GC 3-B ● GMS 2 GC 4-B ■									32 [14,5]	2.9
GMS 1-1/2 GF 3-B ● GMS 1-1/2 GF 4-B ■	23 [73]	1750 [1460]	15 [47]	1150 [960]					32 [14,5]	2.9
GMS 2 GF 3-B ● GMS 2 GF 4-B ■									32 [14,5]	2.9
GMS 1-1/2 GH 3-B ● GMS 1-1/2 GH 4-B ■	31 [98]		20 [63]		50 [3]	75 [5]	150 [10.3]		32 [14,5]	2.9
GMS 2 GH 3-B ● GMS 2 GH 4-B ■									32 [14,5]	2.9
GMS 1-1/2 GJ 3-B ● GMS 1-1/2 GJ 4-B ■	38 [120]		25 [79]						32 [14,5]	2.9
GMS 2 GJ 3-B ● GMS 2 GJ 4-B ■									32 [14,5]	2.9
GMS 2 JG 3-B ● GMS 2 JG 4-B ■									83 [37,6]	2.9
GMS 2-1/2 JG 3-B ● GMS 2-1/2 JG 4-B ■	33 [126]	960 [960]	30 [95]	870 [725]					83 [37,6]	2.9
GMS 3 JG 3-B ● GMS 3 JG 4-B ■									83 [37,6]	2.9

STANDARD MODELS CONT.

NOTE: RECOMMENDED PORT SIZES ARE SHOWN IN **BOLDFACE**. EXAMPLE: **GMS 2GJ3-B**

● MECHANICAL SEAL

■ PACKING/LIPSEAL

① DUPONT VITON® OR EQUIVALENT

② DUPONT TEFLON® OR EQUIVALENT

THE GORMAN-RUPP COMPANY • MANSFIELD, OHIO

GORMAN-RUPP OF CANADA LIMITED • ST. THOMAS, ONTARIO, CANADA

Standard Models Cont'd

MODEL NUMBER	NOM. CAPACITY - SPEED				MAXIMUM				SHIPPING DATA	
	MAXIMUM		ALTERNATIVE		DIFFERENTIAL PRESSURE-PSI [BAR]			TEMP.	Weight	Volume
	GPM [LPM]	RPM 60 Hz [50 Hz]	GPM [LPM]	RPM 60 Hz [50 Hz]	BELOW 38 SSU [4 cSt]	38 TO 100 SSU [21 cSt]	100 TO 250,000 SSU [55,000 cSt]	°F [°C]		
GMS 2 JJ 3-B ● GMS 2 JJ 4-B ■	47 [177]	960 [960]	42 [133]	870 [725]	50 [3]	75 [5]	150 [10.3]	● 400 [205]	83	2.9
GMS 2-1/2 JJ 3-B ● GMS 2-1/2 JJ 4-B ■									83 [37,6]	2.9
GMS 3 JJ 3-B ● GMS 3 JJ 4-B ■									83 [37,6]	2.9
GMS 2 JL 3-B ● GMS 2 JL 4-B ■	64 [243]	960 [960]	58 [183]	870 [725]	50 [3]	75 [5]	150 [10.3]	● 400 [205]	83	2.9
GMS 2-1/2 JL 3-B ● GMS 2-1/2 JL 4-B ■									83 [37,6]	2.9
GMS 3 JL 3-B ● GMS 3 JL 4-B ■									83 [37,6]	2.9
GMS 2 JP 3-B ● GMS 2 JP 4-B ■	89 [338]	960 [960]	81 [256]	870 [725]	50 [3]	75 [5]	150 [10.3]	● 400 [205]	83	2.9
GMS 2-1/2 JP 3-B ● GMS 2-1/2 JP 4-B ■									83 [37,6]	2.9
GMS 3 JP 3-B ● GMS 3 JP 4-B ■									83 [37,6]	2.9
GMS 1-1/2 NK 3-B ● GMS 1-1/2 NK 4-B ■	90 [283]	960 [960]	60 [189]	870 [725]	50 [3]	75 [5]	150 [10.3]	■ 450 [230]	109	2.9
GMS 2 NK 3-B ● GMS 2 NK 4-B ■									109 [49]	2.9
GMS 2-1/2 NK 3-B ● GMS 2-1/2 NK 4-B ■									109 [49]	2.9
GMS 3 NK 3-B ● GMS 3 NK 4-B ■	120 [378]	960 [960]	80 [252]	870 [725]	50 [3]	75 [5]	150 [10.3]	■ 450 [230]	109	2.9
GMS 2 NM 3-B ● GMS 2 NM 4-B ■									109 [49]	2.9
GMS 2-1/2 NM 3-B ● GMS 2-1/2 NM 4-B ■									109 [49]	2.9
GMS 3 NM 3-B ● GMS 3 NM 4-B ■	150 [473]	960 [960]	99 [312]	870 [725]	50 [3]	75 [5]	150 [10.3]	■ 450 [230]	109	2.9
GMS 2 NP 3-B ● GMS 2 NP 4-B ■									109 [49]	2.9
GMS 2-1/2 NP 3-B ● GMS 2-1/2 NP 4-B ■									109 [49]	2.9
GMS 3 NP 3-B ● GMS 3 NP 4-B ■									109	2.9

STANDARD MODELS CONT.

- MECHANICAL SEAL
- PACKING/LIPSEAL

NOTE: RECOMMENDED PORT SIZES ARE SHOWN IN **BOLDFACE**. EXAMPLE: **GMS 2GJ 3-B**

THE GORMAN-RUPP COMPANY • MANSFIELD, OHIO
 GORMAN-RUPP OF CANADA LIMITED • ST. THOMAS, ONTARIO, CANADA

MODEL NUMBER	NOM. CAPACITY - SPEED				MAXIMUM				SHIPPING DATA							
	MAXIMUM		ALTERNATIVE		DIFFERENTIAL PRESSURE - PSI [BAR]			TEMP.	Weight LBS [KG]	Volume CU. FT.						
	GPM [LPM]	RPM 60 Hz [50 Hz]	GPM [LPM]	RPM 60 Hz [50 Hz]	BELOW 38 SSU [4 cSt]	38 TO 100 SSU [21 cSt]	100 TO 250,000 SSU [55,000 cSt]	°F [°C]								
GMS 2 RM 3-B ● GMS 2 RM 4-B ■	153 [542]	640 [600]	115 [362]	480 [400]				● 400 [205]	233 [106]	10.7						
GMS 2-1/2 RM 3-B ● † GMS 2-1/2 RM 4-B ■ †									233 [106]	10.7						
GMS 3 RM 3-B ● † GMS 3 RM 4-B ■ †									233 [106]	10.7						
GMS 4 RM 3-B ● † GMS 4 RM 4-B ■ †									233 [106]	10.7						
GMS 2-1/2 RP 3-B ● † GMS 2-1/2 RP 4-B ■ †									233 [106]	10.7						
GMS 3 RP 3-B ● † GMS 3 RP 4-B ■ †	190 [678]	640 [600]	143 [451]		50 [3]	75 [5]	150 [10.3]	● 400 [205]	233 [106]	10.7						
GMS 4 RP 3-B ● † GMS 4 RP 4-B ■ †	233 [106]								10.7							
GMS 2-1/2 RR 3-B ● † GMS 2-1/2 RR 4-B ■ †	228 [804]								170 [536]					■ 450 [230]	233 [106]	10.7
GMS 3 RR 3-B ● † GMS 3 RR 4-B ■ †															233 [106]	10.7
GMS 4 RR 3-B ● † GMS 4 RR 4-B ■ †															233 [106]	10.7
GMS 3 RS 3-B ● † GMS 3 RS 4-B ■ †	265 [930]	196 [618]						233 [106]	10.7							
GMS 4 RS 3-B ● † GMS 4 RS 4-B ■ †								233 [106]	10.7							

NOTE: RECOMMENDED SIZES ARE SHOWN IN **BOLDFACE**. EXAMPLE: **GMS 2GJ 3-B**

† PORTS ARE COMPATIBLE WITH 125# ANSI CAST IRON FLANGES. ALL OTHER PORTS ARE TAPPED NPT FOR ANSI PIPE. OPTIONAL [DIN] FLANGES OR TAPPED [BSP] PORTS AVAILABLE FOR EXPORT MARKET.

THE GORMAN-RUPP COMPANY • MANSFIELD, OHIO
GORMAN-RUPP OF CANADA LIMITED • ST. THOMAS, ONTARIO, CANADA

Basic Pump Dimensions



CAD FILE NO.: 16530

MODEL NUMBERS	PUMP DIMENSIONS - INCHES [MILLIMETERS]															
	A	B	C	D	E	F	G	H	J	K	L	M	N	P	Q	
GMS D	1"	2.50* [64]	4.00 [102]	3.50* [89]	1.62 [41]	1.62 [41]	.41 [10]	1.44 [36]	5.81 [148]	3.24 [82]	.89 [23]	3.99 [101]	4.97 [126]	.19 [5] x 1.00 [25]	.62 [16]	
		2.75† [70]		4.50 [114]												5.25 [133]
		3.19 [81]		4.00† [102]												
GMS G	1-1/2"	3.50* [89]	4.88 [124]	3.50* [89]	1.62 [41]	1.62 [41]	.41 [10]	1.64 [42]	5.96 [151]	3.85 [98]	.76 [19]	4.14 [105]	5.70 [145]	.19 [5] x 1.25 [32]	.75 [19]	
		3.75† [95]		4.50 [114]												5.25 [133]
GMS J	2-1/2"	4.50* [114]	6.88 [175]	5.25* [133]	2.88 [73]	3.00 [76]	.44 [11]	2.50 [64]	9.91 [252]	5.71 [145]	1.18 [30]	7.31 [186]	8.50 [216]	.25 [6] x 2.00 [51]	1.00 [25]	
		5.00† [127]		6.25 [159]												7.00 [178]
		6.00† [152]		7.00 [178]												8.00 [203]
GMS N	2-1/2"	7.19† [183]	8.00 [203]	7.00 [178]	2.88 [73]	4.25 [108]	.44 [11]	2.50 [64]	9.20 [234]	6.42 [163]	1.12 [28]	6.12 [155]	8.70 [221]	.25 [6] x 2.00 [51]	1.25 [32]	
		5.12* [130]		5.25* [133]												7.59 [193]
		8.00 [203]		6.25 [159]												7.00 [178]
GMS R	3'	8.50* [216]	10.25 [260]	7.00* [178]	3.75 [95]	5.75 [146]	.53 [13]	3.03 [77]	12.50 [318]	8.43 [214]	1.38 [35]	8.35 [212]	11.31 [287]	.38 [10] x 2.25 [57]	1.50 [38]	
		7.19† [183]		7.00* [178]												8.00 [203]
		8.50* [216]		7.00* [178]												8.00 [203]
		7.19† [183]		7.00* [178]												8.00 [203]

* STANDARD DIMENSION

† 180° HOUSING

‡ PORTS ARE COMPATIBLE WITH 125* OR 250* ANSICAST IRON FLANGES. ALL OTHER PORTS ARE TAPPED NPT FOR ANSI PIPE. OPTIONAL (DIN) FLANGES OR TAPPED (BSP) PORTS AVAILABLE FOR EXPORT MARKET.

THE GORMAN-RUPP COMPANY • MANSFIELD, OHIO
GORMAN-RUPP OF CANADA LIMITED • ST. THOMAS, ONTARIO, CANADA



DIRECT FLEX DRIVE OPTION DIMENSIONS



CAD FILE NO.: 16567

PUMP MODEL	PUMP DIMENSIONS - INCHES[MILLIMETERS]													
	A	B	MOTOR FRAME	C	D	E	F	G	H	J	K	L	M	N
GMS D	1"	2.50*	56 (H)	2.00	3.50*	4.44	8.88	10.14		20.04	19.25	25.25	3.00	4.97
		[64]	143T/145T	[51]	[89]	[113]	[228]	[258]		[509]	[489]	[841]	[78]	
		2.75 †	182T/184T	4.00	4.50	7.75	15.50	17.50	.56	26.41	23.50	33.50	5.00	
		[70]	213T/215T	[102]	[114]	[197]	[394]	[445]	[14]	[671]	[597]	[851]	[127]	
		3.19 †		4.00 †		5.25								
		[81]		[82]		[133]								
		4.00 †												
		[82]												
GMS G	1- 1/2"	3.50*	56 (H)	2.00	3.50*	4.44	8.88	10.14		20.20	19.25	25.25	3.00	5.71
		[89]	143T/145T	[51]	[89]	[113]	[228]	[258]		[513]	[489]	[841]	[76]	
	3.75 †	182T/184T	4.00	4.50	7.75	15.50	17.50	.56	26.57	23.50	33.50	5.00		
	[95]	213T/215T	[102]	[114]	[197]	[394]	[445]	[14]	[675]	[597]	[851]	[127]		
		4.00												
		[102]												
		4.00 †												
		[102]												
GMS J	2"	4.50*	182T/184T	4.00	4.50									8.49
		[114]	213T/215T	[102]	[114]									
	5.00 †	254T/256T	4.00	5.25*	9.50	19.00	21.00	.69	36.16	35.50	45.50	5.00		
	[127]	284T/286T	[102]	[133]	[241]	[483]	[533]	[18]	[918]	[902]	[1156]	[127]		
		6.00 †												
		[152]												
		6.31 †												
		[160]												
GMS N	1- 1/2"		182T/184T		4.50									7.59
			213T/215T		[114]									
			254T/256T	4.00	5.25*	9.50	19.00	21.00	.69	35.44	35.50	45.50	5.00	
			284T/286T	[102]	[133]	[241]	[483]	[533]	[18]	[900]	[902]	[1158]	[127]	
			324T/326T		[159]	[241]	[483]	[533]	[18]	[900]	[902]	[1158]	[127]	
		5.12*												
		[130]												
		7.19 †												
		[183]												

* STANDARD DIMENSION

† 180° HOUSING

┆ PORTS ARE COMPATIBLE WITH 125# OR 250# ANSICAST IRON FLANGES. ALL OTHER PORTS ARE TAPPED NPT FOR ANSIPIPE. OPTIONAL (DIN) FLANGES OR TAPPED (BSP) PORTS AVAILABLE FOR EXPORT MARKET.

DIRECT FLEX DRIVE OPTIONS

Drive Assembly Number Includes Base, Coupling & Guard, But **Not** the Motor



CAD FILE NO.: 16567

PUMP MODEL NUMBER	60 HZ. RPM	FRAME	MTG. FT. OPTION REQ.	DRIVE ASSY NO.
GMS D	1750 1150 850	56/56H	STD	90251-082
		143T/145T	STD	90251-084
		182T/184T	80F	90251-090
		213T/215T	80J	90251-094
GMS G	1750 1150 850	56/56H	STD	90251-160
		143T/145T	STD	90251-162
		184	80F	90221-156
		182T/184T	80F	90251-168
		213T/215T	80J	90251-176
GMS J	850	254T	80P	90251-180
		182T/184T	80F	90251-310
		213T/215T	STD	90251-318
		254T/256T	80P	90251-330
GMS N	850	284T/286T	80S	90251-338
		254T/256T	80P	90251-394
		284T/286T	80S	90251-402
		324T/326T	80V	90251-410

NOTE: CONSULT FACTORY FOR OPTIONS NOT SHOWN.



GRR REDUCER C-FLANGE FLEX DRIVE OPTION DIMENSIONS (56C - 215TC Frame Size Range)



CAD FILE NO.: 16573

PUMP MODEL	PUMP DIMENSIONS															
	A	B	MOTOR FRAME	C	D	E	F	G	H	J	K	L	M	N		
GMS D	1"	2.50 * [64]	56C	2.00 [51]	3.50 * [89]	6.50 [165]	13.00 [330]	15.00 [381]	.56 [14]	19.98 [507]	25.50 [648]	31.50 [800]	3.00 [76]	4.98 [126]		
		2.75 † [70]	184C			7.31 [186]	14.62 [371]	16.62 [422]		26.68 [678]	37.25 [946]	43.25 [1098]				
		3.19 † [61]	143TC/145TC													
		4.00 † [102]	182TC/184TC													
			213TC/215TC													
GMS G	1-1/2"	3.50 * [89]	56C	2.00 [51]	3.50 * [89]	6.50 [165]	13.00 [330]	15.00 [381]	.58 [14]	20.11 [511]	25.50 [648]	31.50 [800]	3.00 [76]	5.72 [145]		
		3.75 † [95]	184C			7.31 [186]	14.62 [371]	16.62 [422]		26.81 [681]	37.25 [946]	43.25 [1098]				
	4.00 † [102]	143TC/145TC														
	4.00 † [102]	182TC/184TC	4.50 [114]													
			213TC/215TC		5.25 [133]											
GMS J	2"	4.50 * [114]	182TC/184TC	2.00 [51]	4.50 [114]	7.31 [186]	14.62 [371]	16.62 [422]	.56 [14]	30.20 [767]	32.00 [813]	38.00 [965]	3.00 [76]	8.50 [216]		
	2-1/2"	5.00 † [127]														
		6.00 † [152]	213TC/215TC								5.25 * [133]					
	3"	6.31 † [160]														
GMS N	1-1/2"		182TC/184TC	2.00 [51]	4.50 [114]	7.31 [186]	14.62 [371]	16.62 [422]	.56 [14]	* 29.48 [749]			3.00 [76]	7.59 [193]		
	2"	5.12 * [130]														
	2-1/2"	7.19 † [183]	213TC/215TC							5.25 * [133]						
	3"									30.59 [777]				*		

* STANDARD DIMENSION

† 180° HOUSING

‡ PORTS ARE COMPATIBLE WITH 125# OR 250# ANSI/AST IRON FLANGES. ALL OTHER PORTS ARE TAPPED NPT FOR ANSI PIPE. OPTIONAL (DIN) FLANGES OR TAPPED (BSP) PORTS AVAILABLE FOR EXPORT MARKET.



GRR REDUCER C-FLANGE FLEX DRIVE OPTION DIMENSIONS (213TC - 326TC Frame Size Range)

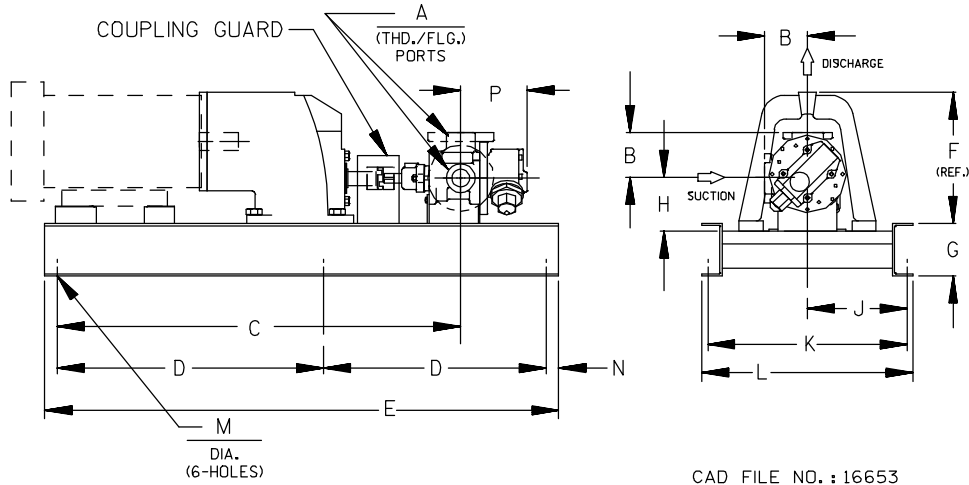

CAD FILE NO. : 16653

PUMP MODEL	PUMP DIMENSIONS														
	A	B	MOTOR FRAME	C	D	E	F	G	H	J	K	L	M	N	P
GMS J	2"	4.50 * [114]	213TC/215TC	41.57 [1056]	23.00 [584]	56.00 [1422]	12.14 [308]								
	2 1/2"	5.00 † [127]	254TC/256TC	42.03 [1068]				8.00 [203]	6.25 [159]	10.12 [257]	20.25 [514]	22.50 [572]	.69 [18]	5.00 [127]	8.49 [216]
		6.00 † [152]	254TC/256TC	44.76 [1137]	24.12 [613]	58.25 [1480]									
	3"	6.31 † [160]	284TC/286TC	46.98 [1183]	25.75 [654]	61.50 [1562]	14.91 [378]								
GMS N	1 1/2"		213TC/215TC	41.98 [1066]											
	2"	5.12 * [130]	213TC/215TC	40.85 [1038]	23.00 [584]	56.00 [1422]	12.14 [308]								
				254TC/256TC	42.42 [1077]				8.00 [152]	6.25 [159]	10.12 [257]	20.25 [514]	22.50 [572]	.69 [18]	5.00 [127]
	2 1/2"	7.19 † [183]	254TC/256TC	41.31 [1049]	24.12 [613]	58.25 [1480]									8.70 [221]
3"		284TC/286TC	45.15 [1147]	25.75 [654]	61.50 [1562]	14.91 [379]								*	
GMS R	2"		184TC	38.50 [978]	22.62 [575]	55.25 [11403]	10.80 [274]								
	2 1/2"	6.50 * [165]	213TC/215TC	43.80 [1112]	25.28 [642]	60.56 [1538]	12.26 [311]	8.00 [203]	7.00 [178]	10.38 [264]	20.75 [527]	23.00 [584]	.69 [18]	5.00 [127]	11.31 [287]
				213TC/215TC	43.80 [1112]	25.28 [642]	60.56 [1538]	12.26 [311]							
	3"	7.19 † [183]	254TC/256TC	48.75 [1238]	27.75 [705]	65.50 [1664]	16.04 [407]								
4"		284TC/286TC													

* STANDARD DIMENSION

† 180° HOUSING

‡ PORTS ARE COMPATIBLE WITH 125* OR 250* ANSI/AST IRON FLANGES. ALL OTHER PORTS ARE TAPPED NPT FOR ANSI PIPE. OPTIONAL (DIN) FLANGES OR TAPPED (BSP) PORTS AVAILABLE FOR EXPORT MARKET.

CROSS REFERENCE OF MOTOR FRAMES TO GEARBOX RATIOS:

- Ⓐ 2:1, 3.15:1 (15 hp Only), 2.5:1
- Ⓑ 3.15:1 (20 hp Only), 4:1, 5:1
- Ⓒ 2.5:1, 4:1
- Ⓓ 3.15:1, 5:1

REFERENCE: PUMP FOOT BRACKET OPTIONS

MOTOR FRAME	CENTER HEIGHT	PUMP OPTION
213TC thru 286TC	6.25"	80P ("J" & "N" Size Only)
182TC thru 326TC	7.00"	STD ("R" Size Only)



GMS

SEC. 525

PAGE 19
January 2010

GRR REDUCER C-FLANGE FLEX DRIVE OPTIONS

(Drive Assembly Number Includes Base, Coupling, Guard and Gear Reducer, But **NOT** the Motor)



CAD FILE NO.: 16573

PUMP MODEL	RPM @ 1750	RPM @ 1150	REDUCER ①		FRAME	MTG.FT. OPTION REQ.	DRIVE ASSY NO.		
			MAX HP @ 1750	MAX HP @ 1150					
GMS D	875	575	2.00:1	5.65	3.73	56C	STD	90253-510	
				11.70	7.72	143TC/145TC	STD	90253-516	
				11.70	7.72	182C/184C	80F	90253-519	
				13.01	8.59	182TC/184TC	80F	90253-526	
	580	383	3.00:1	3.76	2.48	56C	STD	90253-530	
				8.10	5.35	143TC/145TC	STD	90253-533	
				8.10	5.35	182C/184C	80F	90253-539	
	440	288	4.00:1	10.62	7.01	182TC/184TC	80F	90253-546	
				2.82	1.86	56C	STD	90253-550	
				5.90	3.89	143TC/145TC	STD	90253-553	
	350	230	5.00:1	5.90	3.89	182C/184C	80F	90253-562	
				7.24	4.78	182TC/184TC	80F	90253-566	
				2.26	1.49	56C	STD	90253-570	
				5.20	3.43	143TC/145TC	STD	90253-573	
	GMS G	875	575	2.00:1	5.20	3.43	182C/182C	80F	90253-582
					5.98	3.95	182TC/184TC	80F	90253-586
5.65					3.73	56C	STD	90253-610	
11.70					7.72	143TC/145TC	STD	90253-616	
11.70					7.72	182C/184C	80F	90253-624	
580		383	3.00:1	13.01	8.59	182TC/184TC	80F	90253-626	
				13.01	8.59	213TC/213TC	80J	90253-628	
				3.76	2.48	56C	STD	90253-630	
				8.10	5.35	143TC/145TC	STD	90253-639	
440		288	4.00:1	8.10	5.35	182C/184C	80F	90223-639	
	10.62			7.01	182TC/184TC	80F	90253-646		
	10.62			7.01	213TC/215TC	80J	90253-648		
	2.82			1.86	56C	STD	90253-660		
350	230	5.00:1	5.90	3.89	143TC/145TC	STD	90253-663		
			5.90	3.89	182C/184C	80F	90253-672		
			7.24	4.78	182TC/184TC	80F	90253-675		
			7.24	4.78	213TC	80J	90253-677		
			2.26	1.49	56C	STD	90253-690		
350	230	5.00:1	5.20	3.43	143TC/145TC	STD	90253-693		
			5.20	3.43	182C/184C	80F	90253-702		
			5.89	3.95	182TC/184TC	80F	90253-705		
			5.89	3.95	213TC	80J	90253-707		

(CONT'D)

① Listed reducer horsepower rated for Standard Service (8-10 hrs/day). For Light Service (3-5 hrs/day) multiply maximum rated horsepower by 1.1. For Heavy Service (16-24 hrs/day) multiply maximum rated horsepower by 0.9.

NOTE: CONSULT FACTORY FOR OPTIONS NOT SHOWN.



GMS

GRR REDUCER C-FLANGE FLEX DRIVE OPTIONS

(Drive Assembly Number Includes Base, Coupling, Guard and Gear Reducer, But **NOT** the Motor)

PUMP MODEL	RPM @ 1750	RPM @ 1150	REDUCER ^①		FRAME	MTG.FT. OPTION REQ.	DRIVE ASSY NO.	
			MAX HP @ 1750	MAX HP @ 1150				
GMS J	875	575	2.00:1	13.01	8.59	182TC/184TC	80F	90253-722
				13.01	8.59	213TC/215TC	STD	90253-724
				36.29	23.95	254TC/256TC	80P	90253-728
				36.29	23.95	284TC/286TC	80P	90253-732
	580	383	3.00:1	10.62	7.01	182TC/184TC	80F	90253-735
				10.62	7.01	213TC/215TC	80J	90253-741
	550	365	3.15:1	25.76	17.00	254TC/256TC	80P	90253-743
				25.76	17.00	284TC	80P	90253-746
				42.96	28.35	286TC	80P	90253-747
	440	288	4.00:1	7.24	4.78	182TC/184TC	80F	90253-750
				7.24	4.78	213TC	80J	90253-754
	350	230	5.00:1	5.98	3.95	182TC/184TC	80F	90253-767
				5.98	3.95	213TC	STD	90253-769
				16.01	10.57	215TC	80P	90253-774
				30.49	20.12	254TC/256TC	80J	90253-778
	GMS N	875	575	2.00:1	13.01	8.59	213TC/215TC	STD
36.29					23.95	254TC/256TC	80P	90253-801
36.29					23.95	284TC/286TC	80P	90253-805
580		383	3.00:1	10.62	7.01	213TC/215TC	STD	90253-814
				25.76	17.00	254TC/256TC	80P	90253-819
550		365	3.15:1	42.96	28.35	284TC/286TC	80P	90253-820
				7.24	4.78	213TC	STD	90253-827
350		230	5.00:1	5.98	3.95	213TC	STD	90253-842
				16.01	10.57	215TC	80P	90253-845
				30.49	20.12	254TC/256TC	80P	90253-847
GMS R	640	417	2.76:1	80.20	52.93	324TC	STD	90253-874
				80.20	52.93	364TC	STD	90253-878
	555	365	3.15:1	10.10	6.66	213TC/215TC	STD	90253-881
				25.76	17.00	254TC/256TC	STD	90253-886
				42.96	28.35	284TC/286TC	STD	90253-891
	520	340	3.38:1	66.20	43.69	324TC	STD	90253-896
				66.20	43.69	326TC	STD	90253-898
	440	288	4.00:1	9.42	6.22	184TC	STD	90253-901
				20.00	13.20	213TC/215TC	STD	90253-904
				38.16	25.18	254TC/256TC	STD	90253-909
				38.16	25.18	284TC	STD	90253-913
	420	278	4.13:1	40.40	26.40	286TC	STD	90253-916
				54.40	35.90	324TC	STD	90253-918
	350	230	5.00:1	6.10	4.03	184TC	STD	90253-921
16.01				10.57	213TC/215TC	STD	90253-924	
30.49				20.12	254TC/256TC	STD	90253-929	
30.49				20.12	284TC/286TC	STD	90253-933	

① Listed reducer horsepower rated for Standard Service (8-10 hrs/day). For Light Service (3-5 hrs/day) multiply maximum rated horsepower by 1.1. For Heavy Service (16-24 hrs/day) multiply maximum rated horsepower by 0.9.

NOTE: CONSULT FACTORY FOR OPTIONS NOT SHOWN.



PERFORMANCE CURVES

SPEED VS. CAPACITY/HORSEPOWER

NK

Hydraulic Size

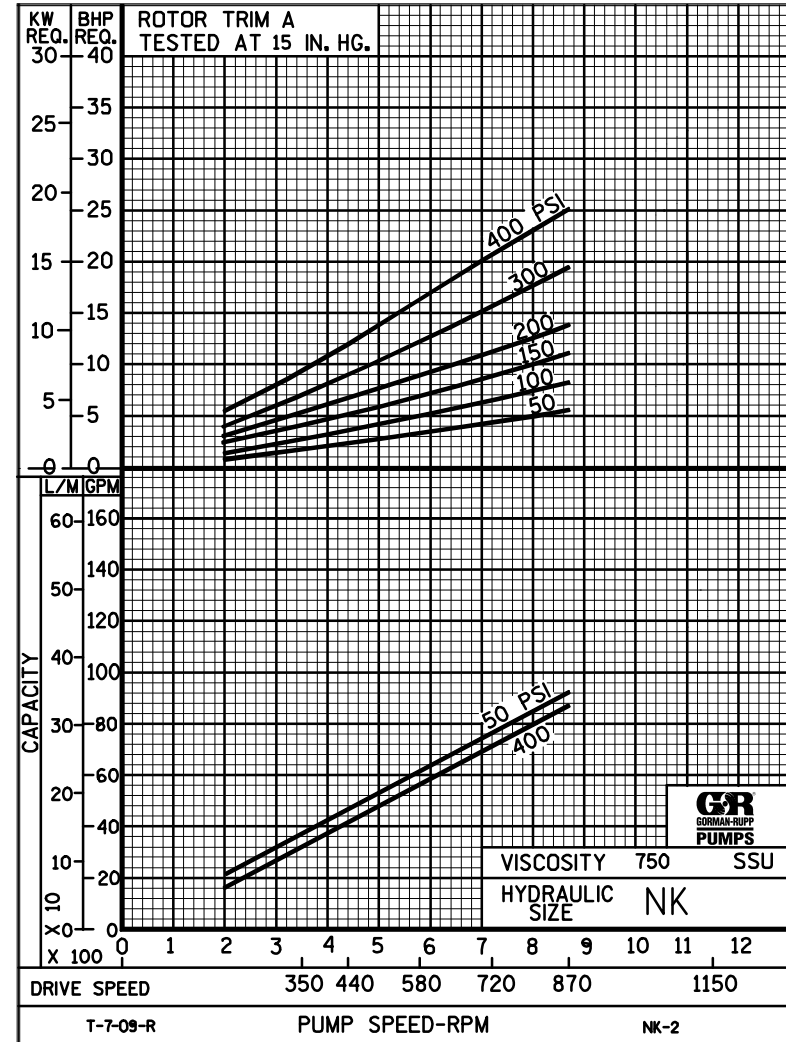
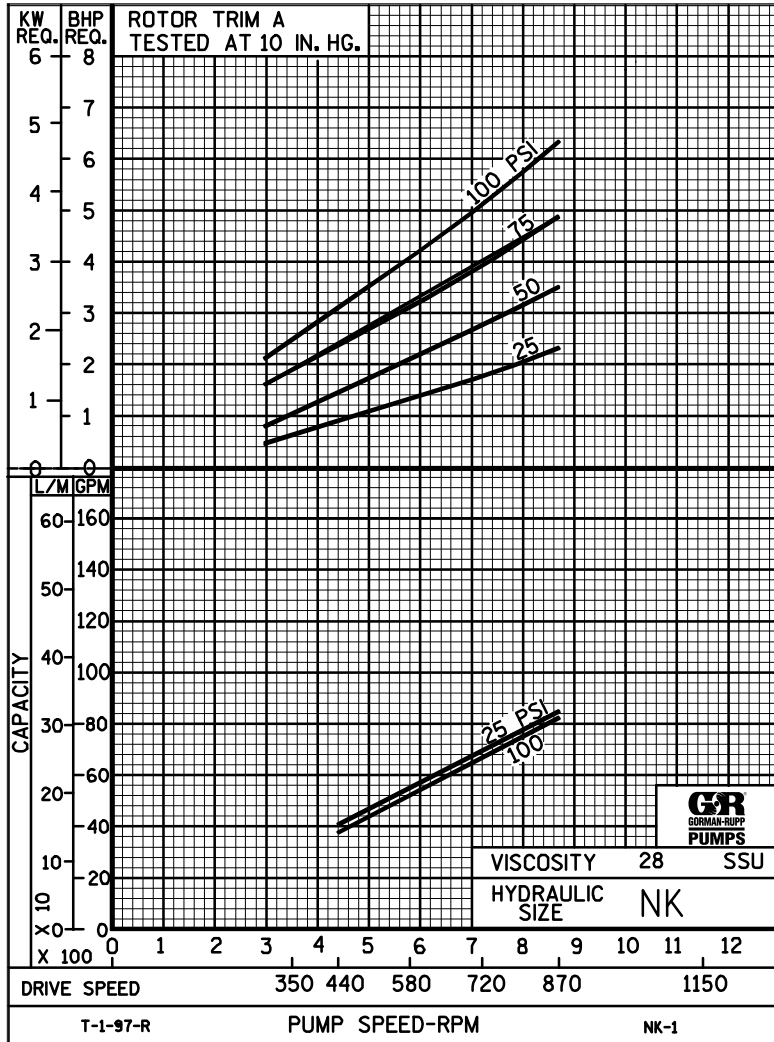

THE GORMAN-RUPP COMPANY • MANSFIELD, OHIO
 GORMAN-RUPP OF CANADA LIMITED • ST. THOMAS, ONTARIO, CANADA



PERFORMANCE CURVES

SPEED VS. CAPACITY/HORSEPOWER

NK Hydraulic Size

SEC. 500

Page 87

January 2010

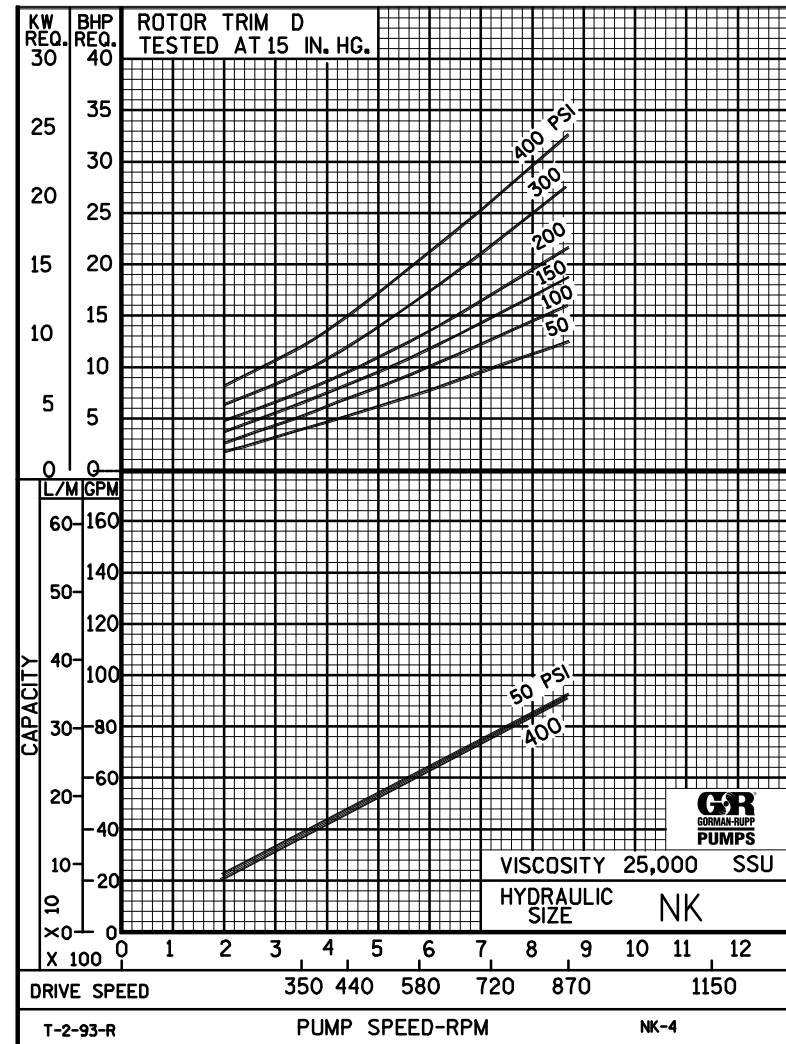
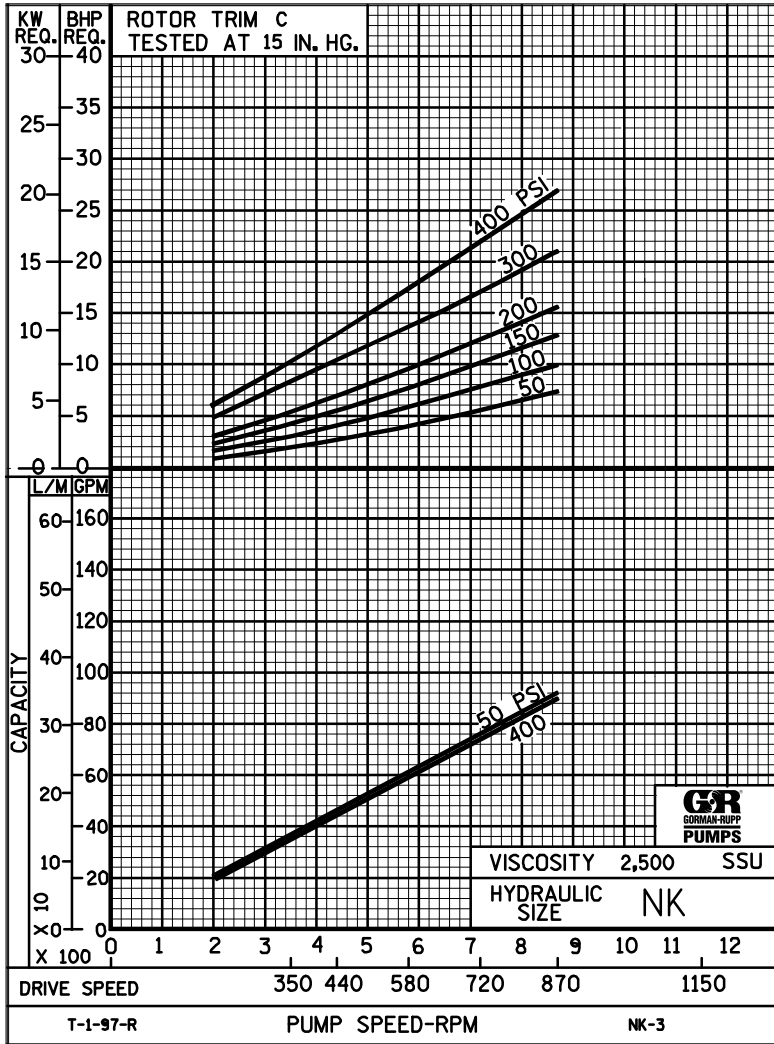

THE GORMAN-RUPP COMPANY • MANSFIELD, OHIO
 GORMAN-RUPP OF CANADA LIMITED • ST. THOMAS, ONTARIO, CANADA

Printed in U.S.A.



NK

PUMP HYDRAULIC SIZE CHART

SEC. 500

Page 88

January 2010

**90 GPM
870 RPM**

NOMINAL		ROTOR TRIM	VISCOSITY (SSU)	N.I.P.R. (PSIA)	FRICTION PIPE LOSS (PSI/FT) <small>(Based on Sch 40 Steel Pipe)</small>					FULL BYPASS RELIEF VALVE PRESSURE (PSI)					CAPACITY (GPM) / H.P. REQUIRED													
CAP. GPM	SPEED RPM				PIPE DIAMETER					CRACKING PRESS. (PSI)					DIFFERENTIAL PRESSURE (PSI)													
					2"	2 1/2"	3"	4"	5"	LOW PRES R/V			HI PRES R/V		MEDIUM DUTY AND HEAVY DUTY				HEAVY DUTY ONLY									
90	870	STD	28	3.1	.01	.01	.01	.01	.01	60	86	116			85	84	83	82										
			32		.05	.02	.01	.01	.01							2.2	3.5	4.9	6.4									
			38	3.1	.07	.03	.01	.01	.01	60	86	116	162			87	86	85	84	82								
			50		.08	.04	.01	.01	.01							2.4	3.6	5.0	6.6	9.5								
			70	3.1	.09	.04	.02	.01	.01	62	88	118	162	208		89	88	87	86	85	82							
			100		.10	.05	.02	.01	.01							3.0	4.1	5.5	7.0	9.9	13							
			150	3.1	.11	.05	.02	.01	.01	62	90	118	166	212		90	89	89	88	87	86	82	80					
			200		.13	.06	.02	.01	.01							3.5	4.6	6.0	7.5	10	13	19	24					
			300	3.1	.14	.06	.02	.01	.01	64	92	120	166	216		91	90	90	90	89	88	85	82					
			500		.15	.07	.03	.01	.01							4.3	5.4	6.8	8.1	11	13	19	25					
		750	3.1	.22	.11	.05	.02	.01	66	94	120	170	220		92	92	92	91	91	90	87	85						
		1,000		.29	.14	.06	.02	.01							4.7	5.6	7.1	8.5	11	14	20	25						
		2,000	3.6	.58	.29	.12	.04	.02	72	100	126	178	228		92	92	92	91	91	91	90	89						
		3,500		1.02	.50	.21	.07	.03							6.9	8.0	9.1	11	13	16	22	27						
		5,000	4.0	1.45	.71	.30	.10	.04	74	102	128	182	232		92	92	92	91	91	91	91	90.1						
		7,500		2.18	1.07	.45	.15	.06							8.2	9.4	11	12	15	18	23	29						
		10,000	4.5	2.90	1.43	.60	.20	.08	76	104	130	186	234		92	92	92	91	91	91	91	90.1						
		15,000		4.35	2.14	.90	.30	.12							9.8	11	13	14	17	20	25	31						
		20,000	4.9	5.80	2.85	1.20	.41	.17	78	106	132	190	238		92	92	92	92	92	91	91	91						
		25,000		7.25	3.56	1.50	.51	.21							12	13	15	16	19	22	27	33						
50,000																												
75,000																												
100,000																												
150,000																												
200,000																												
250,000																												

(NOTE) For speeds not shown on the pump hydraulic charts, consult factory.



NK

PUMP HYDRAULIC SIZE CHART

SEC. 500

Page 89

January 2010

**60 GPM
580 RPM**

NOMINAL		ROTOR TRIM	VISCOSITY (SSU)	N.I.P.R. (PSIA)	FRICTION PIPE LOSS (PSI/FT) <small>(Based on Sch 40 Steel Pipe)</small>					FULL BYPASS RELIEF VALVE PRESSURE (PSI)					CAPACITY (GPM) / H.P. REQUIRED								
CAP. GPM	SPEED RPM				PIPE DIAMETER					CRACKING PRESS. (PSI)					DIFFERENTIAL PRESSURE (PSI)								
		2"	2 1/2"	3"	4"	5"	LOW PRES R/V		HI PRES R/V			MEDIUM DUTY AND HEAVY DUTY				HEAVY DUTY ONLY							
						50	75	100	150	200	25	50	75	100	150	200	300	400					
60	580	STD	28	1.8	.01	.01	.01	.01	.01	57	83	107			55	53	53	52					
			32		.03	.01	.01	.01	.01						1.3	2.2	3.2	4.1					
			38	1.8	.03	.02	.01	.01	.01	57	83	107	157			56	55	54	54	52			
			50		.04	.02	.01	.01	.01						1.5	2.3	3.3	4.2	6.1				
			70	1.8	.05	.02	.01	.01	.01	58	85	109	157	210		58	57	57	56	55	54		
			100		.05	.02	.01	.01	.01							1.7	2.5	3.5	4.4	6.3	8.3		
			150	1.8	.06	.03	.01	.01	.01	58	85	109	157	210		60	59	58	58	57	56	53	48
			200		.06	.03	.01	.01	.01							2.0	2.8	3.7	4.7	6.5	8.5	12	15
			300	1.8	.06	.03	.01	.01	.01	59	87	112	159	212		61	60	59	59	58	58	55	52
			500		.10	.05	.02	.01	.01							2.5	3.2	4.0	5.0	6.8	8.8	12	16
		750	1.8	.15	.07	.03	.01	.01	59	87	112	159	212		61	61	60	60	60	59	57	55	
		1,000		.20	.10	.04	.02	.01							2.8	3.6	4.5	5.4	7.1	9.2	13	16	
		2,000	2.3	.39	.19	.08	.03	.01	63	90	117	170	219		61	61	61	60	60	60	59	59	
		3,500		.68	.33	.14	.05	.02							3.8	4.5	5.4	6.2	8.0	10	14	18	
		5,000	2.6	.97	.48	.20	.07	.03	64	90	117	170	219		62	61	61	61	60	60	60	59	
		7,500		1.45	.71	.30	.10	.04							4.6	5.4	6.2	7.0	8.8	11	14	19	
		10,000	2.9	1.93	.95	.40	.14	.06	65	92	120	174	225		62	61	61	61	61	60	60	59	
		15,000		2.90	1.43	.60	.20	.08							5.7	6.5	7.3	8.2	10	12	16	20	
		20,000	3.2	3.87	1.90	.80	.27	.11	65	92	120	174	225		62	62	61	61	61	61	60	60	
		25,000		4.83	2.38	1.00	.34	.14							6.9	7.6	8.5	9.5	11	13	17	21	
50,000	4.8	9.66	4.75	2.00	.67	.27	70	98	126	179	232		62	62	61	61	61	61	60	60			
75,000		14.5	7.12	2.99	1.01	.41							9.6	11	12	13	15	17	21	25			
100,000	6.5	19.3	9.49	3.98	1.35	.55	75	104	132	185	238		62	62	61	61	61	61	60	60			
150,000		-	-	-	-	-							12	13	14	15	18	21	26	32			
200,000																							
250,000																							

(NOTE) For speeds not shown on the pump hydraulic charts, consult factory.

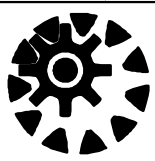

NK

PUMP HYDRAULIC SIZE CHART

SEC. 500

Page 90
January 2010

36 GPM
350 RPM

NOMINAL		ROTOR TRIM	VISCOSITY (SSU)	N.I.P.R. (PSIA)	FRICTION PIPE LOSS (PSI/FT) <small>(Based on Sch 40 Steel Pipe)</small>					FULL BYPASS RELIEF VALVE PRESSURE (PSI)					CAPACITY (GPM) / H.P. REQUIRED													
CAP. GPM	SPEED RPM				PIPE DIAMETER					CRACKING PRESS. (PSI)					DIFFERENTIAL PRESSURE (PSI)													
					2"	2 1/2"	3"	4"	5"	LOW PRES R/V			HI PRES R/V		MEDIUM DUTY AND HEAVY DUTY				HEAVY DUTY ONLY									
36	350	STD	28	1.1	.01	.01	.01	.01	.01	54	80	106				32	31	31	30									
			32		.01	.01	.01	.01	.01							.73	1.3	1.9	2.5									
			38	1.1	.02	.01	.01	.01	.01	54	80	106	156			34	33	32	31	29								
			50		.02	.01	.01	.01	.01							.74	1.4	2.0	2.5	3.8								
			70	1.1	.02	.01	.01	.01	.01	55	81	108	157	208		35	34	33	32	31	28							
			100		.02	.01	.01	.01	.01							.77	1.5	2.1	2.6	3.8	4.8							
			150	1.1	.02	.01	.01	.01	.01	55	81	108	157	208		36	36	35	34	33	32	30	27					
			200		.03	.01	.01	.01	.01							.80	1.6	2.2	2.7	3.9	4.9	7.2	10					
			300	1.1	.04	.02	.01	.01	.01	56	82	110	159	210		37	36	36	35	34	33	32	31					
			500		.06	.03	.01	.01	.01							.87	1.8	2.3	2.9	4.0	5.1	7.3	9.6					
		750	1.1	.09	.05	.02	.01	.01	56	82	110	159	210		37	37	36	36	35	35	34	33						
		1,000		.12	.06	.03	.01	.01							1.1	2.0	2.6	3.2	4.5	5.7	8.1	10						
		2,000	1.4	.23	.12	.05	.02	.01	58	84	112	162	212		37	37	37	37	36	36	35	35						
		3,500		.41	.20	.09	.03	.01							1.5	2.3	2.9	3.5	4.6	5.8	8.2	11						
		5,000	1.6	.58	.29	.12	.04	.02	58	84	112	164	214		37	37	37	37	36	36	36	35						
		7,500		.87	.43	.18	.06	.03							1.9	2.8	3.3	3.9	5.1	6.2	8.7	11						
		10,000	1.9	1.16	.57	.24	.08	.04	60	86	114	166	216		37	37	37	37	36	36	36	36						
		15,000		1.74	.86	.36	.12	.05							2.6	3.3	3.9	4.5	5.7	6.8	9.3	11						
		20,000	2.2	2.32	1.14	.49	.16	.07	60	86	114	168	216		37	37	37	37	36	36	36	36						
		25,000		2.90	1.43	.60	.20	.08							3.5	4.0	4.6	5.1	6.4	7.5	9.8	12						
50,000	3.4	5.80	2.85	1.20	.41	.17	62	88	116	170	218		37	37	37	37	36	36	36	36								
75,000		8.70	4.27	1.79	.61	.25							4.9	5.6	6.4	7.1	8.3	9.7	12	14								
100,000	5.6	11.6	5.70	2.39	.81	.33	66	92	120	174	222		37	37	37	37	36	36	36	36								
150,000		17.4	8.55	3.59	1.21	.49							6.1	7.0	7.9	8.8	10	12	15	16								
200,000	8.8	23.2	11.4	4.78	1.61	.65	70	96	125	179	228		37	37	37	37	36	36	36	36								
250,000		29.0	14.3	5.97	2.02	.82							7.3	8.3	9.5	11	12	14	16	18								

(NOTE) For speeds not shown on the pump hydraulic charts, consult factory.