

Basic Pedestal Standard Centrifugal Pump



Model VGH2 1/2D31-B

Size 4" x 2 1/2"

PUMP SPECIFICATIONS

Size: 4" x 2 1/2" (102 mm x 64 mm) Raised Face Flanges.

Casing: Ductile Iron.

Maximum Operating Pressure 114 psi (786 kPa).*

Enclosed Type, Five Vane Impeller: Gray Iron 40.

Handles 11/32" (9 mm) Diameter Spherical Solids.

Impeller Shaft: Steel 1045.

Two Replaceable Wear Rings: Gray Iron 25.

Seal Plate: Ductile Iron.

Bypass Flush Piping.

Bearing Housing: Gray Iron 25.

Radial Bearing: Open Cylindrical Roller.

Thrust Bearing: Open Double Row Ball.

Bearing Lubrication: SAE 30 Non-Detergent Oil.

Gaskets: Nitrile Rubber.

Hardware: Standard Plated Steel.

Bearing Housing Level Oiler.

Optional Equipment: Strainer. NPT Suction and Discharge Flanges. Consult Factory for Optional Seals.

**Consult Factory for Applications Exceeding Maximum Pressure and/or Temperature Indicated.*

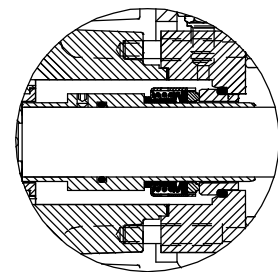
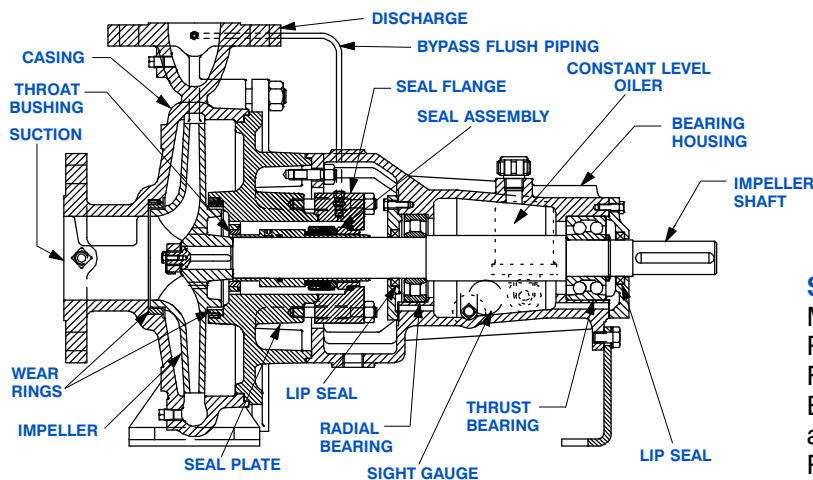

SEAL DETAIL

Mechanical, Self-Lubricated. Silicon Carbide Rotating and Stationary Faces. Fluorocarbon Elastomers (DuPont Viton® or Equivalent). Stainless Steel 316 Shaft Sleeve and Spring. Maximum Temperature of Liquid Pumped, 160°F (71°C).*



GORMAN-RUPP PUMPS

www.grpumps.com

Specifications Subject to Change Without Notice

Printed in U.S.A.

Specification Data

SECTION 70, PAGE 276

APPROXIMATE
DIMENSIONS and WEIGHTS

NET WEIGHT: 279 LBS. (127 KG.)
SHIPPING WEIGHT: 289 LBS. (131 KG.)
EXPORT CRATE SIZE: 13.2 CU. FT. (0,4 CU. M.)

DISCHARGE:
.75/[19,0] DIA. 4 HOLES EQUALLY SPACED ON A
5.50/[139,7] DIA. B.C. OR OPTIONAL 2.50-8 NPT
COMPANION FLANGE

SUCTION:
.75/[19,0] DIA. 8 HOLES
EQUALLY SPACED ON A
7.50/[190,5] DIA. B.C. OR
OPTIONAL 4.00-8 NPT
COMPANION FLANGE

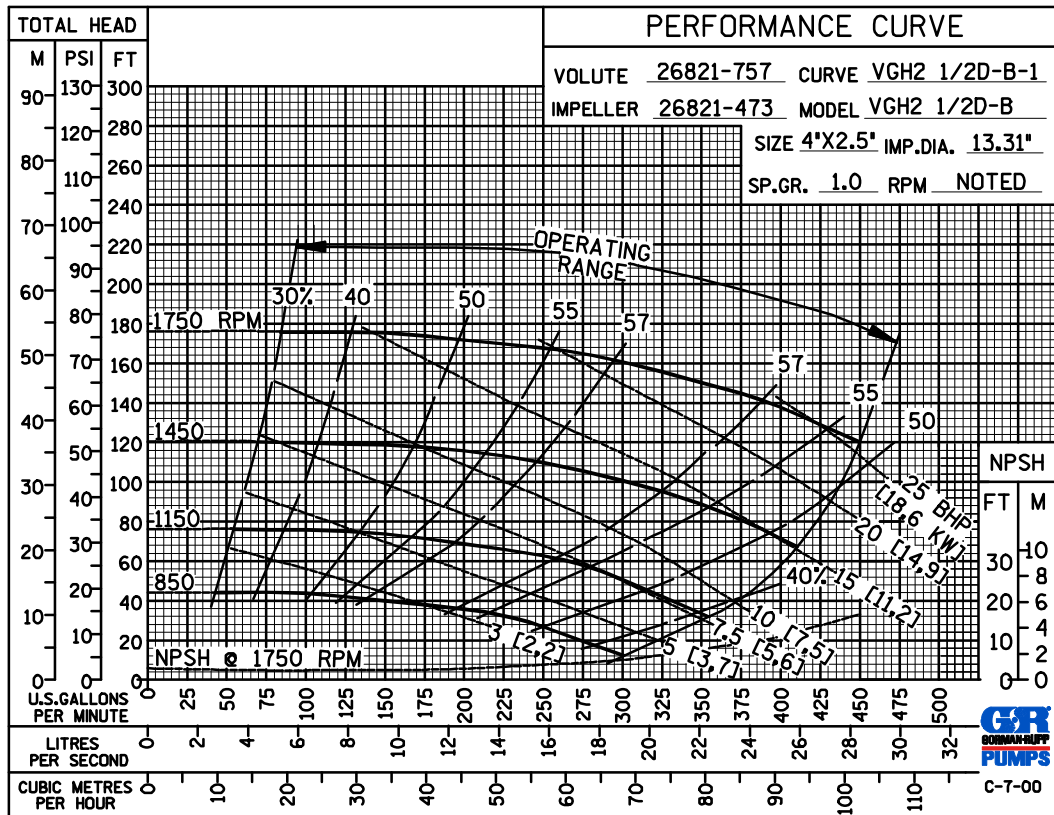
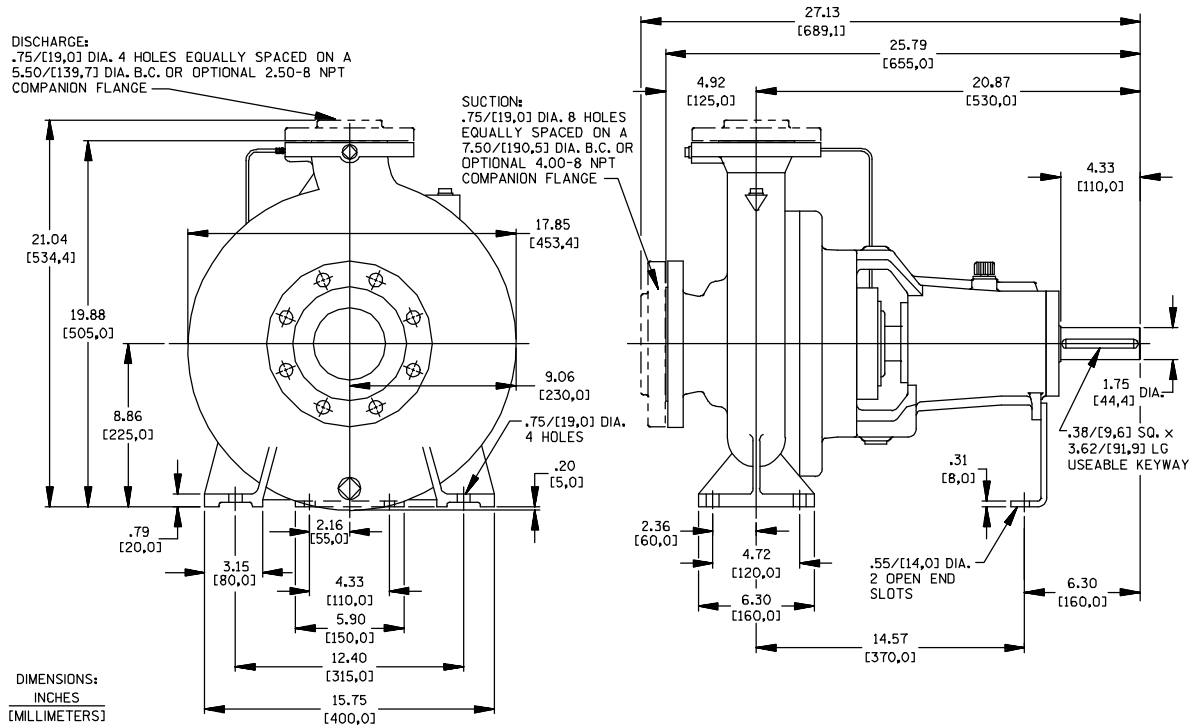

GORMAN-RUPP PUMPS

www.grpumps.com

Specifications Subject to Change Without Notice

Printed in U.S.A.

PERFORMANCE
BASED ON
WATER

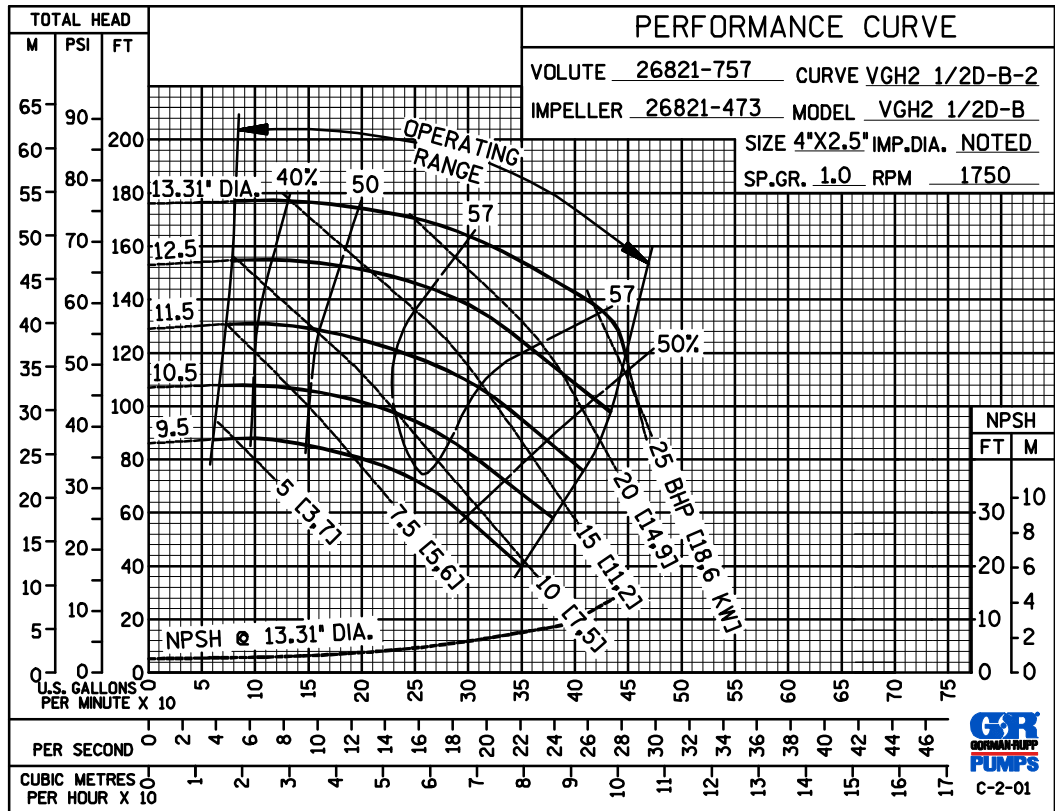

PERFORMANCE
BASED ON
WATER

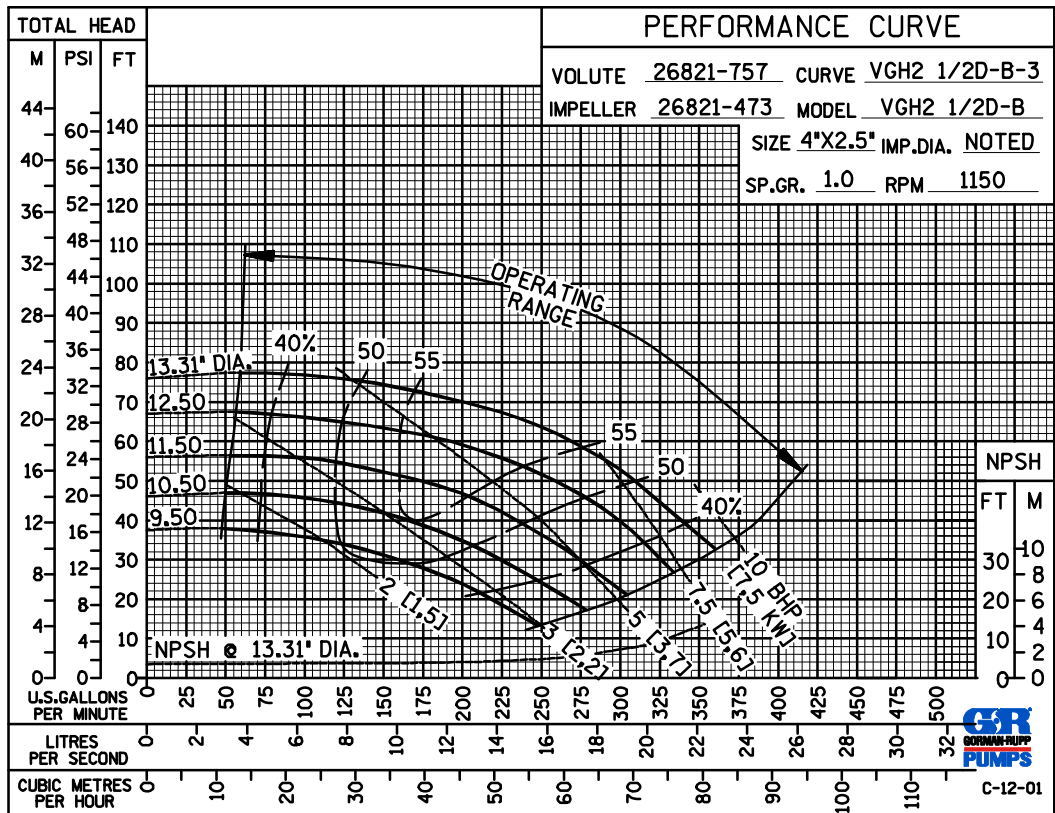

GORMAN-RUPP PUMPS

www.grpumps.com

Specifications Subject to Change Without Notice

Printed in U.S.A.

PERFORMANCE
BASED ON
WATER

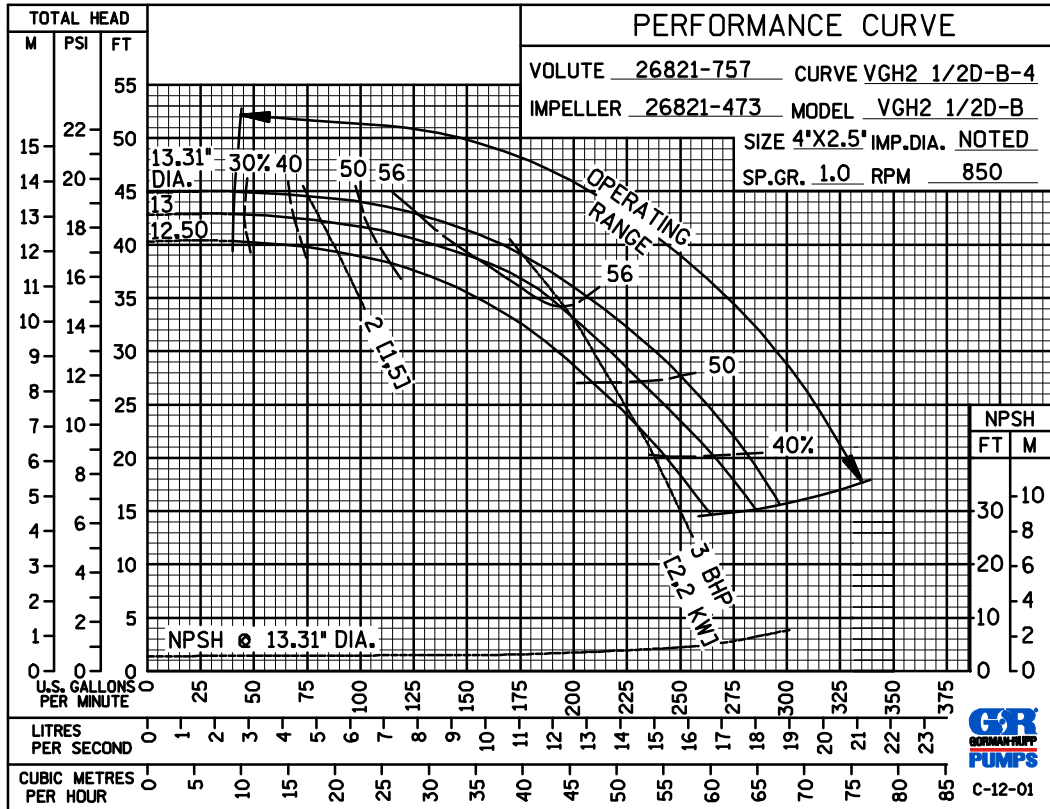

PERFORMANCE
BASED ON
PETROLEUM

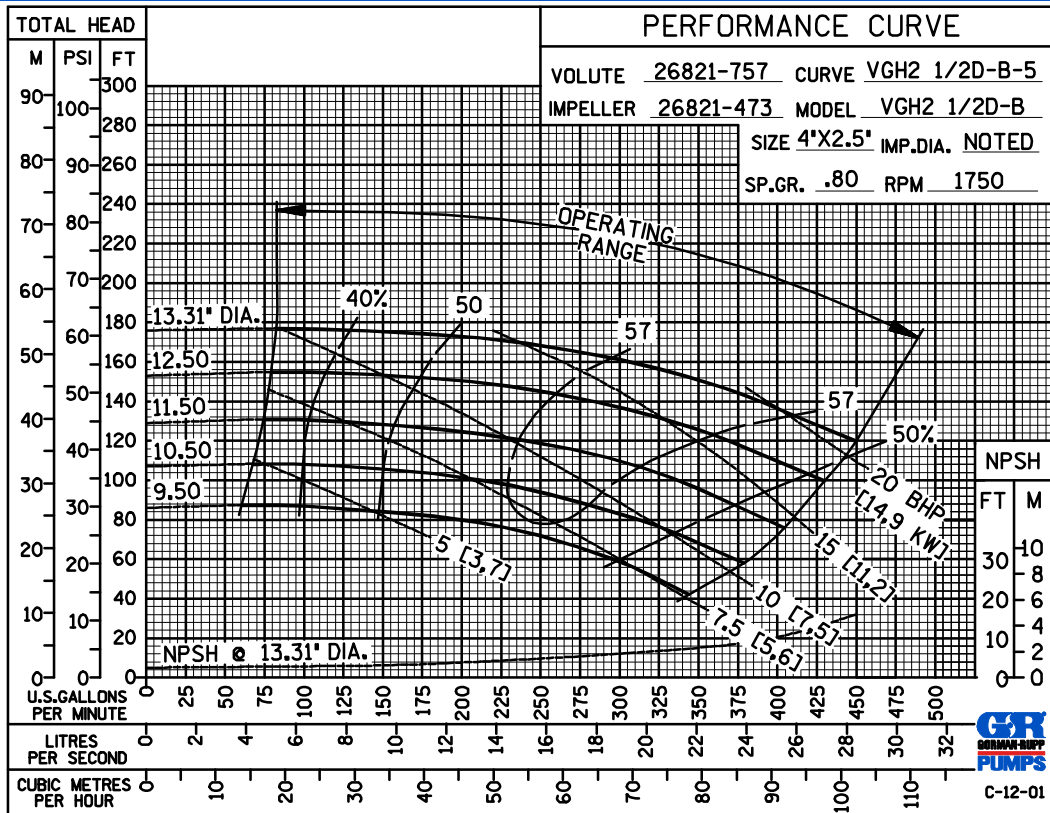

GORMAN-RUPP PUMPS

www.grpumps.com

Specifications Subject to Change Without Notice

Printed in U.S.A.

PERFORMANCE
BASED ON
PETROLEUM

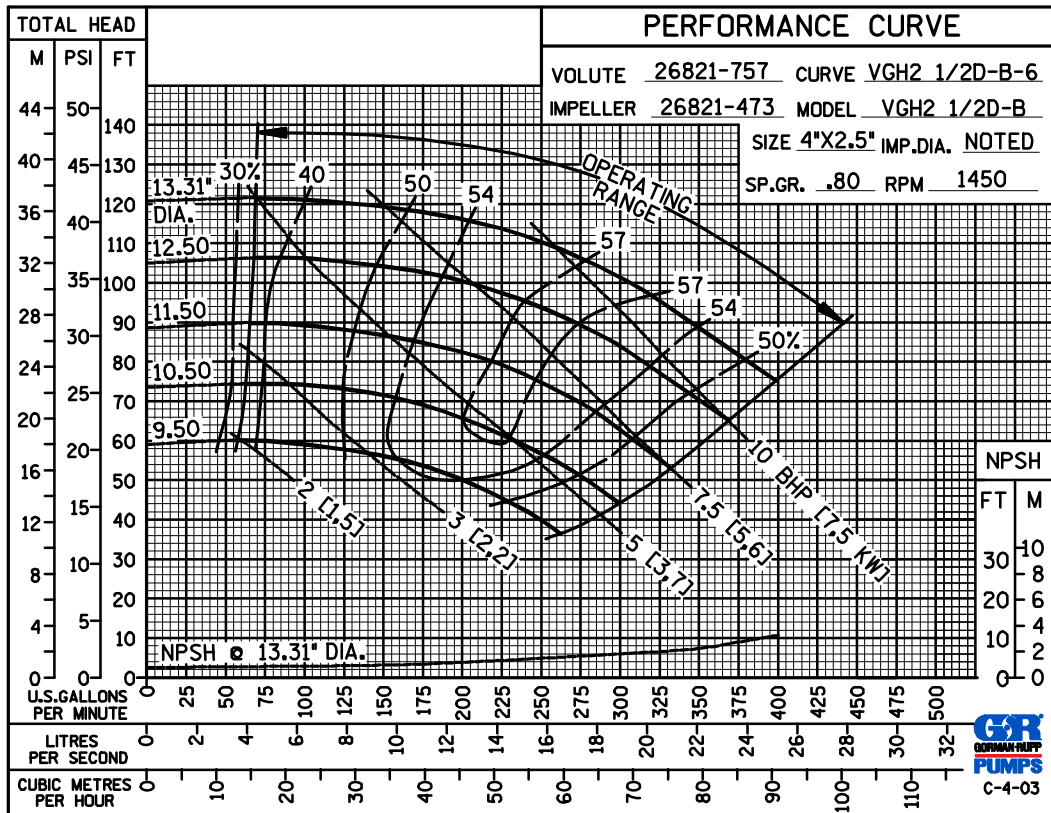

GORMAN-RUPP PUMPS

www.grpumps.com

Specifications Subject to Change Without Notice

Printed in U.S.A.