



Self Priming Centrifugal Pump

Model T4C60SC-B



VARIOUS PATENTS APPLY

Size 4" x 4"



PUMP SPECIFICATIONS

- Size:** 4" x 4" (101 mm x 101 mm) NPT - Female.
- Casing:** Gray Iron 30.
- Maximum Operating Pressure** 83 psi (572 kPa).*
- Semi-Open Type, Two Vane Impeller:** Ductile Iron 65-45-12.
Handles 3" (76,2 mm) Diameter Spherical Solids.
- Impeller Shaft:** Alloy Steel 4150.
- Shaft Sleeve:** Alloy Steel 4130.
- Replaceable Self-Cleaning Wear Plate:** Carbon Steel ASTM A6.
- Adjustable Back Cover Plate:** Gray Iron 30.
- Removable Inspection Cover Plate:** Gray Iron 30; 12 lbs. (5,4 kg.).
- Flap Valve:** Neoprene ^W/Nylon and Steel Reinforcing.
- Seal Plate:** Gray Iron 30.
- Bearing Housing:** Gray Iron 30.
- Radial Bearing:** Open Single Row Ball.
- Thrust Bearing:** Open Double Row Ball.
- Bearing and Seal Cavity Lubrication:** SAE 30 Non-Detergent Oil.
- Flanges:** Gray Iron 30.
- Gaskets:** Buna-N, Compressed Synthetic Fibers, Vegetable Fiber, PTFE, Cork, and Rubber.
- O-Rings:** Buna-N.
- Hardware:** Standard Plated Steel.
- Brass Pressure Relief Valve.**
- Bearing and Seal Cavity Oil Level Sight Gauges.**
- Optional Equipment:** Tungsten Titanium Carbide Seal. Metal Bellows Seal. Automatic Air Release Valve. 120V/240V Casing Heater. High Pump Temperature Shutdown Kit. G-R Hard Iron Casing. Gray Iron 30 Suction and Discharge Spool Flanges:
4" ASA (**Specify Model T4C60SC-B /F**).
100 mm DIN 2527 (PN 16) (**Specify Model T4C60SC-B /FM**).



Shown with Optional Suction and Discharge Spool Flanges (Available in ASA or DIN Standard Sizes).

*Consult Factory for Applications Exceeding Maximum Pressure and/or Temperature Indicated.

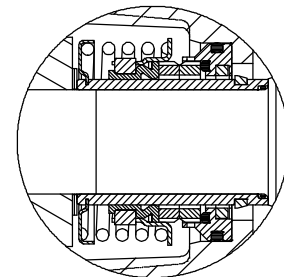
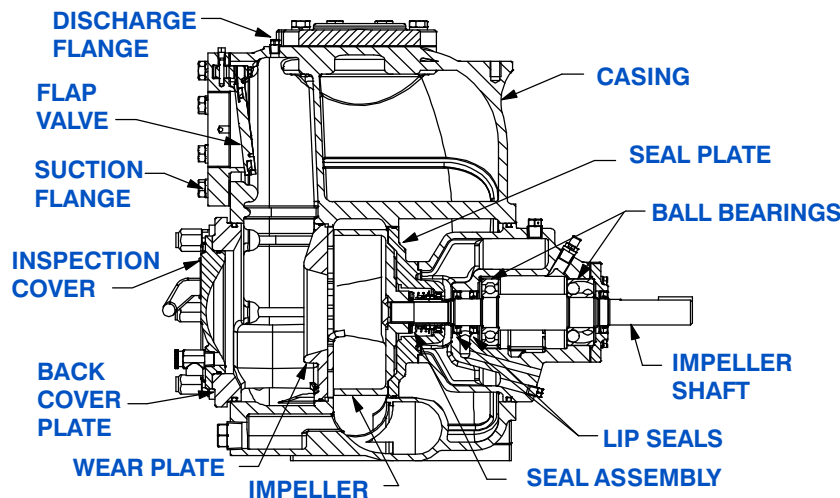

SEAL DETAIL

Cartridge Type, Mechanical, Oil-Lubricated, Double Floating, Self-Aligning. Silicon Carbide Rotating and Stationary Faces. Stainless Steel 316 Stationary Seat. Fluorocarbon Elastomers (DuPont Viton[®] or Equivalent). Stainless Steel 18-8 Cage and Spring. Maximum Temperature of Liquid Pumped, 160°F (71°C).*



GORMAN-RUPP PUMPS

www.grpumps.com

Specifications Subject to Change Without Notice

Printed in U.S.A.

Specification Data

SECTION 55, PAGE 2190

APPROXIMATE DIMENSIONS and WEIGHTS

NET WEIGHT: 635 LBS. (288 KG.)*
SHIPPING WEIGHT: 665 LBS. (302 KG.)*
EXPORT CRATE: 22.7 CU. FT. (0,64 CU. M.)
***ADD 15 LBS. (6,8 KG.) W/EACH SPOOL FLANGE**

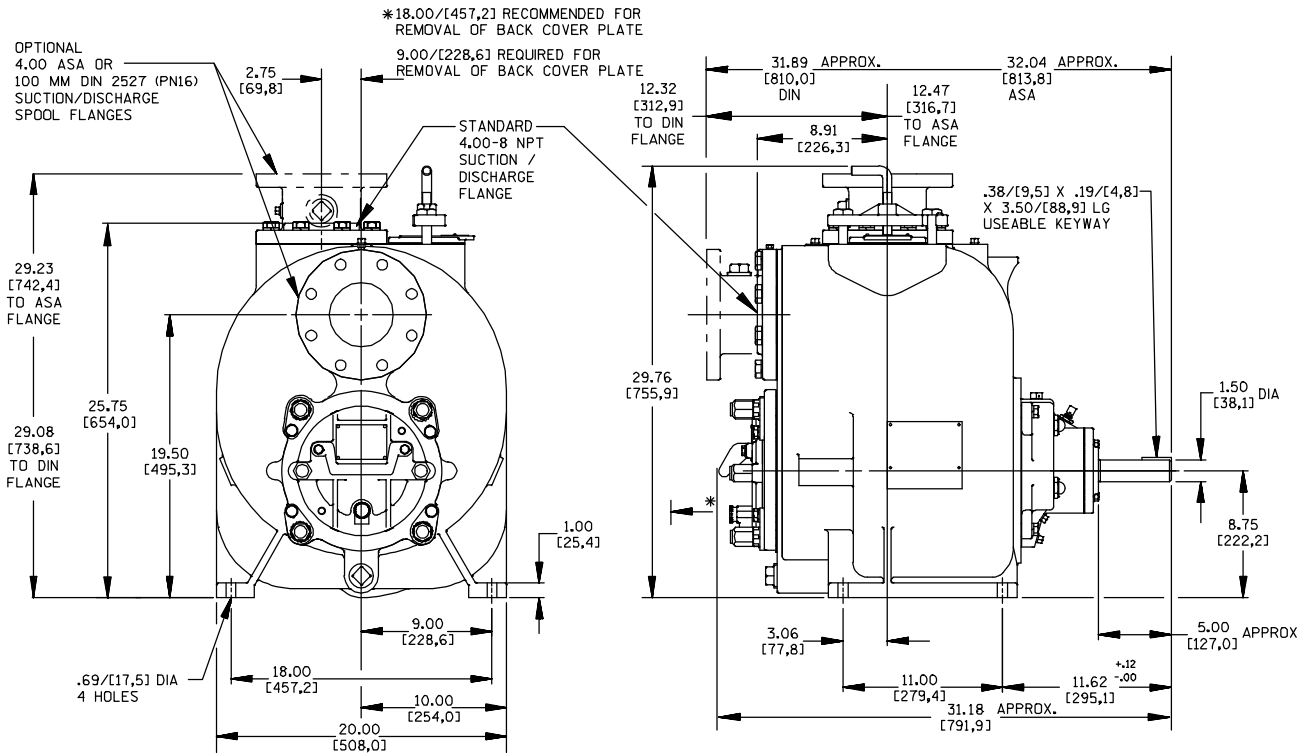

OPTIONAL ASA OR DIN STANDARD SUCTION & DISCHARGE SPOOL FLANGES AVAILABLE

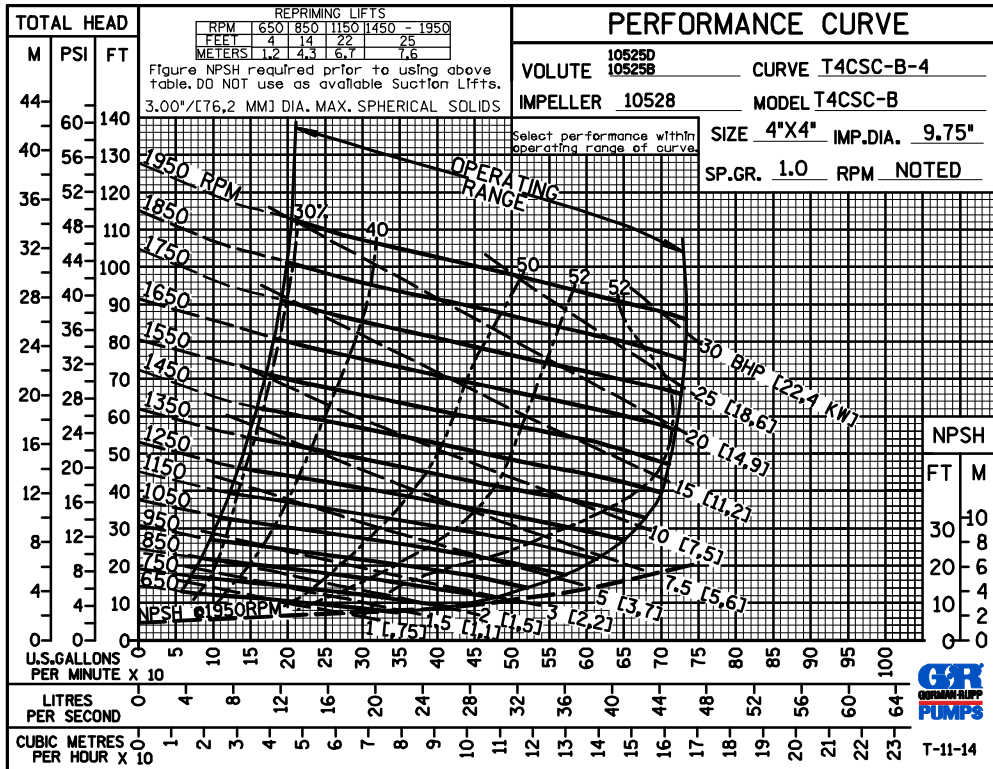

GORMAN-RUPP PUMPS

www.grpumps.com

Specifications Subject to Change Without Notice

Printed in U.S.A.