



# Self Priming Centrifugal Pump

## Model T2A71-B

Size 2" x 2"

VARIOUS PATENTS APPLY

### PUMP SPECIFICATIONS

**Size:** 2" x 2" (51 mm x 51 mm) NPT - Female.

**Casing:** Gray Iron 30.

Maximum Operating Pressure 79 psi (545 kPa).\*

**Semi-Open Type, Two Vane Impeller:** G-R Hard Iron.

Handles 1 1/2" (38,1 mm) Diameter Spherical Solids.

**Impeller Shaft:** Alloy Steel 4150.

**Shaft Sleeve:** Alloy Steel 4130.

**Replaceable Wear Plate:** Hardened Alloy Steel.

**Removable Cover Plate:** Gray Iron 30; 20 lbs. (9 kg).

**Seal Plate:** G-R Hard Iron.

**Externally Replaceable Flap Valve:** Neoprene w/Steel Reinforcing.

**Bearing Housing:** Gray Iron 30.

**Radial Bearing:** Open Single Row Ball.

**Thrust Bearing:** Open Double Row Ball.

**Bearing and Seal Cavity Lubrication:** SAE 30 Non-Detergent Oil.

**Flanges:** Gray Iron 30.

**Gaskets:** Buna-N, Vegetable Fiber, Cork and Rubber.

**O-Rings:** Buna-N.

**Hardware:** Standard Plated Steel.

**Brass Pressure Relief Valve.**

**Bearing and Seal Cavity Oil Level Sight Gauges.**

**Optional Equipment:** Automatic Air Release Valve. 120V/240V

Casing Heater. High Pump Temperature Shutdown Kit.

Self-Cleaning Wear Plate.

Gray Iron 30 Suction and Discharge Spool Flanges:

2" ASA (**Specify Model T2A71-B /F**).

50 mm DIN 2527 (PN 16) (**Specify Model T2A71-B /FM**).

*\*Consult Factory for Applications Exceeding Maximum Pressure and/or Temperature Indicated.*



Shown with Optional Suction & Discharge Spool Flanges (Available in ASA or DIN Standard Sizes).

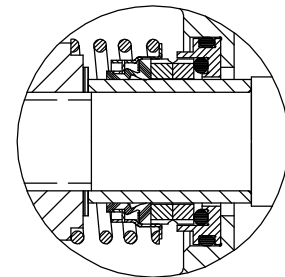
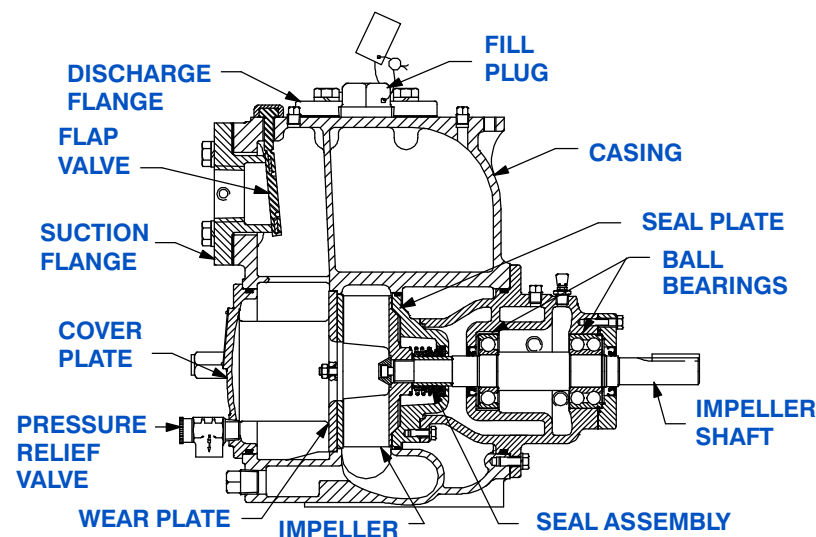

### SEAL DETAIL

Mechanical, Oil-Lubricated, Double Floating, Self-Aligning. Silicon Carbide Rotating and Stationary Faces. Stainless Steel 316 Stationary Seat. Fluorocarbon Elastomers (DuPont Viton® or Equivalent). Stainless Steel 18-8 Cage and Spring. Maximum Temperature of Liquid Pumped, 160°F (71°C).\*



GORMAN-RUPP PUMPS

www.grpumps.com

Specifications Subject to Change Without Notice

Printed in U.S.A.

### Specification Data

SECTION 55, PAGE 988

APPROXIMATE  
DIMENSIONS and WEIGHTS

**NET WEIGHT:** 220 LBS. (100 KG.)\*  
**SHIPPING WEIGHT:** 230 LBS. (104 KG.)\*  
**EXPORT CRATE:** 7.9 CU. FT. (0,22 CU. M.)  
**\*ADD 8 LBS. (3,6 KG.) W/EACH SPOOL FLANGE**

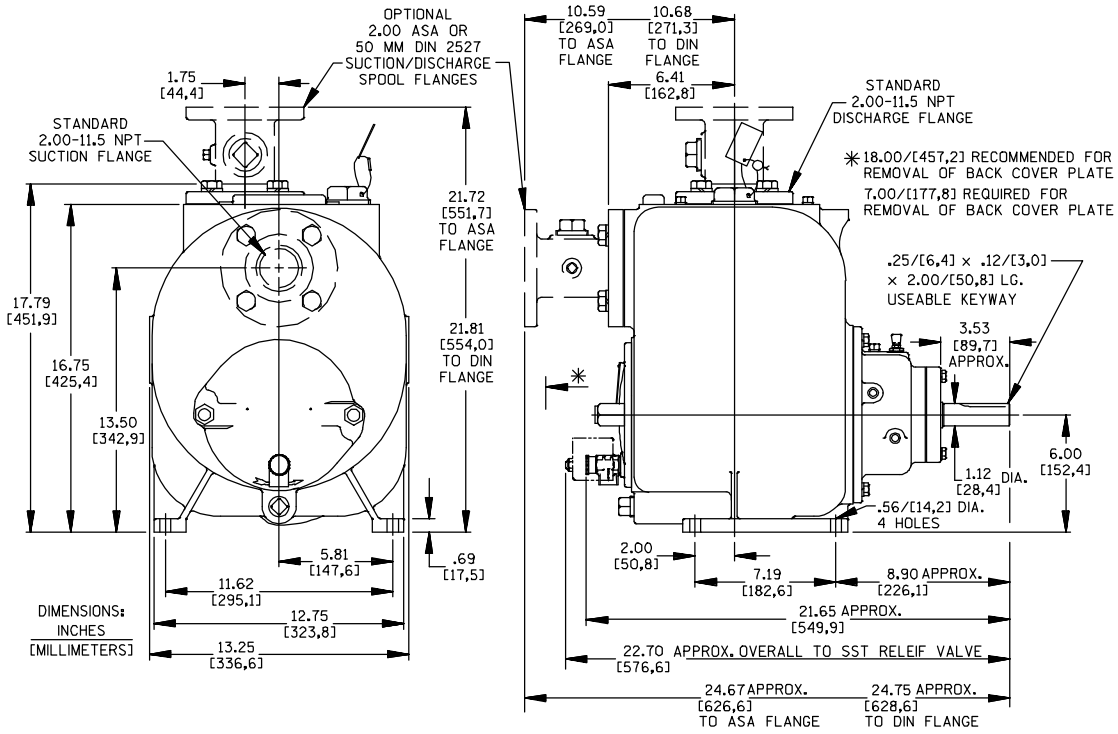

OPTIONAL ASA OR DIN STANDARD SUCTION & DISCHARGE SPOOL FLANGES AVAILABLE

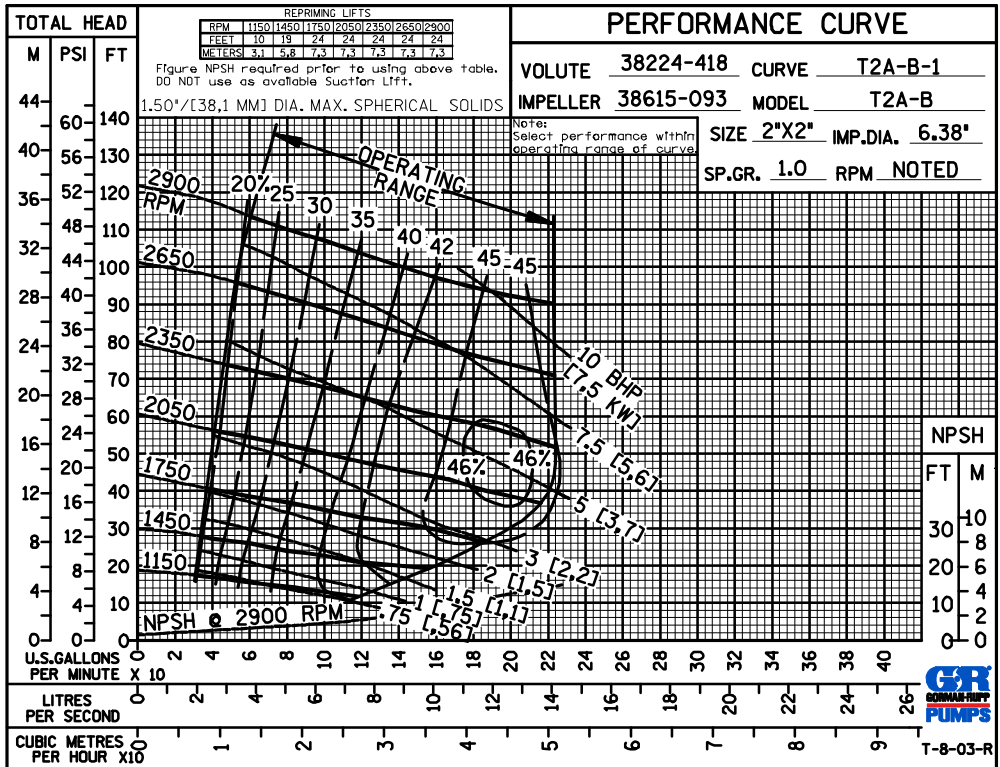

## GORMAN-RUPP PUMPS

www.grpumps.com

Specifications Subject to Change Without Notice

Printed in U.S.A.

**MULTI-SPEED  
PERFORMANCE  
BASED ON  
WATER  
TRIMMED  
IMPELLER**

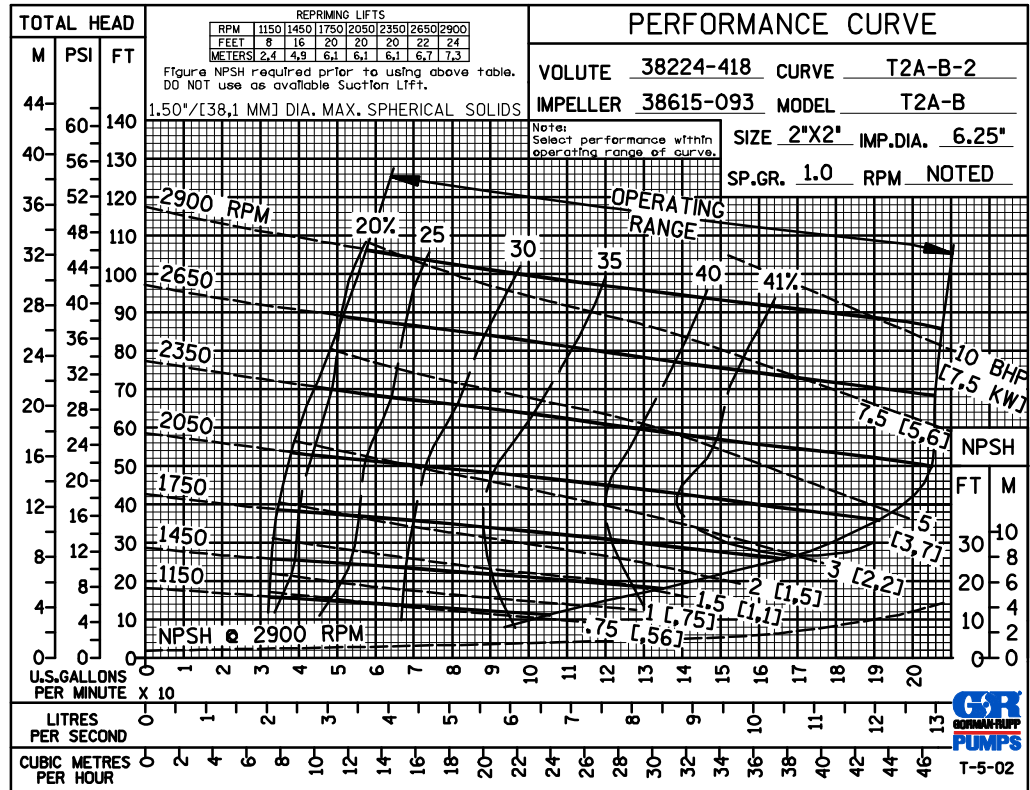

**MULTI-SPEED  
PERFORMANCE  
BASED ON  
WATER  
TRIMMED  
IMPELLER**

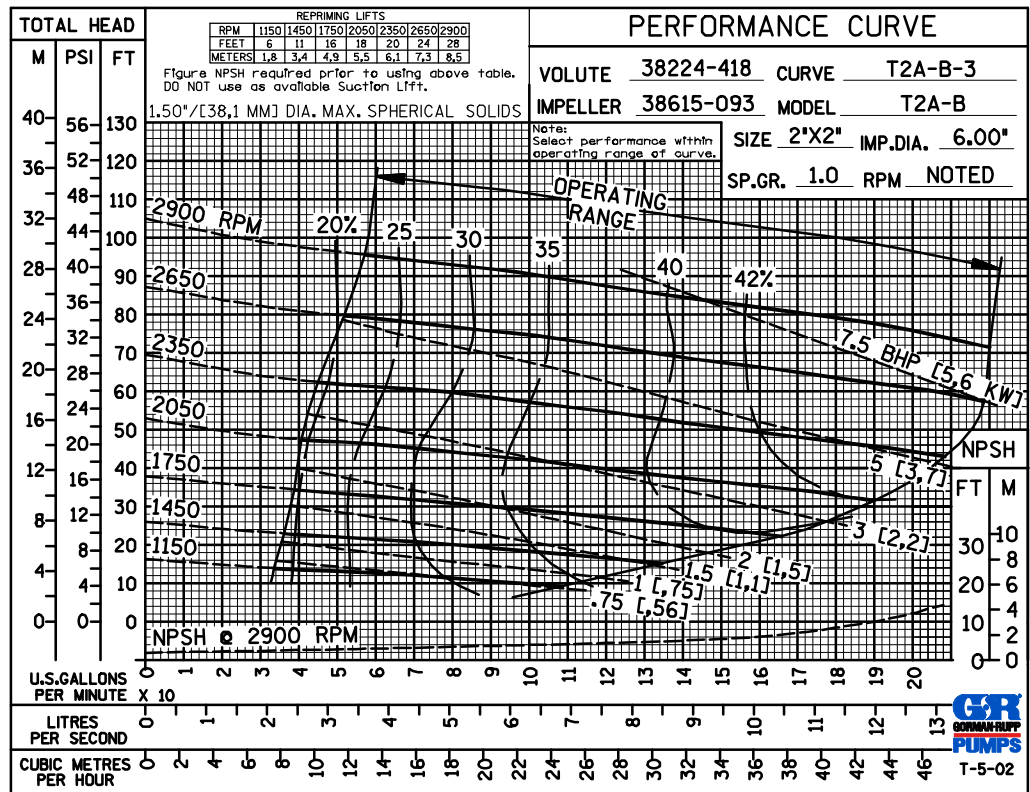

**GORMAN-RUPP PUMPS**

www.grpumps.com

Specifications Subject to Change Without Notice

Printed in U.S.A.

**MULTI-SPEED  
PERFORMANCE  
BASED ON  
WATER  
TRIMMED  
IMPELLER**

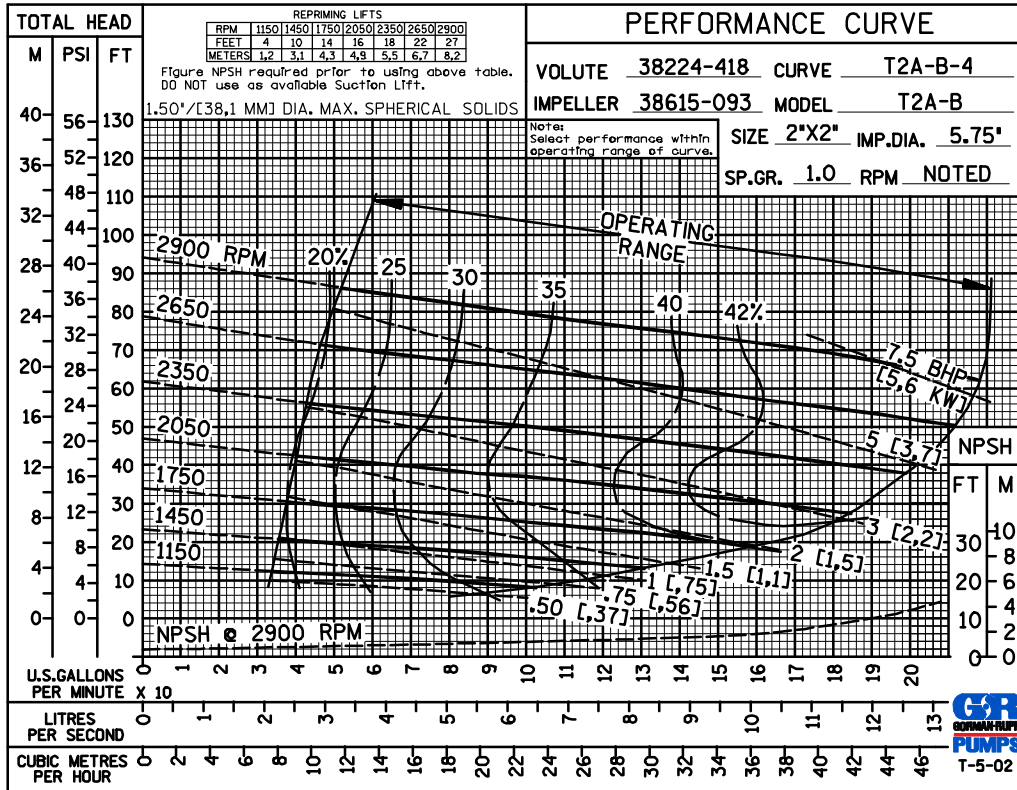

**MULTI-SPEED  
PERFORMANCE  
BASED ON  
WATER  
TRIMMED  
IMPELLER**

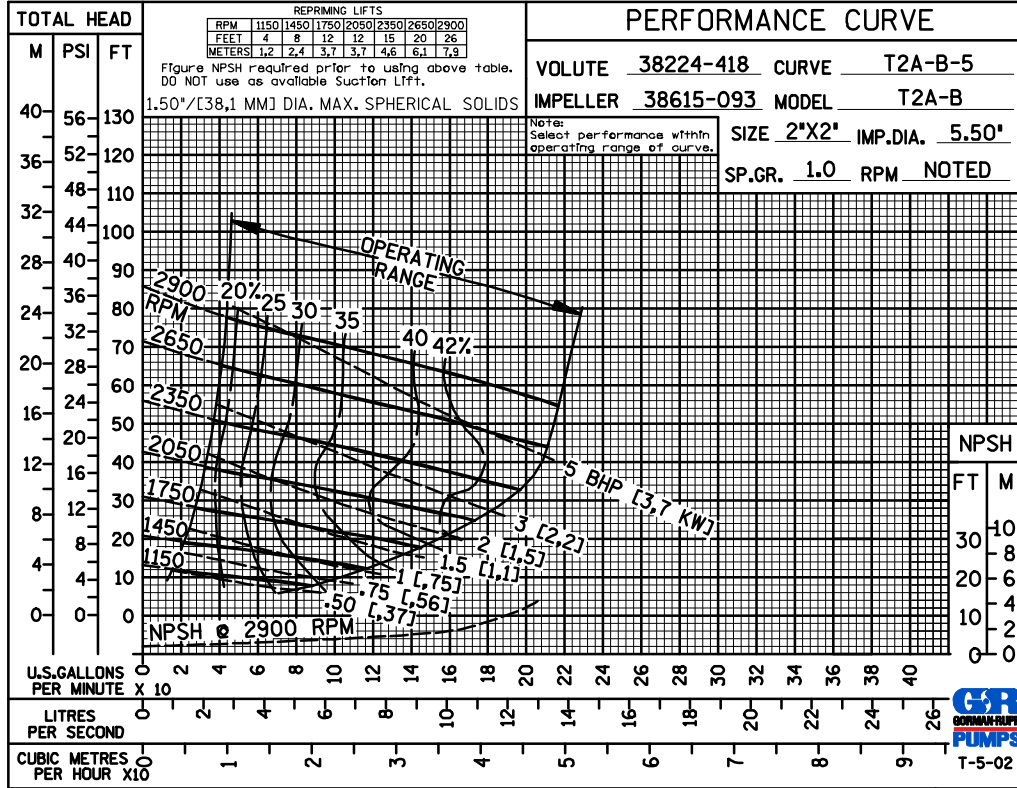

GORMAN-RUPP PUMPS

www.grpumps.com

Specifications Subject to Change Without Notice

Printed in U.S.A.

PERFORMANCE  
BASED ON  
WATER  
TRIMMED  
IMPELLER

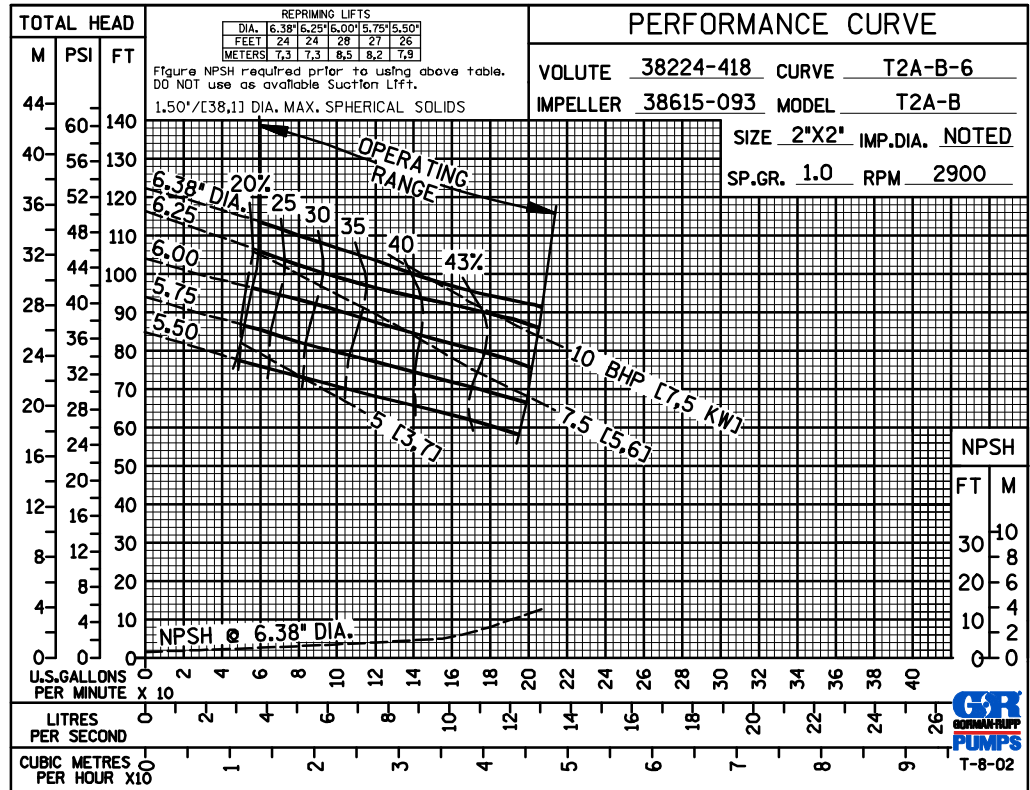

PERFORMANCE  
BASED ON  
WATER  
TRIMMED  
IMPELLER

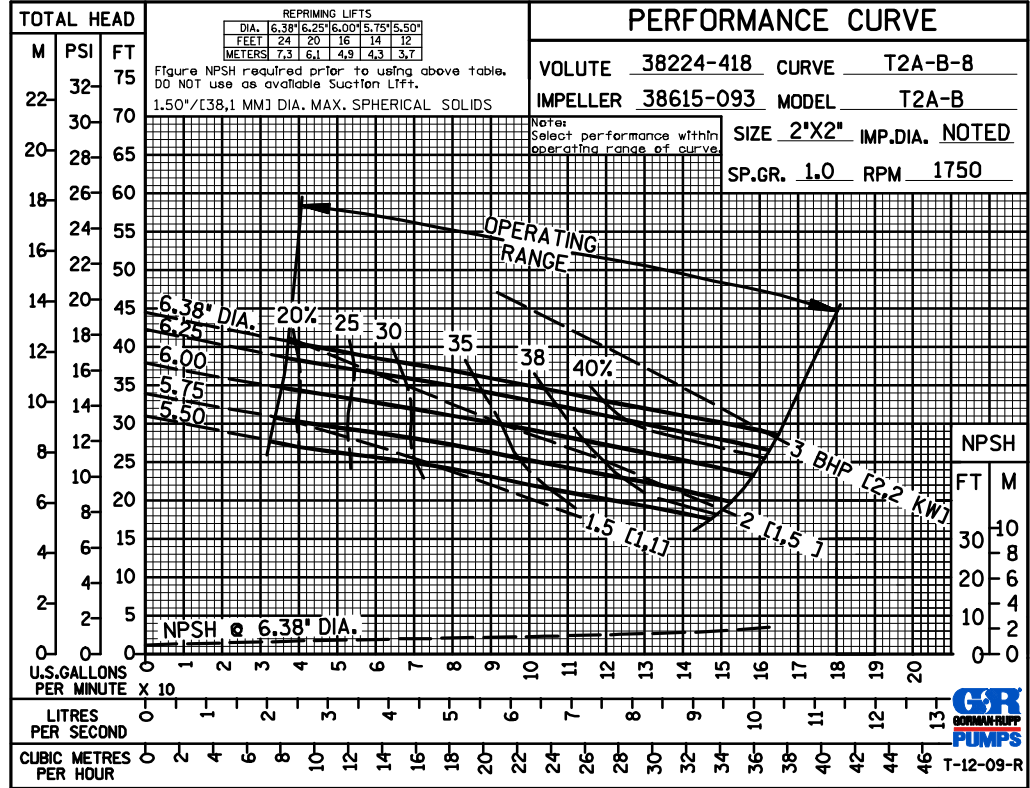

GORMAN-RUPP PUMPS

www.grpumps.com

Specifications Subject to Change Without Notice

Printed in U.S.A.

PERFORMANCE  
BASED ON  
WATER  
TRIMMED  
IMPELLER

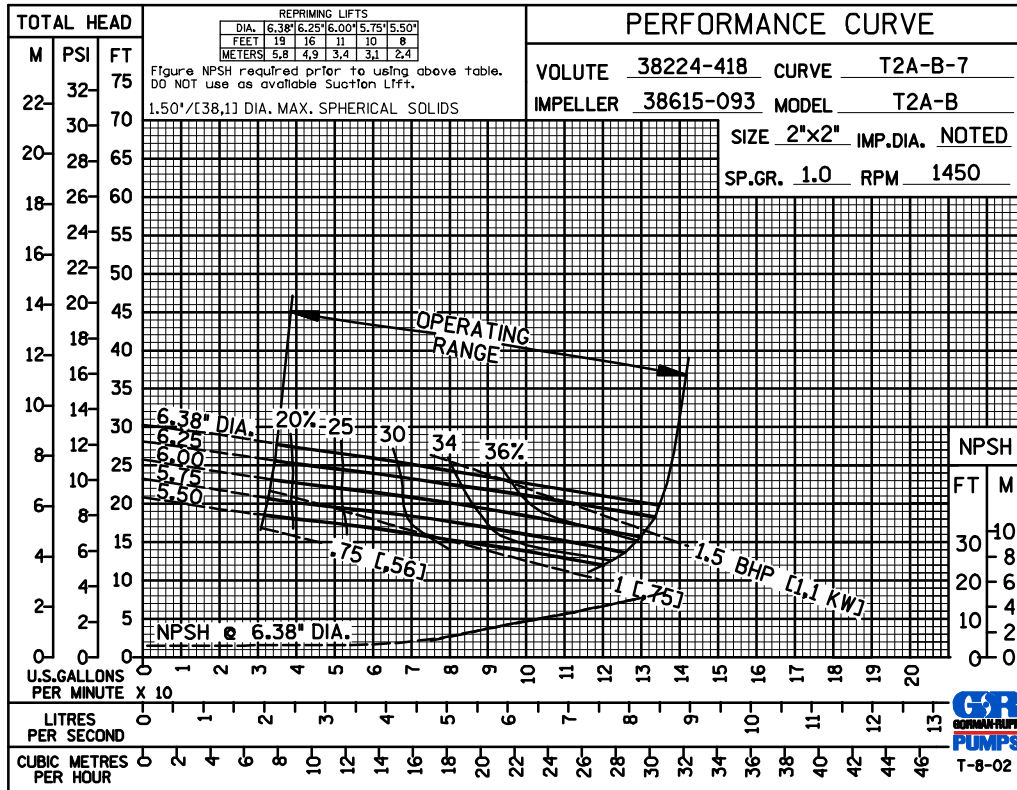

PERFORMANCE  
BASED ON  
WATER  
TRIMMED  
IMPELLER

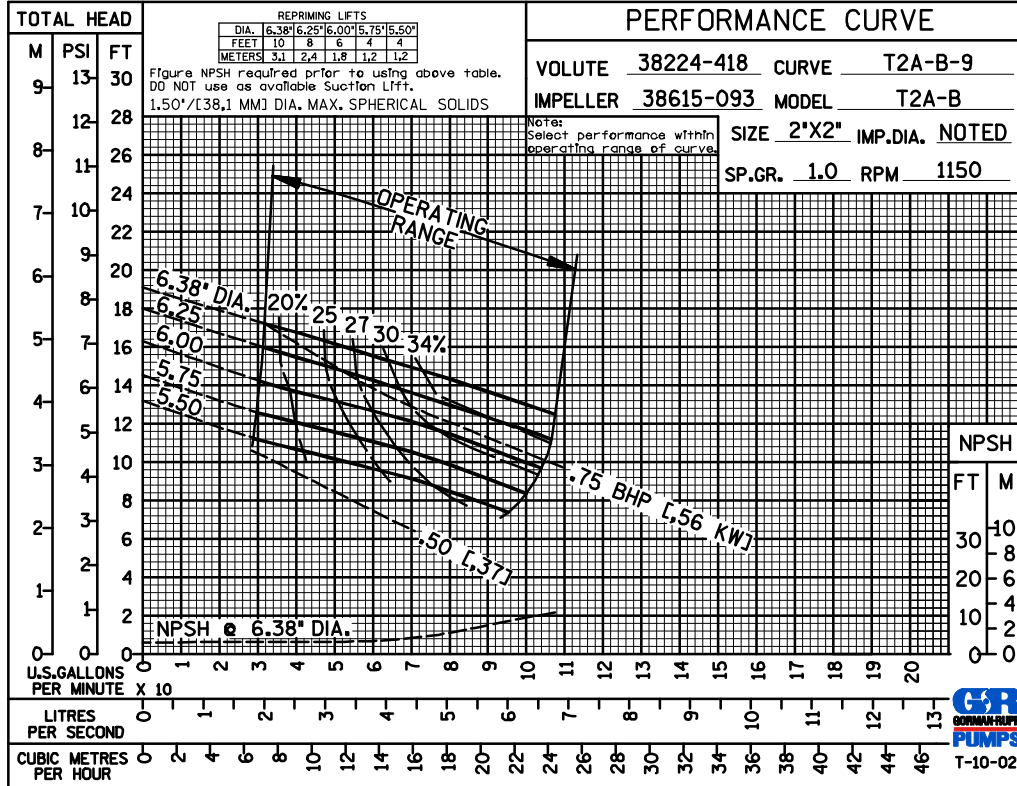

GORMAN-RUPP PUMPS

www.grpumps.com

Specifications Subject to Change Without Notice

Printed in U.S.A.

PERFORMANCE  
BASED ON  
WATER  
PUMPS IN  
PARALLEL

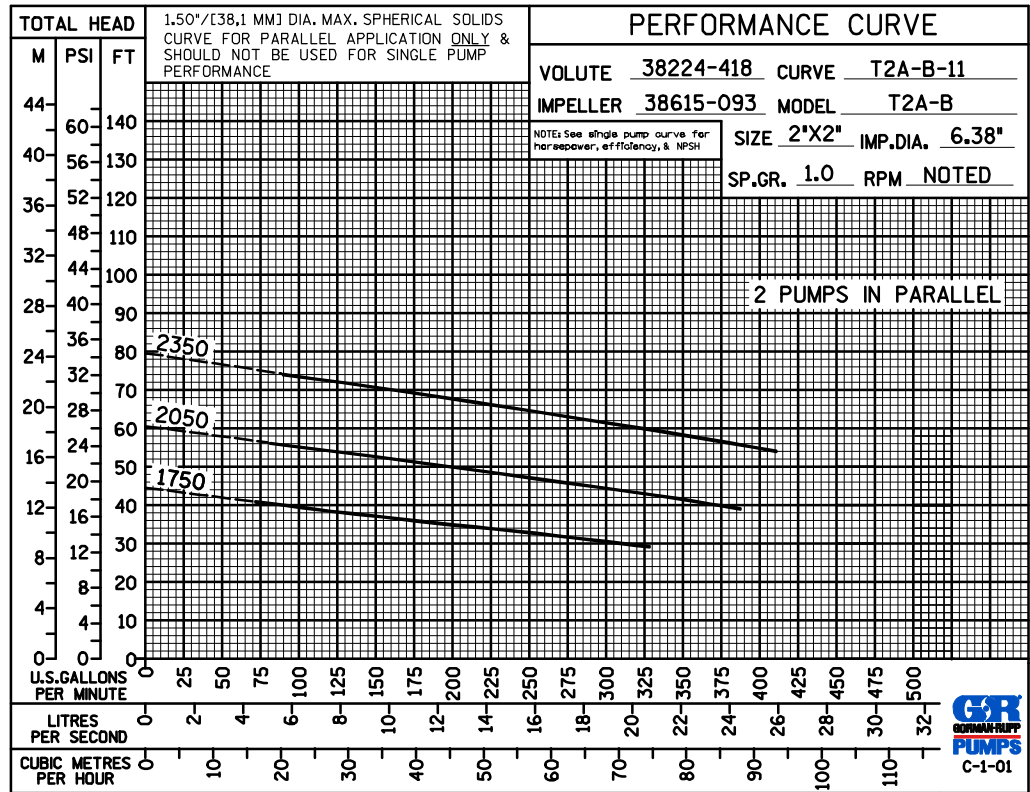

PERFORMANCE  
BASED ON  
WATER  
PUMPS IN  
SERIES

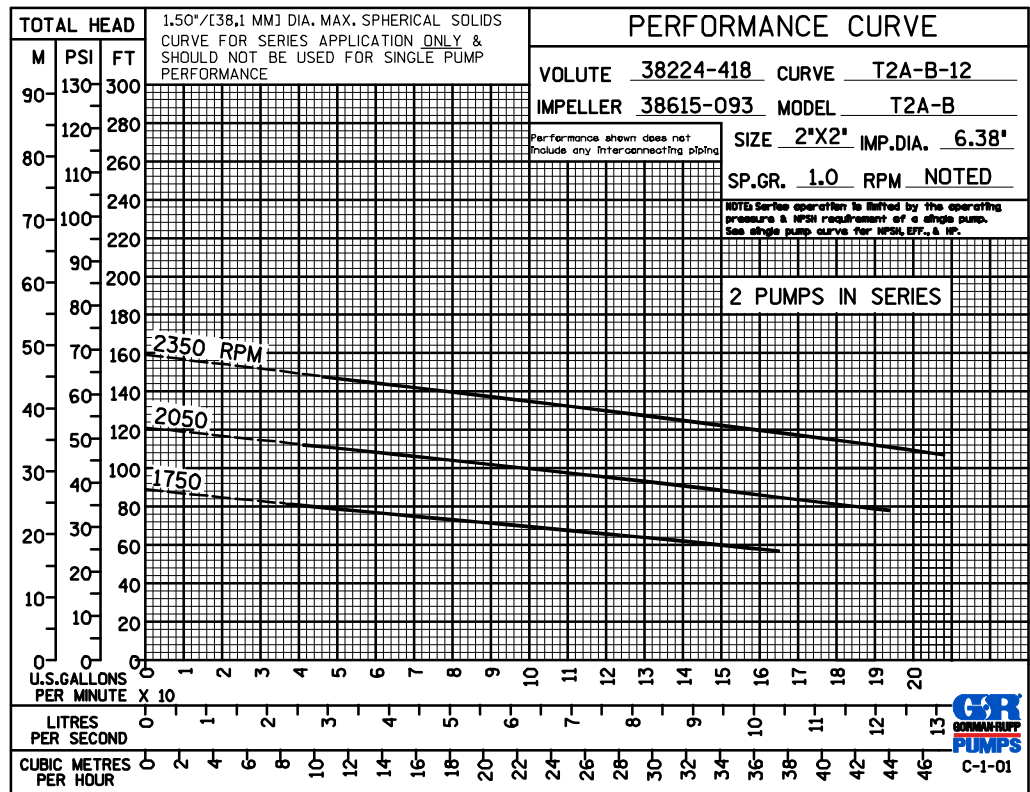

GORMAN-RUPP PUMPS

www.grpumps.com

Specifications Subject to Change Without Notice

Printed in U.S.A.