



VARIOUS PATENTS APPLY

# Self Priming Centrifugal Pump

## Model T2A65-B

Size 2" x 2"

### PUMP SPECIFICATIONS

**Size:** 2" x 2" (51 mm x 51 mm) NPT - Female.

**Casing:** Stainless Steel CD4MCu.

Maximum Operating Pressure 79 psi (545 kPa).\*

**Semi-Open Type, Two Vane Impeller:** Stainless Steel CD4MCu.

Handles 1 1/2" (38,1 mm) Diameter Spherical Solids.

**Impeller Shaft:** Stainless Steel 17-4 PH.

**Shaft Sleeve:** Stainless Steel 316.

**Replaceable Wear Plate:** Stainless Steel CD4MCu.

**Removable Cover Plate:** Stainless Steel CD4MCu; 20 lbs. (9 kg).

**Seal Plate:** Stainless Steel CD4MCu.

**Externally Replaceable Flap Valve:** Fluorocarbon (DuPont Viton® or Equivalent) w/Steel Reinforcing.

**Bearing Housing:** Stainless Steel CD4MCu.

**Radial Bearing:** Open Single Row Ball.

**Thrust Bearing:** Open Double Row Ball.

**Bearing and Seal Cavity Lubrication:** SAE 30 Non-Detergent Oil.

**Flanges:** 125# Stainless Steel 316.

**Gaskets:** Fluorocarbon (DuPont Viton® or Equivalent).

**O-Rings:** Fluorocarbon (DuPont Viton® or Equivalent).

**Hardware:** Stainless Steel 316.

**Stainless Steel 316 Pressure Relief Valve.**

**Bearing and Seal Cavity Oil Level Sight Gauges.**

**Optional Equipment:** Automatic Air Release Valve.

120V/240V Casing Heater. High Pump Temperature

Shutdown Kit. Self-Cleaning Wear Plate.

Stainless Steel CD4MCu Suction

and Discharge Spool Flanges:

2" ASA (**Specify Model T2A65-B /F**).

50 mm DIN 2527 (PN 16) (**Specify Model T2A65-B /FM**).

\*Consult Factory for Applications Exceeding Maximum Pressure and/or Temperature Indicated.



Shown with Optional Suction & Discharge Spool Flanges (Available in ASA or DIN Standard Sizes).

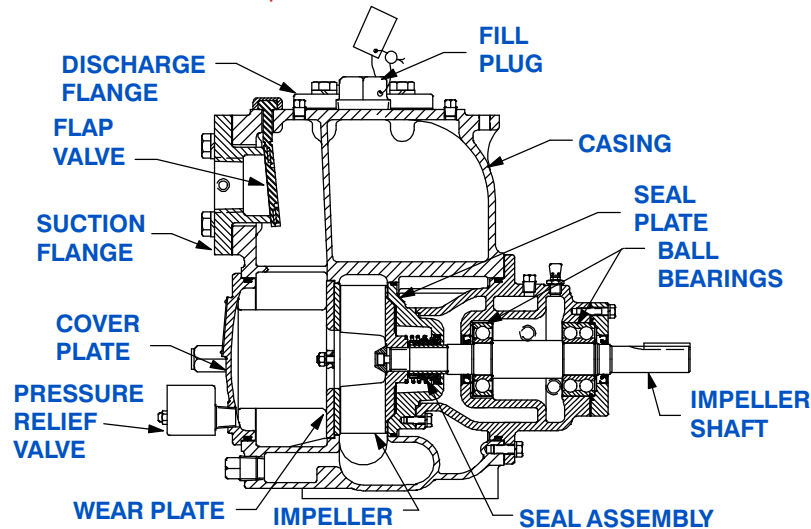
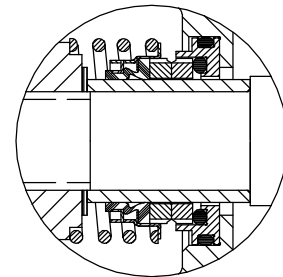

### SEAL DETAILS

Mechanical, Oil-Lubricated, Double Floating, Self-Aligning. Silicon Carbide Rotating and Stationary Faces. Stainless Steel 316 Stationary Seat. Fluorocarbon Elastomers (DuPont Viton® or Equivalent). Stainless Steel 316 Cage and Spring. Maximum Temperature of Liquid Pumped, 160°F (71°C).\*



GORMAN-RUPP PUMPS

www.grpumps.com

Specifications Subject to Change Without Notice

Printed in U.S.A.

**Specification Data**

SECTION 55, PAGE 987

**APPROXIMATE DIMENSIONS and WEIGHTS**

**NET WEIGHT: 230 LBS. (104 KG.)\***  
**SHIPPING WEIGHT: 240 LBS. (109 KG.)\***  
**EXPORT CRATE: 7.9 CU. FT. (0,22 CU. M.)**  
**\*ADD 9 LBS. (4,1 KG.) W/EACH SPOOL FLANGE**

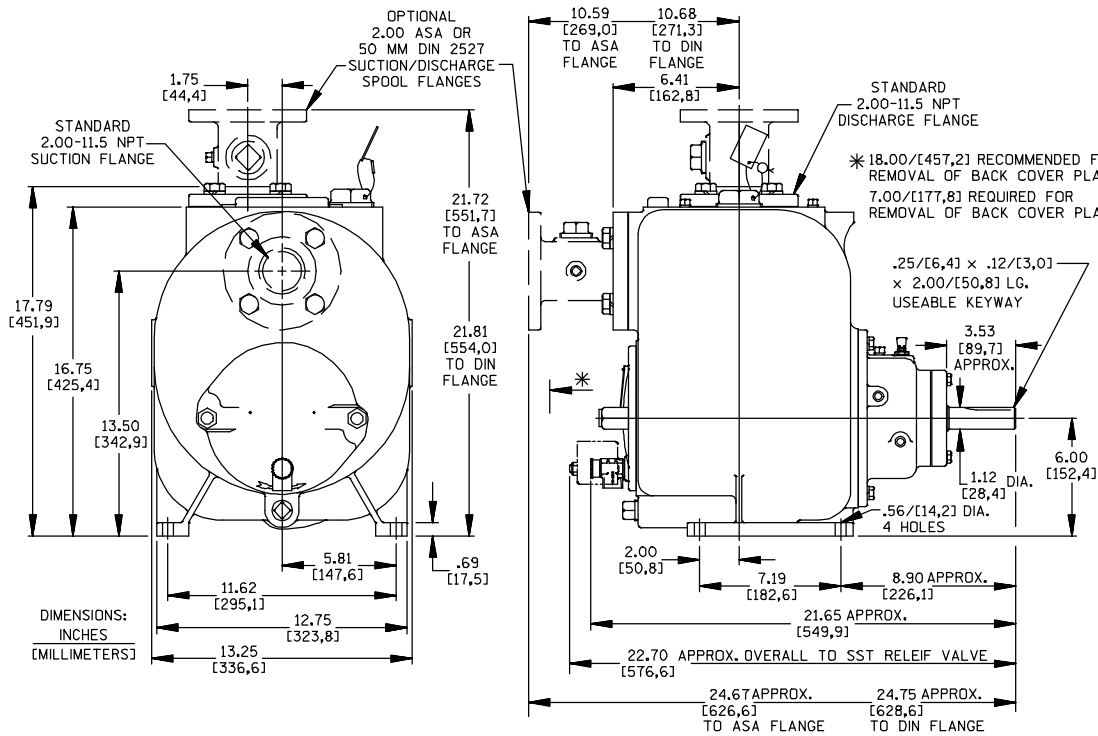

**OPTIONAL ASA OR DIN STANDARD SUCTION & DISCHARGE SPOOL FLANGES AVAILABLE**

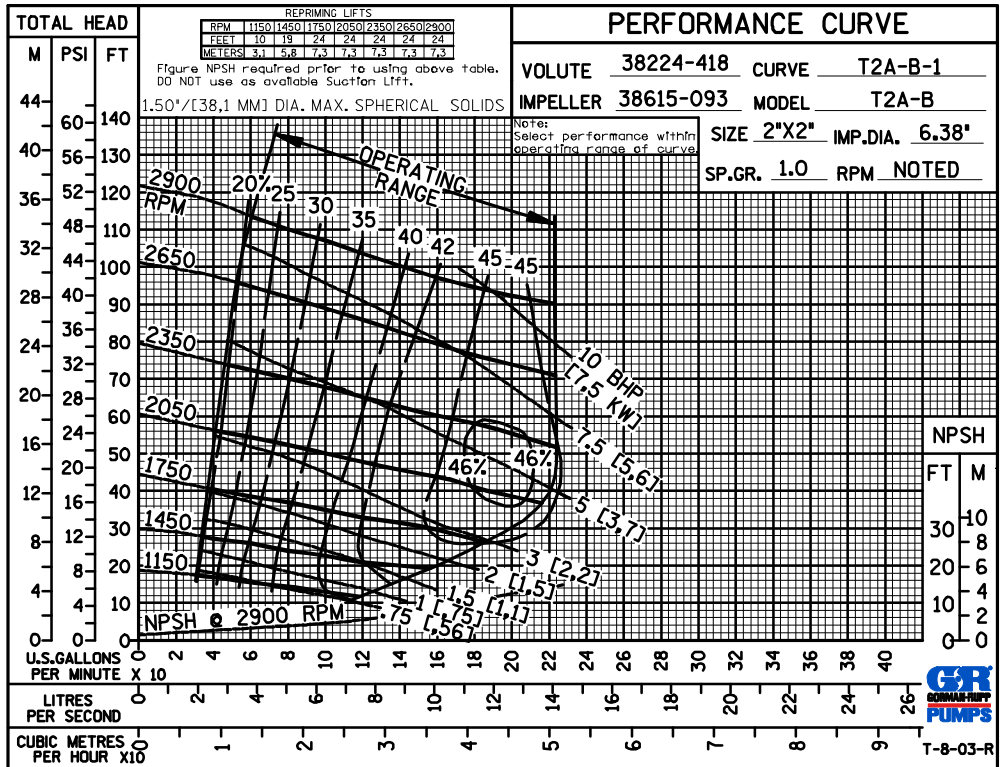

**GORMAN-RUPP PUMPS**

www.grpumps.com

Specifications Subject to Change Without Notice

Printed in U.S.A.

**MULTI-SPEED  
PERFORMANCE  
BASED ON  
WATER  
TRIMMED  
IMPELLER**

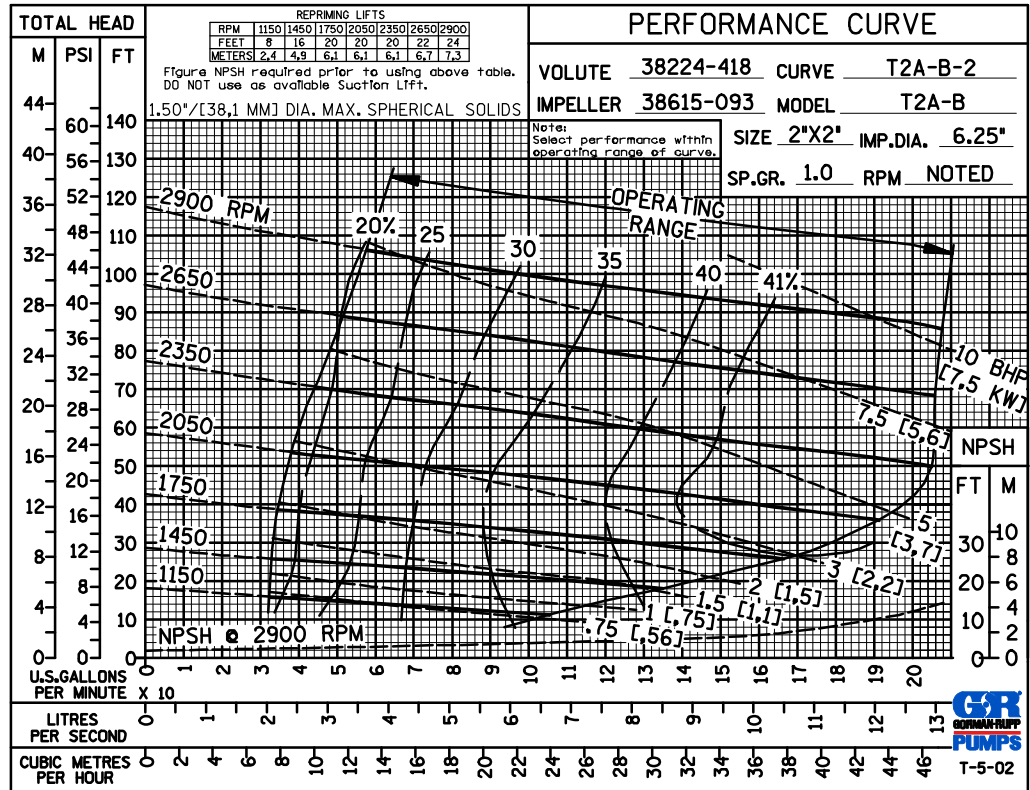

**MULTI-SPEED  
PERFORMANCE  
BASED ON  
WATER  
TRIMMED  
IMPELLER**

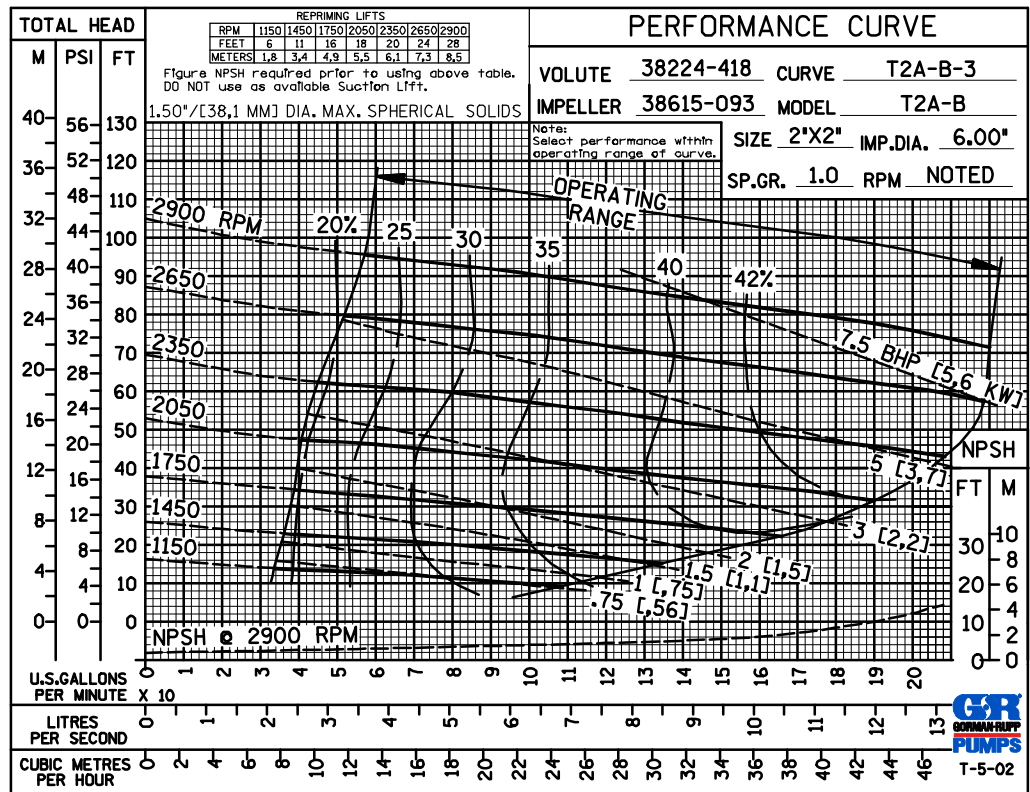

**GORMAN-RUPP PUMPS**

www.grpumps.com

Specifications Subject to Change Without Notice

Printed in U.S.A.

**MULTI-SPEED  
PERFORMANCE  
BASED ON  
WATER  
TRIMMED  
IMPELLER**

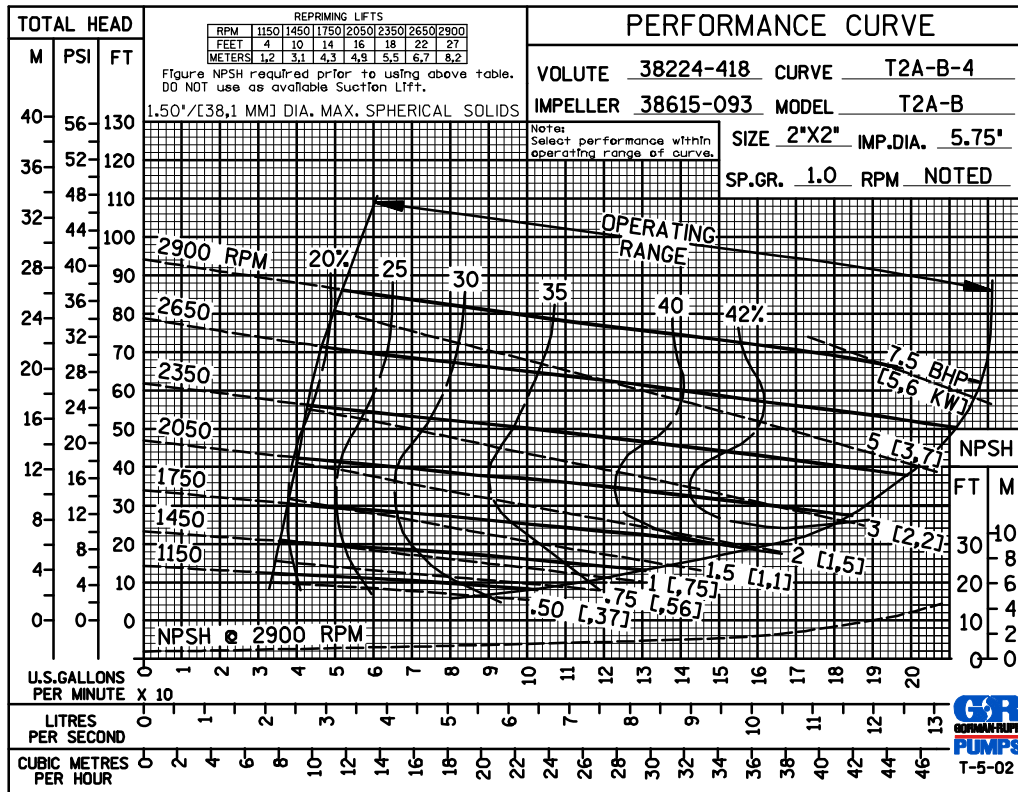

**MULTI-SPEED  
PERFORMANCE  
BASED ON  
WATER  
TRIMMED  
IMPELLER**

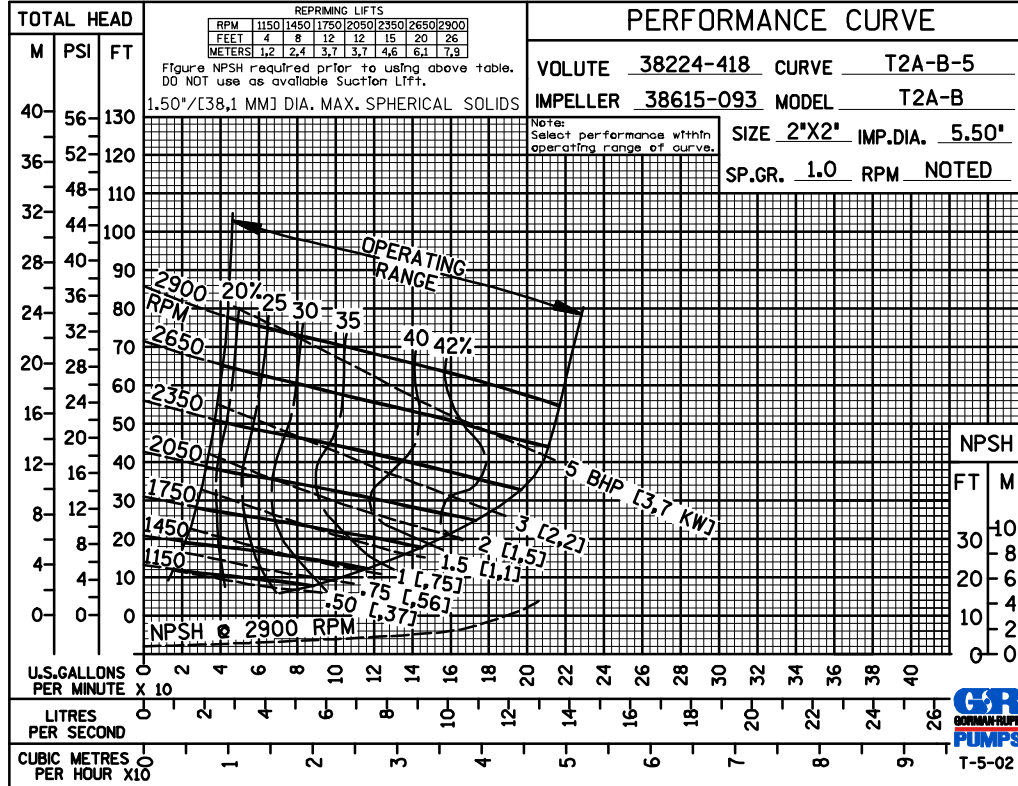

GORMAN-RUPP PUMPS

www.grpumps.com

Specifications Subject to Change Without Notice

Printed in U.S.A.

PERFORMANCE  
BASED ON  
WATER  
TRIMMED  
IMPELLER

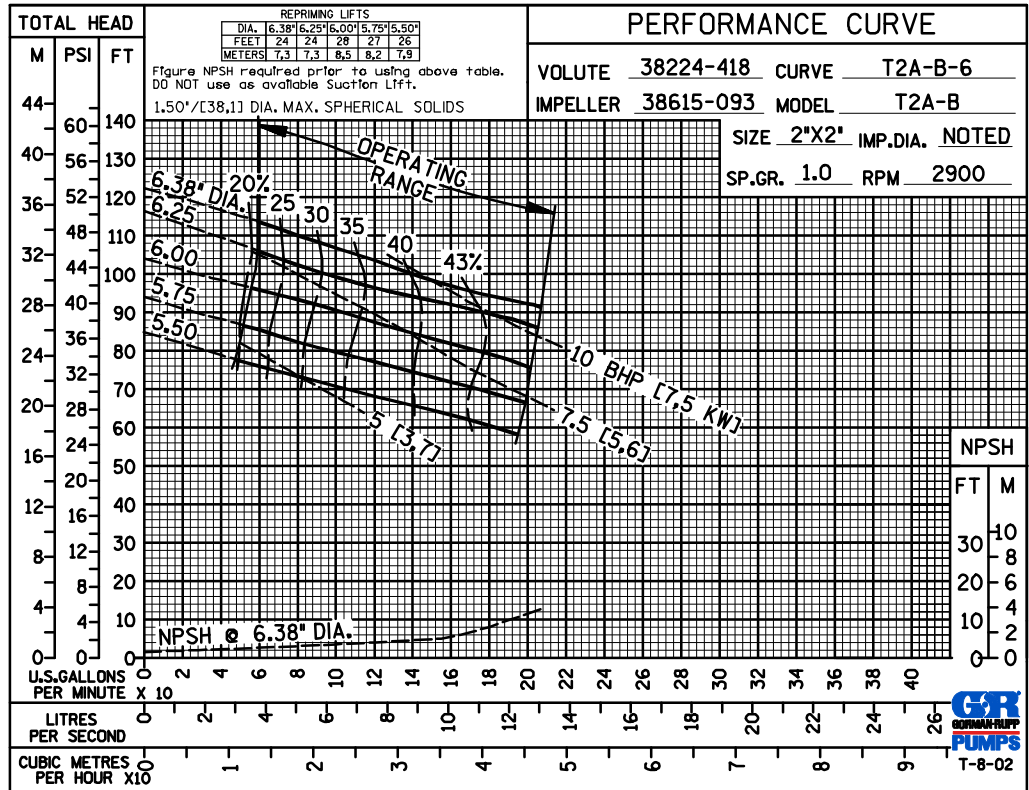

PERFORMANCE  
BASED ON  
WATER  
TRIMMED  
IMPELLER

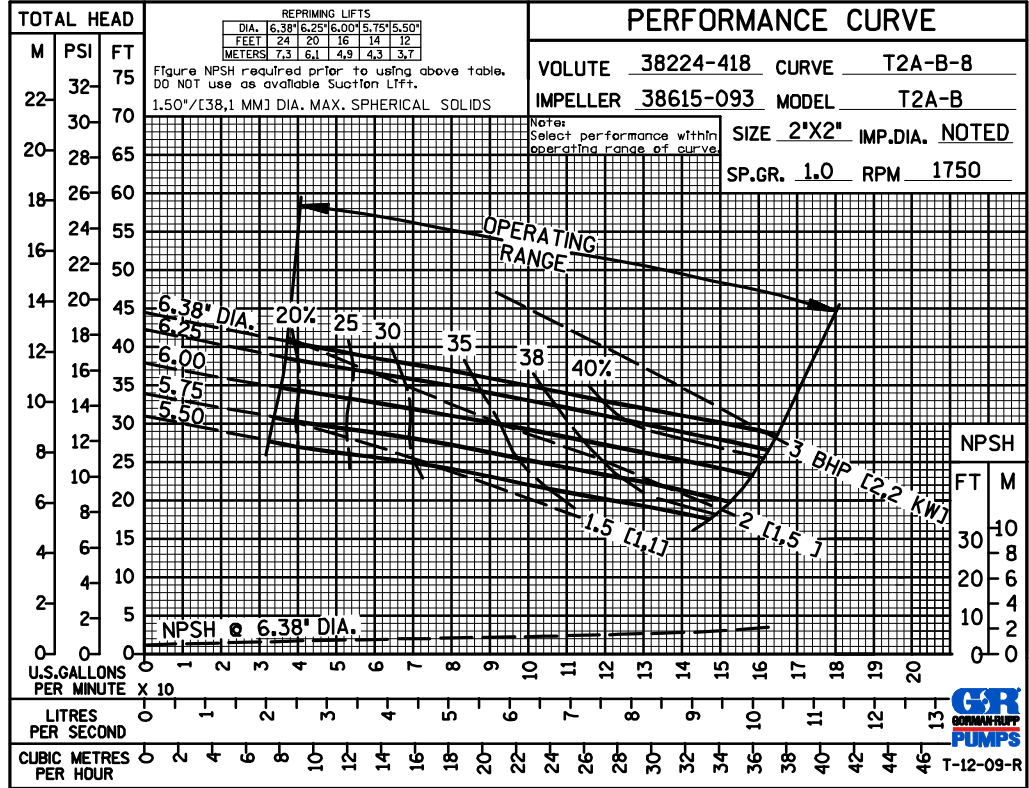

GORMAN-RUPP PUMPS

www.grpumps.com

Specifications Subject to Change Without Notice

Printed in U.S.A.

PERFORMANCE  
BASED ON  
WATER  
TRIMMED  
IMPELLER

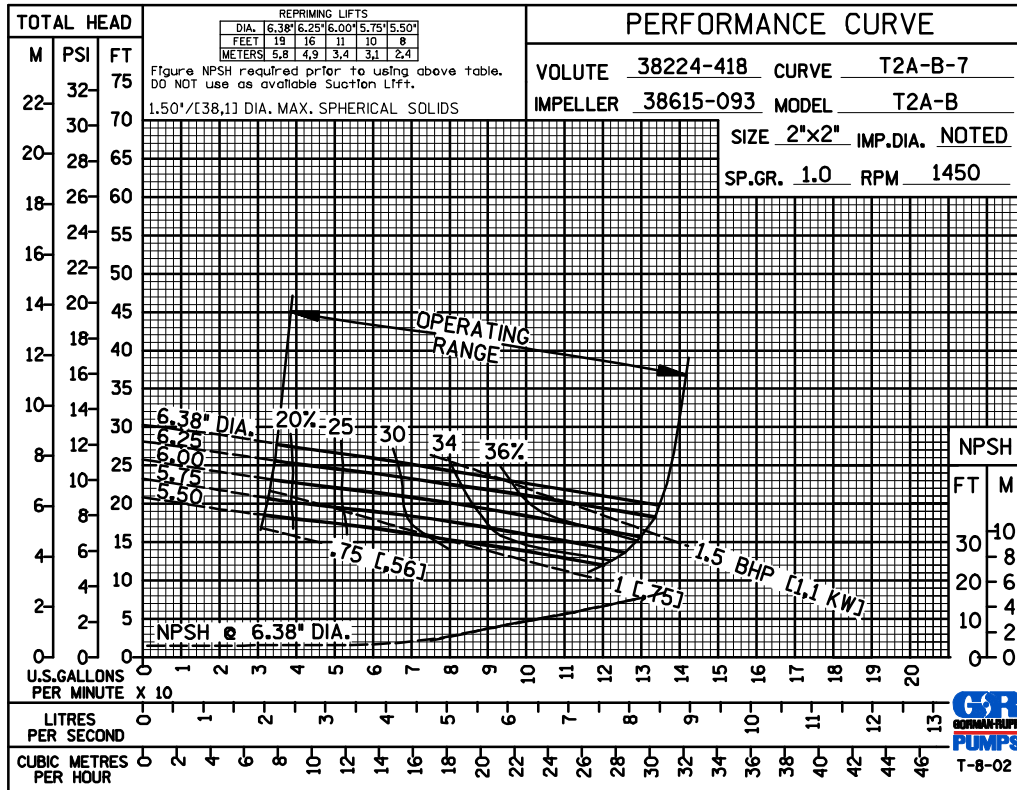

PERFORMANCE  
BASED ON  
WATER  
TRIMMED  
IMPELLER

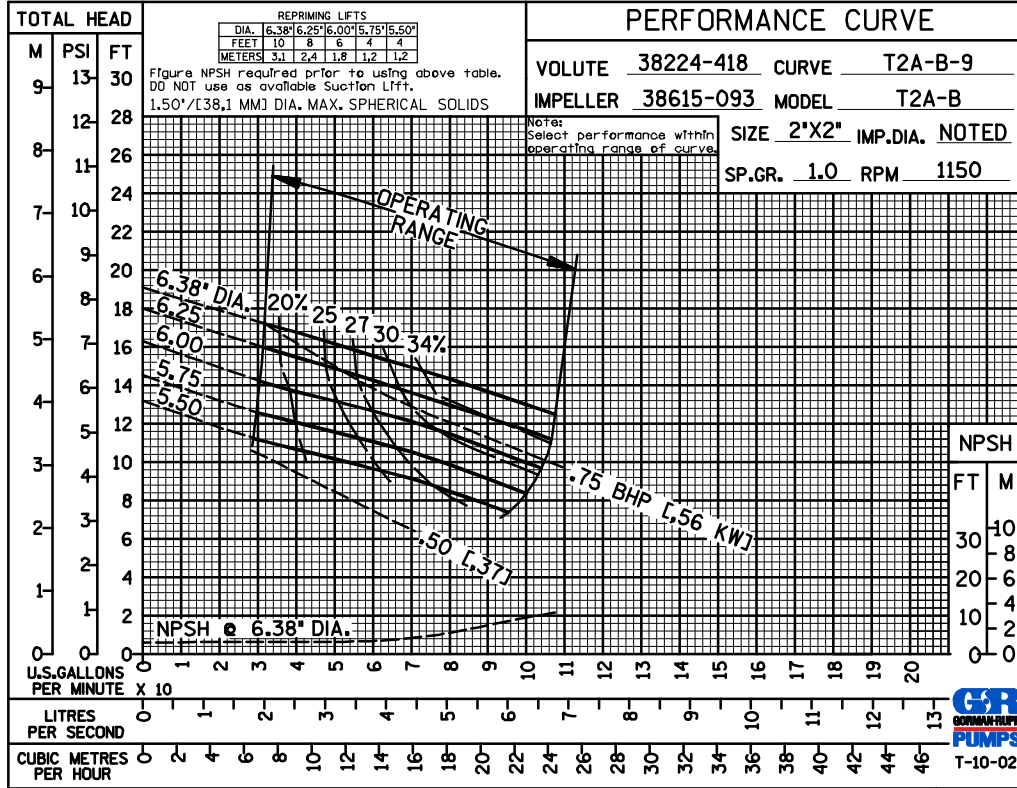

GORMAN-RUPP PUMPS

www.grpumps.com

Specifications Subject to Change Without Notice

Printed in U.S.A.

PERFORMANCE  
BASED ON  
WATER  
PUMPS IN  
PARALLEL

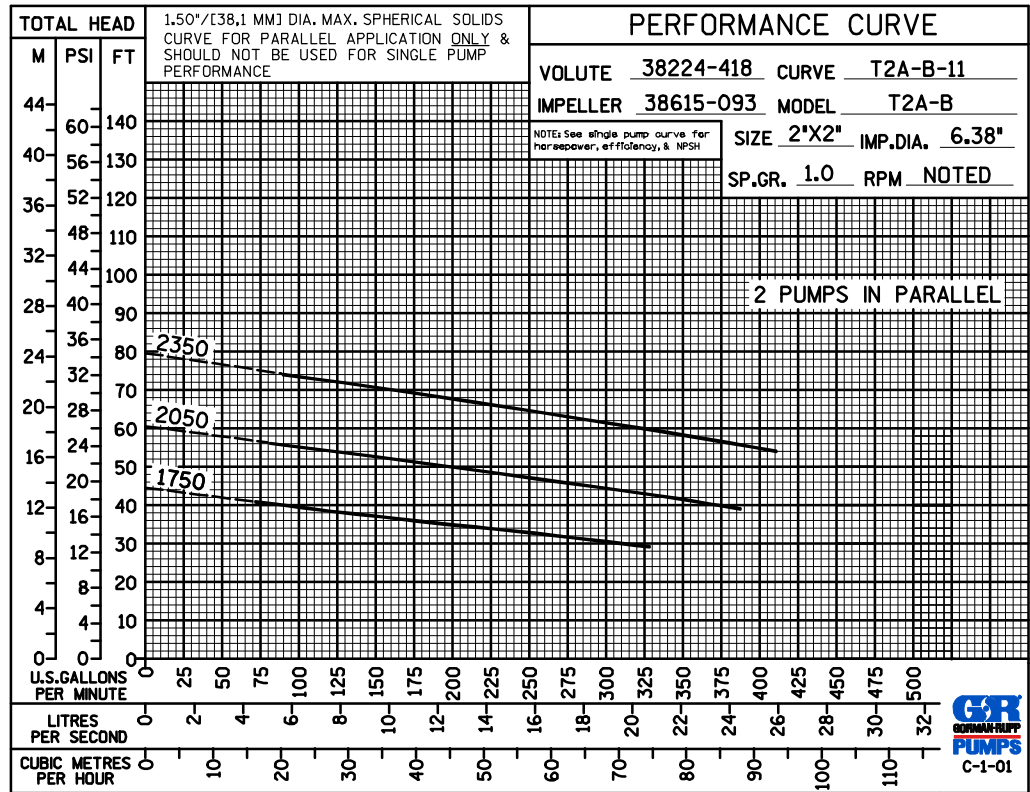

PERFORMANCE  
BASED ON  
WATER  
PUMPS IN  
SERIES

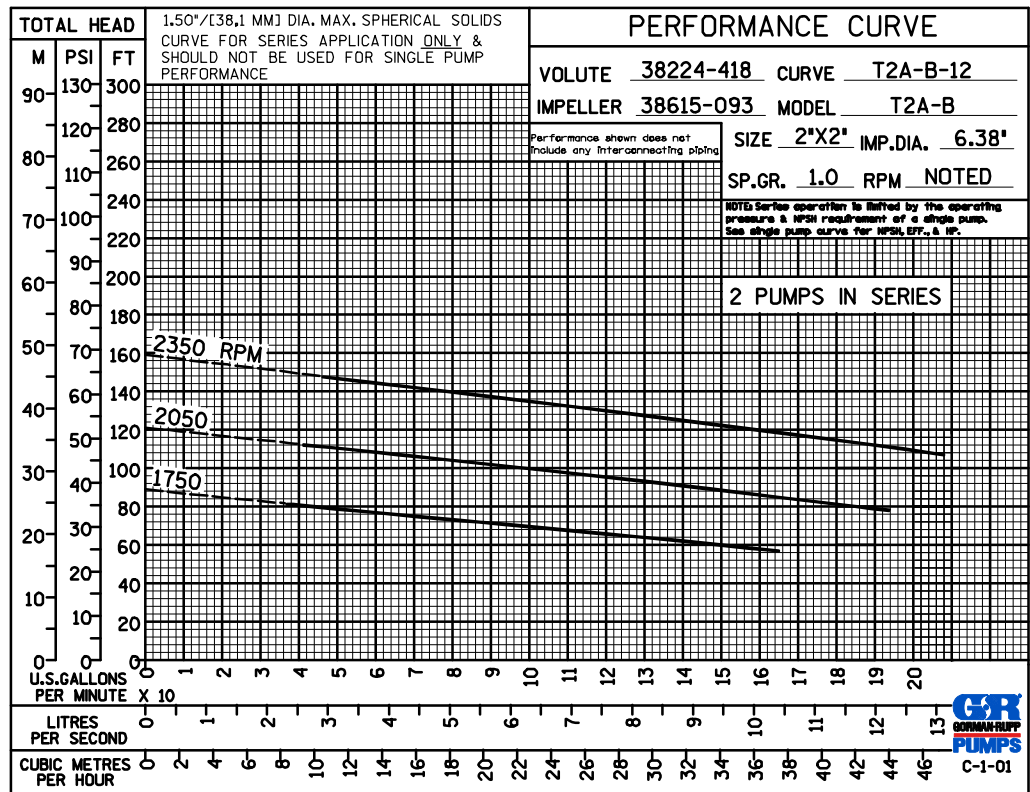

GORMAN-RUPP PUMPS

www.grpumps.com

Specifications Subject to Change Without Notice

Printed in U.S.A.