

**INSTALLATION, OPERATION,  
AND MAINTENANCE MANUAL**  
WITH PARTS LIST



**S SERIES  
SUBMERSIBLE PUMP**

MODEL
<b>S2B65-E2 230/1</b>

**GORMAN-RUPP PUMPS**

[www.grpumps.com](http://www.grpumps.com)

Register your new  
Gorman-Rupp pump online at  
**[www.grpumps.com](http://www.grpumps.com)**

Valid serial number and e-mail address required.

**RECORD YOUR PUMP MODEL AND SERIAL NUMBER**

Please record your pump model and serial number in the spaces provided below. Your Gorman-Rupp distributor needs this information when you require parts or service.

Pump Model: \_\_\_\_\_

Serial Number: \_\_\_\_\_

# TABLE OF CONTENTS

<b>INTRODUCTION</b> .....	<b>PAGE I – 1</b>
<b>SAFETY - SECTION A</b> .....	<b>PAGE A – 1</b>
<b>INSTALLATION – SECTION B</b> .....	<b>PAGE B – 1</b>
GENERAL INFORMATION .....	PAGE B – 1
Pump Model Designation .....	PAGE B – 1
PREINSTALLATION INSPECTION .....	PAGE B – 1
PUMP SEAL .....	PAGE B – 1
LUBRICATION .....	PAGE B – 1
PUMP INSTALLATION .....	PAGE B – 2
Pump Motor Specifications .....	PAGE B – 2
Pump Dimensions .....	PAGE B – 2
Lifting .....	PAGE B – 3
Positioning of Pump .....	PAGE B – 3
Piping .....	PAGE B – 4
ELECTRICAL CONNECTIONS .....	PAGE B – 4
Control Box Installation .....	PAGE B – 5
Dual Voltage Usage .....	PAGE B – 5
Field Wiring Connections (Incoming Power) .....	PAGE B – 5
Grounding Methods .....	PAGE B – 6
Pump Power Cable Connections .....	PAGE B – 7
Control Box Specifications .....	PAGE B – 8
Motor Cable Grounding Test .....	PAGE B – 8
Liquid Level Devices .....	PAGE B – 8
WIRING DIAGRAMS .....	PAGE B – 10
<b>OPERATION – SECTION C</b> .....	<b>PAGE C – 1</b>
GENERAL INFORMATION .....	PAGE C – 1
Pump Performance .....	PAGE C – 1
Control Box .....	PAGE C – 1
PUMP OPERATION .....	PAGE C – 1
Liquid Temperature And Overheating .....	PAGE C – 1
Impeller Rotation .....	PAGE C – 2
STARTING, STOPPING, AND OPERATIONAL CHECKS .....	PAGE C – 3
Starting .....	PAGE C – 3
Stopping .....	PAGE C – 3
Operational Checks .....	PAGE C – 3
COLD WEATHER PRESERVATION .....	PAGE C – 4
LUBRICATION .....	PAGE C – 4
Draining Oil .....	PAGE C – 5
Condition of Oil .....	PAGE C – 5
Adding Oil .....	PAGE C – 5
<b>TROUBLESHOOTING – SECTION D</b> .....	<b>PAGE D – 1</b>
PREVENTIVE MAINTENANCE .....	PAGE D – 3

**TABLE OF CONTENTS**  
**(continued)**

<b>PUMP MAINTENANCE AND REPAIR - SECTION E .....</b>	<b>PAGE E – 1</b>
STANDARD PERFORMANCE CURVE .....	PAGE E – 1
PARTS LISTS:	
Pump Model .....	PAGE E – 3
Terminal Housing and Cable Assembly .....	PAGE E – 5
PUMP END DISASSEMBLY .....	PAGE E – 6
Strainer Removal .....	PAGE E – 7
Draining Oil From Seal Cavity .....	PAGE E – 7
Draining Oil From Motor Cavity .....	PAGE E – 7
Positioning Pump For Disassembly .....	PAGE E – 7
Suction Casing Removal .....	PAGE E – 7
Impeller Removal .....	PAGE E – 7
Lower Seal Removal .....	PAGE E – 8
Upper Seal Removal .....	PAGE E – 8
PUMP END REASSEMBLY .....	PAGE E – 8
Cleaning and Inspection of Pump Parts .....	PAGE E – 8
Upper Seal Installation .....	PAGE E – 9
Lower Seal Installation .....	PAGE E – 10
Impeller Installation .....	PAGE E – 11
Suction Casing Reassembly .....	PAGE E – 11
Impeller Clearance .....	PAGE E – 11
Strainer Installation .....	PAGE E – 11
MOTOR DISASSEMBLY .....	PAGE E – 12
Terminal Housing and Power Cable Removal and Disassembly .....	PAGE E – 12
Pump Casing And Motor Housing Disassembly .....	PAGE E – 13
Rotor Removal .....	PAGE E – 13
Bearing Removal .....	PAGE E – 13
Stator Removal .....	PAGE E – 14
Relief Valve .....	PAGE E – 14
Hoisting Bail .....	PAGE E – 14
MOTOR REASSEMBLY .....	PAGE E – 14
Stator Installation .....	PAGE E – 15
Bearing Installation .....	PAGE E – 16
Rotor and Installation .....	PAGE E – 16
Terminal Housing and Power Cable Reassembly and Installation .....	PAGE E – 17
Sealing Terminal Housing Connections With Silicone Adhesive .....	PAGE E – 17
Sealing Terminal Plate Connections With Potting Compound .....	PAGE E – 19
Securing And Insulating Motor Leads Inside Motor Housing .....	PAGE E – 20
Terminal Housing Reassembly .....	PAGE E – 20
Terminal Housing Installation .....	PAGE E – 20
FINAL ASSEMBLY .....	PAGE E – 21
VACUUM TESTING .....	PAGE E – 21
LUBRICATION .....	PAGE E – 22
Seal Cavity .....	PAGE E – 22
Motor Housing Cavity .....	PAGE E – 22

## INTRODUCTION

**Thank You** for purchasing a Gorman-Rupp pump. **Read this manual** carefully to learn how to safely install and operate your pump. Failure to do so could result in personal injury or damage to the pump.

This manual will alert personnel to known procedures which require special attention, to those which could damage equipment, and to those which could be dangerous to personnel. However, this manual cannot possibly anticipate and provide detailed precautions for every situation that might occur during maintenance of the unit. Therefore, it is the responsibility of the owner/maintenance personnel to ensure that **only** safe, established maintenance procedures are used, and that any procedures not addressed in this manual are performed **only** after establishing that neither personal safety nor pump integrity are compromised by such practices.

If there are any questions regarding the pump or its application which are not covered in this manual or in other literature accompanying this unit, please contact your Gorman-Rupp distributor, or the Gorman-Rupp Company:

**The Gorman-Rupp Company**  
**P.O. Box 1217**  
**Mansfield, Ohio 44901-1217**  
**Phone: (419) 755-1011**  
 or:  
**Gorman-Rupp of Canada Limited**  
**70 Burwell Road**  
**St. Thomas, Ontario N5P 3R7**  
**Phone: (519) 631-2870**

For information or technical assistance on the power source, contact the power source manufacturer's local dealer or representative.

The following are used to alert maintenance personnel to procedures which require special attention, to those which could damage equipment, and to those which could be dangerous to personnel:



**Immediate hazards which WILL result in severe personal injury or death. These instructions describe the procedure required and the injury which will result from failure to follow the procedure.**



**Hazards or unsafe practices which COULD result in severe personal injury or death. These instructions describe the procedure required and the injury which could result from failure to follow the procedure.**



Hazards or unsafe practices which COULD result in minor personal injury or product or property damage. These instructions describe the requirements and the possible damage which could result from failure to follow the procedure.

### NOTE

*Instructions to aid in installation, operation, and maintenance, or which clarify a procedure.*

## SAFETY – SECTION A

This information applies to the S Series submersible motor driven pumps and control boxes.

Because pump installations are seldom identical, this manual cannot possibly provide detailed instructions and precautions for each specific application. Therefore, it is the owner/installer's responsibility to ensure that applications not addressed in this manual are performed only after establishing that neither operator safety nor pump integrity are compromised by the installation.



Before attempting to open or service the pump:

1. Familiarize yourself with this manual.
2. Lock out incoming power to the control box to ensure that the pump will remain inoperative.
3. Allow the pump to completely cool if overheated.
5. Close the discharge valve (if used).



This pump is not designed to pump volatile, explosive, or flammable materials. Do not attempt to pump any liquids for which you pump is not approved, or which may damage the pump or endanger personnel as a result of pump failure. Consult the factory for specific application data.



Before connecting any cable to the control box, be sure to ground the control box. Refer to the Control Box Manual for the suggested grounding methods.



The pump motor is designed to be operated through the control box furnished with the pump. The control box provides overload protection and power control. Do not connect the pump motor directly to the incoming power lines.



The electrical power used to operate this pump is high enough to cause injury or death. Obtain the services of a qualified electrician to make all electrical connections. Make certain that the pump and enclosure are properly grounded; never use gas pipe as an electrical ground. Be sure that the incoming power matches the voltage and phase of the pump and control before connecting the power source. Do not run the pump if the voltage is not within the limits. If the overload unit is tripped during pump operation, correct the problem before restarting the pump.



The electrical power used to operate this pump is high enough to cause injury or death. Make certain that the control handle on the control box is in the OFF

position and locked out, or that the power supply to the control box has been otherwise cut off and locked out, before attempting to open or service the pump assembly. Tag electrical circuits to prevent accidental start-up.



Never attempt to alter the length or repair any power cable with a splice. The pump motor and cable must be completely waterproof. Injury or death may result from alterations.



All electrical connections must be in accordance with The National Electric Code and all local codes. If there is a conflict between the instructions provided and N.E.C. Specifications, N.E.C. Specifications shall take precedence. All electrical equipment supplied with this pump was in conformance with N.E.C. requirements in effect on the date of manufacture. Failure to follow applicable specifications, or substitution of electrical parts not supplied or approved by the manufacturer, can result in severe injury or death and void warranty.



Death or serious personal injury and damage to the pump or components can occur if proper lifting procedures are not observed. Make certain that hoists, chains, slings or cables are in good working condition and of sufficient capacity and that they are positioned so that loads will be balanced

and the pump or components will not be damaged when lifting. Do not attempt to lift this pump by the motor or control cables, or the piping. Attach proper lifting equipment to the lifting bail fitted on the pump. Lift the pump or component only as high as necessary and keep personnel away from suspended objects.



After the pump has been installed, make certain that the pump and all piping or hose connections are secure before operation.



Obtain the services of a qualified electrician to troubleshoot, test and/or service the electrical components of this pump.



Approach the pump cautiously after it has been running. Although the motor is cooled by the liquid being pumped, normal operating temperatures can be high enough to cause burns. The temperature will be especially high if operated against a closed discharge valve. Never operate against a closed discharge valve for long periods of time.



Do not remove plates, covers, gauges, pipe plugs, or fittings from an overheated pump. Vapor pressure within the pump can cause parts being disengaged to be ejected with great force. Al-

low the pump to completely cool before servicing.



Do not attempt to lift the pump by the motor power cable or the piping. Attach proper lifting equipment to the lifting device fitted to the pump. If chains or cable are wrapped around the pump to

lift it, make certain that they are positioned so as not to damage the pump, and so that the load will be balanced.

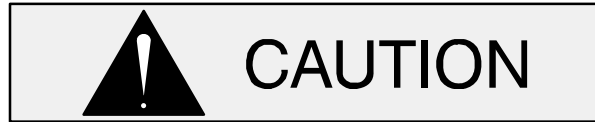

Pumps and related equipment must be installed and operated according to all national, local and industry standards.

## INSTALLATION – SECTION B

### GENERAL INFORMATION

#### Review all SAFETY information in Section A.

Since pump installations are seldom identical, this section is intended only to summarize general recommendations and practices required to inspect, position, and arrange the pump and piping. If there are any questions concerning your specific installation, contact your Gorman-Rupp distributor or the Gorman-Rupp Company.

Liquid level devices are available from Gorman-Rupp as optional equipment. For information on installing and operating these items, refer to the literature accompanying them.

#### Pump Model Designation

Following is a description of the model numbering system for S Series pumps. These submersible pumps are available in a range of sizes. Refer to the following chart to identify the size for your specific pump model.

Pump Model						
S	3	C	1	–	E 6.2	230/3
Series	Discharge Size	Pump Hydraulics	Pump Construction		H.P. (If Shown)	Voltage/Phase

### PREINSTALLATION INSPECTION

The pump assembly was inspected and tested before shipment from the factory. Before installation, check for damage which may have occurred during shipment. Check as follows:

- Inspect the pump assembly for cracks, dents, damaged threads, and other obvious damage.
- Check for loose attaching hardware. Since gaskets tend to shrink after drying, check for loose hardware at the mating surfaces.
- Inspect the power cable for cuts or any other obvious damage.
- Check that amperes, phase, voltage and hertz indicated on the name plate match the

ratings on the control box and incoming power.

- Carefully read all tags, decals, and markings on the pump, and perform all duties indicated.
- Check for oil leaks. If there is any indication of an oil leak, see **LUBRICATION** at the end of this manual.

### PUMP SEAL

S Series pumps utilize one of the following sealing methods.

- There are two shaft seals in the pump. The lower seal prevents liquid from entering the intermediate cavity at the impeller end. The upper seal prevents oil leakage from the motor housing cavity and acts as back-up protection in the event of lower seal failure.
- The pump is equipped with one double-faced seal assembly. It is designed to prevent the liquid being pumped from entering the intermediate cavity at the impeller end, and to prevent moisture from entering the motor housing cavity at the motor end.

Regardless of which sealing method is used, the seal is lubricated by premium quality submersible pump oil.

### LUBRICATION

S series pumps are lubricated in one of the following methods.

- Some pumps utilize two lubrication cavities. The motor housing cavity provides lubrication to the motor assembly and bearings, while the intermediate cavity provides lubrication to the pump seal.
- Some pumps utilize one lubrication cavity, located just behind the seal plate. It is filled with premium quality submersible pump oil which lubricates the pump seal. The motor operates in and is cooled by air, therefore it requires no lubrication.

All S Series pumps are fully lubricated when shipped from the factory. However, lubrication levels **must be checked** before installing the pump

(see **LUBRICATION** in the **MAINTENANCE AND REPAIR MANUAL**). An additional quart (0,9 liter) of oil is provided to “top off” the oil level in the pump motor cavity, if so required. If the oil level is abnormally low, determine the cause before putting the pump into service.

Due to differences in pump design, the quantity of oil and manner in which oil is to be added to the seal cavity varies between pump models. Refer to

Table B-2 for oil capacities and positions for filling the seal cavity in each pump. Motor cavities requiring lubrication should always be positioned vertically for filling. Refer to **LUBRICATION**, Section C for lubrication specifications and intervals.

**PUMP INSTALLATION**

**Pump Motor Specifications**

See following tables for pump specifications.

**Table B-1. Pump Specifications**

Model	Voltage/Phase	Dual Voltage	Pump HP/KW	Motor Speed (RPM)	Full Load Amperes	No Load Amperes	Locked Rotor Amperes	Discharge Size (NPT)
S2B	230/1	NO	2 HP	3450	12	4.2	38	2 INCH

**Table B-2. Additional Specifications**

Pump Model	Voltage/Phase	Approximate Weight – Lbs. (kg)		Oil Capacity Ounces (Liters)		Seal Cavity Filling Position (H)orizontal (V)ertical *(A)ngle
		Pump	50 Ft. Cable	Seal Cavity	Motor Cavity	
S2B	230/1	56 (25)	12 (5)	8 (0,2)	32 (1)	V

\* Position Pumps at Approximately 30° off Vertical

**Pump Dimensions**

For the approximate physical dimensions of your pump, refer to the pump specification data sheet or contact your Gorman-Rupp distributor or the Gorman-Rupp Company.



**When installing or servicing the pump or controls, follow all requirements for the installation of wiring or electrical equipment as outlined in the National Electric Code. Follow all safety require-**

**ments. Failure to observe these requirements could result in injury or death to personnel.**



**Do not** allow the free end of the power cable to enter the liquid being pumped. The free end of the cable **must** be kept dry to prevent liquid from wicking through the cable and into the motor.

**NOTE**

*Refer to the performance curve in the Parts List*

Manual when determining the most efficient piping installation. **The recommended maximum submergence depth is 65 feet.**

### Lifting

Pump unit weights will vary depending on the mounting and drive provided. Check the shipping tag on the unit packaging for the actual weight, and use lifting equipment with appropriate capacity. Drain the pump and remove all customer-installed equipment such as suction and discharge hoses or piping before attempting to lift existing, installed units.

Refer to Table B-2 for the approximate maximum weight for each pump.



**Death or serious personal injury and damage to the pump or components can occur if proper lifting procedures are not observed. Make certain that hoists, chains, slings or cables are in good working condition and of sufficient capacity and that they are positioned so that loads will be balanced and the pump or components will not be damaged when lifting. Do not attempt to lift this pump by the motor or control cables, or the piping. Attach proper lifting equipment to the lifting bail fitted on the pump. Lift the pump or component only as high as necessary and keep personnel away from suspended objects.**



Use **Only Genuine Gorman-Rupp** replacement parts. Failure to do so may create a hazard and damage the pump or di-

minish optimal pump performance. Any such hazard, damage or diminished performance is not covered by the warranty.

### NOTE

*When appropriate recycling facilities are available, the user should recycle components and fluids when doing any routine maintenance / repairs and also at the end of the pump's useful life. All other components and fluids shall be disposed of according to all applicable codes and regulations.*

### Positioning the Pump

### NOTE

*Before installing and operating the pump, check the direction of impeller rotation to ensure that the pump is properly wired at the control box. See **IMPELLER ROTATION**, Section C.*

The pump is designed to operate fully or partially submerged. The rotating parts are oil lubricated, and the motor is cooled by a constant flow of liquid or air discharged through internal passages.

As a safeguard against rupture or explosion due to heat, models equipped with oil-lubricated motors are fitted with a pressure relief valve which will open if vapor pressure within the pump motor reaches a critical point.

The pump will operate if positioned on its side, but this is not recommended because the motor torque could cause the pump to roll during operation.

The pump should be independently secured and supported by the lifting device fitted on the pump. If the application involves a lot of debris, protect the pump from excessive wear and clogging by suspending it in a perforated barrel or culvert pipe. If the bottom is heavily sludge-covered, rest the pump on support blocks or suspend it from a raft or similar device near the surface of the liquid. See Figure B-1 for typical pump installations.

All liquid entering the pump must pass through a strainer screen. Any spherical solids which pass through the screen will pass through the pump.

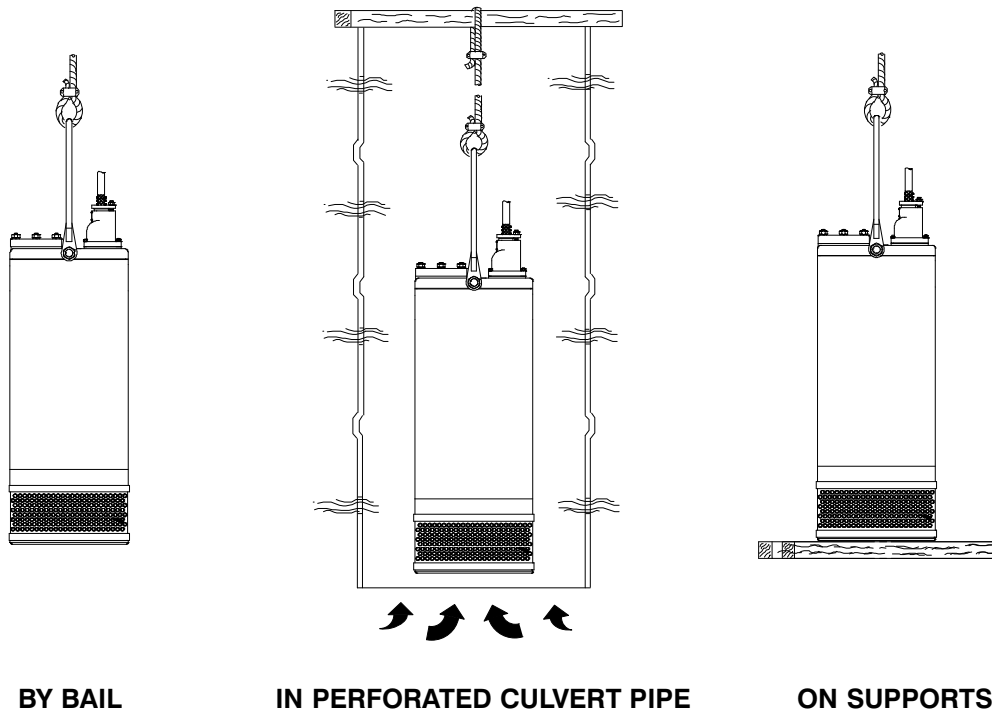

Figure B-1 Typical Pump Installations

### Piping

No suction piping is required in a standard installation.

S Series pumps are provided with a suction strainer to prevent large solids from clogging the impeller. On some models the strainer can be removed and the pump suction “staged” to the discharge of another pump, allowing one pump to feed the other on high discharge head applications.

To determine the size of the discharge connection, see **Table B-1, Pump Specifications**. Either hose or rigid pipe may be used. To facilitate mobility and maintenance, it is recommended that the discharge line be fitted with a quick disconnect fitting near the pump. The discharge line must be independently supported to avoid strain and vibration on the pump.

Either hose or rigid pipe may be used to make discharge connections. For maximum pumping capacity, keep the line as short and straight as possible.

Elbows and fittings used in discharge lines increase friction loss, minimize their use.

It is recommended that a check valve or throttling valve be installed in the discharge line to control siphoning or back flow when the pump is shut off.

### ELECTRICAL CONNECTIONS



**WARNING!**

**Install and operate this pump in accordance with the National Electrical Code and all local codes. Have a qualified electrician perform all checks and connections in this section.**

**Never attempt to alter the length of the pump motor cable or to repair it with a splice. The power cable and pump motor must be kept completely waterproof. Serious damage to the pump and injury**

or death to personnel can result from any alteration to the cable.

#### Control Box Installation



The pump is designed to be operated through the control box furnished with the pump. The control box provides overload protection and power control. Do not connect the pump motor directly to the incoming power lines.

The control box is a rainproof enclosure with a padlockable front cover. The enclosure is not designed to be watertight, and should not be submerged. Refer to the control box manual for enclosure dimensions and parts.

Secure the control vertically on a level surface, above flood level. The box should be easily accessible to the operator, and located close enough to the pump to avoid excessive voltage drop due to cable length (see **Pump Power Cable Connection**). After the box is installed, make certain the front cover latches properly.



Failure to mount the control box vertically on a level surface may affect operation of the pump controls.

#### Dual Voltage Usage

Some pumps are powered by a dual-voltage motor for utilization with high or low voltage. The motor was originally wired and shipped from the factory for use with the voltage indicated as “Factory Wired” on the pump’s name plate. The name plate also indicates the dual voltage pertaining to this motor. If the alternate voltage must be utilized, control box modifications and/or certain wiring changes are required.

The control box assembly provided with this pump has been designed to accommodate **only** the voltage indicated on the front of the box. This voltage coincides with the “Factory Wired” voltage of the

motor. If the alternate voltage is utilized, the control box must be replaced with another box designed for the appropriate voltage. Alternate voltage control boxes are shown in the Parts List Manual under Pump Options.



Dual voltage pumps are wired at the factory only for the voltage shown on the name plate. Make certain that the control box voltage matches the pump voltage before using. If the pump voltage is changed, the pump name plate must be changed and a new control box must be installed. Do not run the pump if the voltages do not match; otherwise, the pump warranty will be negated, and damage to the pump, and injury or death to personnel can result.

The motor wiring **must also** be changed before utilizing alternate voltage. For detailed instructions on disassembly and reassembly of the terminal housing, see **Terminal Housing and Power Cable Disassembly** and **Terminal Housing and Power Cable Reassembly** in the Maintenance And Repair manual. Change the motor leads as indicated on the wiring diagram plate affixed to the side of the terminal housing (see Figure B-2). **Be sure** to tag the revised voltage on the pump.

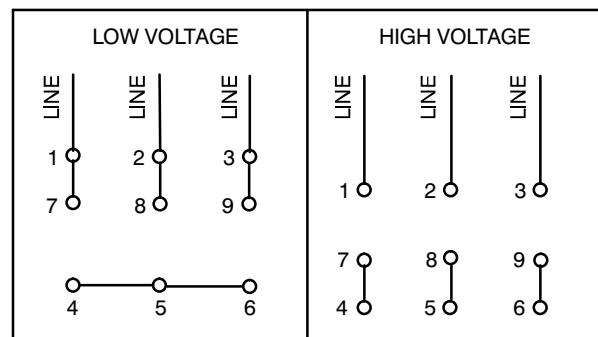

#### Field Wiring Connections (Incoming Power)



The electrical power used to operate

this pump is high enough to cause injury or death. Obtain the services of a qualified electrician to make all electrical connections. Make certain that the pump and enclosure are properly grounded; **never** use gas pipe as an electrical ground. Be sure that the incoming power matches the voltage and phase of the pump and control before connecting the power source. Do not run the pump if the voltage is not within the limits.



Do not connect the pump motor directly to the incoming power lines. The pump motor is designed to operate through a Gorman-Rupp approved control box which provides overload protection and power control; otherwise, the pump warranty will be voided. Make certain that the pump and control box are properly grounded. Install and operate the control box in accordance with the National Electric Code and all local codes. Failure to follow these could result in injury or death to personnel.

Field wiring is **not** provided with the pump, and must be supplied by the user. The field wiring must be of the proper size and type to ensure an adequate voltage supply to the pump. Voltage available **at the motor** must be within the range indicated in Table B-3.

To calculate the voltage available at the motor, proceed as follows:

- a. Measure the voltage across the incoming lines (1 & 2 for single phase, 1 & 2, 2 & 3, and 1 & 3 for three phase) **while the pump is operating at full capacity**. Refer to the literature supplied with the control box for power supply connections.

- b. Next, subtract the motor cable voltage drop (see Table 4, **Pump Power Cable Specifications**).
- c. Do not continue to operate the pump if this voltage is not within the recommended limits. Obtain the services of a qualified electrician to determine the correct field wiring size and other details to ensure an adequate voltage supply to the pump.

Table B-3. Pump Voltage Requirements

NOMINAL VOLTAGE	PHASE	MINIMUM VOLTAGE	MAXIMUM VOLTAGE
115	1	110	120
230	1	220	240
230	3	210	250
460	3	420	500
575	3	520	630
380	3	345	415

Make certain all connections are tight and that cable entry points are rainproof. Support the cable weight, if required, to prevent excessive strain on cable clamps and cable.

#### Grounding Methods

Electrically ground the installation before connecting the field wiring to the control box. Install a grounding terminal to the enclosure and connect it to a properly embedded electrode.

The material used for the electrode **must** be an excellent conductor of electricity, such as copper. If iron or steel is used, it must be galvanized or otherwise metal plated to resist corrosion. **Do not** coat the electrode with any material of poor conductivity, such as paint or plastic.

The electrode must conform to the recommendations of N.E.C. ARTICLE 250. Follow all installation requirements of the N.E.C., and all applicable codes. See Figure B-3 for some suggested grounding methods.

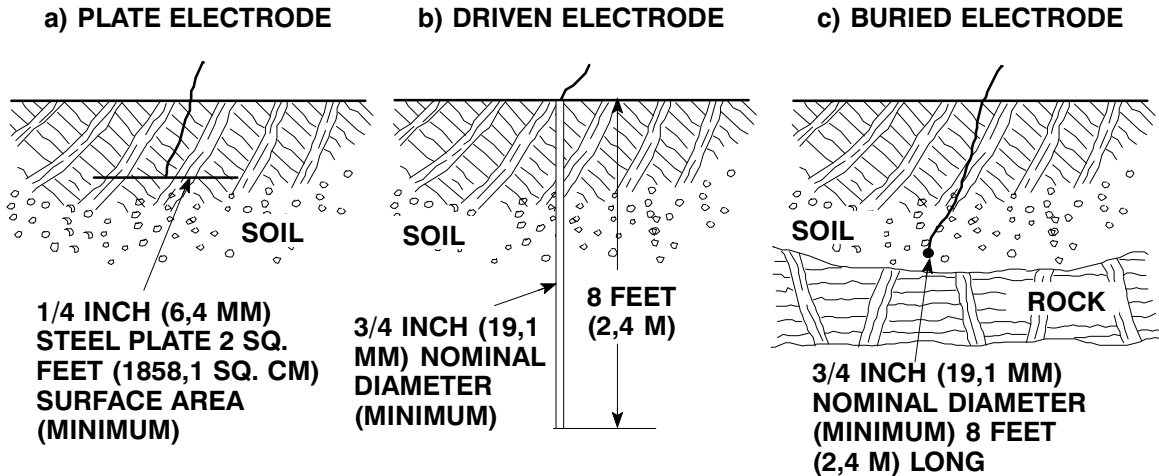

Figure B-3. Suggested Grounding Methods

- Plate Electrode:** An iron or steel plate, 1/4 inch (6,4 mm) thick, completely impeded in the ground. The plate must present a surface area of at least 2 square feet (1858,1 sq. cm.).
- Driven Electrode:** A rod or pipe, 3/4 inch (19,1 mm) in diameter minimum, 8 feet (2,4 m) long, completely driven into the ground.
- Buried electrode:** If rock or stone prevents embedding the full 8 foot (2,4 m) length of the ground rod, bury it horizontally in a trench.

Space the ground rod or plates at least 6 feet (1,8) from any other electrode or ground rod, such as those used for signal circuits, radio grounds, lightning rods, etc.

The earth surrounding the ground rod or plate **must** contain enough moisture to make a good electrical connection. In dry or sandy areas, pour water around the rod, or consult qualified personnel to devise a method of improving the connections.



The electrical power used to operate this pump is high enough to cause injury or death. Make certain that the control box is properly grounded after installation.

Refer to the literature accompanying the control box for field wiring connections.

#### Pump Power Cable Connections



The electrical power used to operate this pump is high enough to cause injury or death. Obtain the services of a qualified electrician to make all electrical connections. **Make certain that incoming power to the control box is in the OFF position and locked out, or that the power supply to the control box has been otherwise cut off and locked out, before connecting power or accessory cables.**

The pump is provided with a 50 ft. (15,2 m) power cable (see Table B-4 for standard power cable specifications). If a longer cable is required, an optional cable assembly **must** be ordered from the factory. Splicing of the power cable is **not** recommended by the Gorman-Rupp Company due to safety and warranty considerations.



Never attempt to alter the length or repair any power cable with a splice. The

**pump motor and cable must be completely waterproof. Injury or death may result from alternations.**

**Table B-4. Pump Power Cable Specifications**

Pump Model	Voltage/Phase	A.W.G Cable Size	Cable O.D. Inches (mm)	Conductor Dia. Inches (mm)	Amp Rating (See Note Below)	Cable Type	DC Resistance (ohms) at 25°C (77°F) per 1000 ft. (305 m)	Voltage Drop per 100 ft. (30,5m) at Max. Load
S2B	230/1	14	0.61(14,5)	.075(1,9)	16.38**	◆ SO	2.73	6.55

**NOTE: \*** Amp Rating at 30°C (86°F)  
**\*\*** Amp Rating at 40°C (104°F)

◆ Canada Use Type SOW Cable

When necessary to change or connect the pump power cable to the control box, make certain the incoming power is **OFF** and **LOCKED OUT**, Make certain the control box is **PROPERLY GROUNDED** and that the electrical data on the control matches the motor name plate data.

Connect the pump power cable to the control box as shown in the wiring diagrams in the control box manual. Use conduit or cable clamps to secure the power cable to the control box. Make certain that all connections are tight and that cable entry points are rainproof.

**NOTE**

*The power cable furnished with the pump includes three electrical conductors (white, red, and black), two grounding conductors (green) and one ground check conductor (yellow). The yellow ground check lead is used in conjunction with customer-supplied ground monitoring equipment. If this equipment is not used, the yellow lead should be used as a ground conductor.*

**Control Box Specifications**



**Any control box used to operate the pump must be approved by the Gorman-Rupp Company for the application.**

**Motor Cable Grounding Test**



**Do not connect the pump control cable to the control box or incoming voltage before verifying the pump ground; otherwise, personnel will be exposed to serious injury or death.**

Using a volt-ohm meter, connect one lead to the motor cable green/yellow ground lead. Connect the other lead to an **uninsulated** point on the pump body. The test circuit should close.

If the test circuit does not close, there is a defect in the cable or motor which must be corrected.

**Control Box Connections**

This pump is shipped completely wired for the voltage shown on the name plate, and is ready for operation through an approved control box.

Ground and wire the control box in accordance with the instructions accompanying it.

**NOTE**

*For reference, internal motor wiring connections are shown in the Maintenance and Repair manual.*

**Liquid Level Devices**

The standard pump is **not** furnished with a means to automatically regulate liquid level. However, the pump may be controlled to perform filling or dewatering.

tering functions by using the following optional sensing device (see Figure B-4):

- **Bulb (Float) Type:** a bulb raises or lowers (floats) with the liquid level, thus activating an enclosed miniature switch.

Other types of liquid level devices may also be used. Consult the factory for the liquid level device best suited for your application.

Models under 6 horsepower require an additional control box to incorporate liquid level controls. For models over 6 horsepower, the circuitry may be prewired as a factory option, or easily added to the standard control box in the field by qualified personnel. The unit is complete except for the remote float switches. For installation and operation, see the detailed instructions included with the optional package.

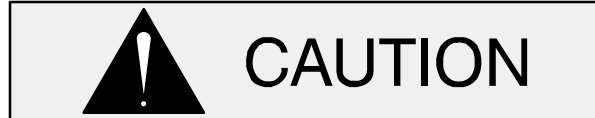

Liquid level devices **must** be positioned far enough apart to allow 10 minutes between starts. If the pump motor cycles more than 6 starts per hour, it will over-heat, resulting in damage to the motor windings or control box components..

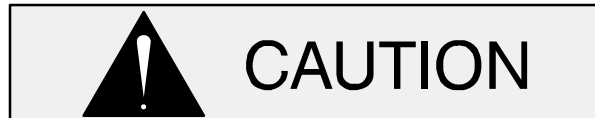

If the pump requires liquid level devices, install the liquid level devices and connect them to the control box in accordance with the instructions accompanying the devices.

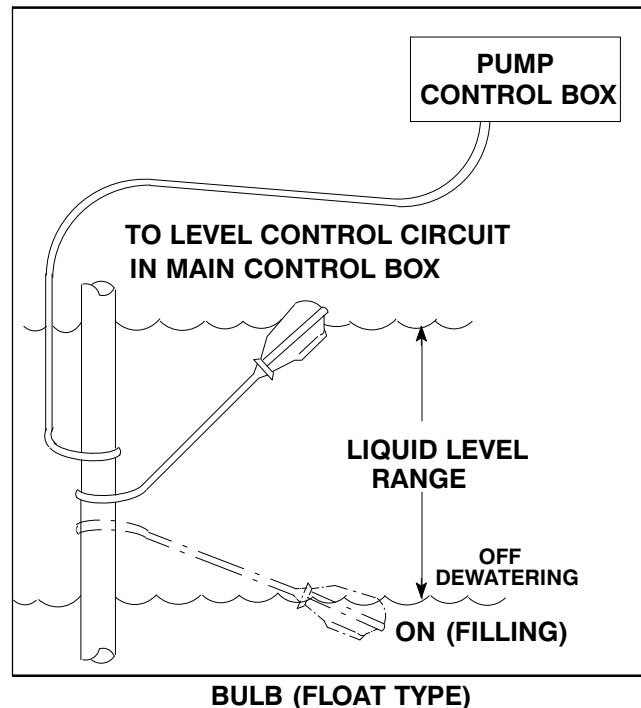

Figure B-4. Liquid Level Device



The internal wiring of the sensing devices are different for filling and dewatering functions. Be sure to follow the instructions in-

cluded with the option before making wiring connections.

#### **WIRING DIAGRAMS**

Refer to the appropriate wiring diagram in the literature accompanying the control box when making electrical connections.

## OPERATION – SECTION C

### GENERAL INFORMATION

Review all SAFETY information in Section A.



This pump is designed to handle most non-volatile, non-flammable liquids. **Do not** attempt to pump any liquids for which your pump is not approved, or which may damage the pump or endanger personnel as a result of pump failure. Consult the factory for specific application data.

Follow the instructions on all tags, labels and decals attached to the pump.

#### Pump Performance



Since operation of the pump motor is dependent upon the quality and performance of the electrical controls, the pump warranty is valid only when controls have been specified or provided by The Gorman-Rupp Company.

Refer to the pump Specification Data Sheet or the accompanying Parts List Manual for the specific performance for your pump.

#### Control Box

A control box is provided to facilitate operation of the pump. It contains controls for starting and stopping the pump, and provides overload protection for the pump motor. The pump control (for models 10 horsepower and up) may be equipped with an optional automatic liquid level sensing device, in which case those circuits are also contained within the control box. Pump models under 6 horsepower

require an additional control box to incorporate liquid level controls.



The pump motor and control box are not designed to be explosion-proof. Do not operate in an explosive atmosphere. Any control box used to operate the pump must be approved by the Gorman-Rupp Company for the application. Improper location of a non-explosion proof control box could result in destruction of equipment, injury or death to personnel.

See the operating instructions furnished with the control box, and with other optional accessories and controls, before attempting to start the pump.

### PUMP OPERATION

Liquid Temperature and Overheating.



**Overheated pumps can cause severe burns and injury. If the pump becomes overheated:**

1. Stop the pump immediately.
2. Lock out the power to the control panel to ensure that the pump will remain inoperative.
3. Allow the pump to completely cool if overheated.
4. Close the discharge valve (if used).
5. Refer to instructions in this manual before restarting the pump.

Overheating can occur if the pump is misapplied; if it is started more than 6 times within one hour; if the temperature of the liquid being pumped ex-

ceeds the temperature for which the pump was designed, if the control box fails to provide overload or thermal protection, or if the pump is operated against a closed discharge valve for an extended period of time.

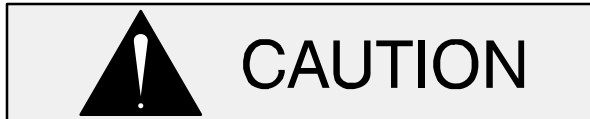

Do not start the pump more than 6 times per hour. If the motor does not cool between starts it will overheat, resulting in damage to the motor windings.

As a safeguard against rupture or explosion due to heat, models equipped with oil-lubricated motors are fitted with a pressure relief valve which will open if vapor pressure within the pump motor reaches a critical point. Always terminate power to the pump and control before investigating pump or control box problems.



**Approach the pump cautiously after it has been running. Although the motor is cooled by the liquid being pumped, normal operating temperatures can be high enough to cause burns. The temperature will be especially high if operated against a closed discharge valve. Never operate against a closed discharge valve for long periods of time.**

If overheating does occur, stop the pump immediately and allow it to cool before servicing it. **Approach any overheated pump cautiously.**



**Overheated pumps can cause severe burns and injuries. If overheating of the pump occurs:**

1. **Stop the pump immediately.**

2. **Ventilate the area.**
3. **Allow the pump to completely cool.**
4. **Check the temperature before servicing.**
5. **Vent the pump slowly and cautiously**
6. **Refer to instructions in this manual before restarting the pump.**

If so equipped, it is recommended that the pressure relief valve assembly be replaced at each overhaul, or any time the pump motor overheats and activates the valve. **Never** replace this valve with a substitute which has not been specified or provided by the Gorman-Rupp Company.

#### Impeller Rotation

Check impeller rotation as follows before operation to ensure that the impeller is rotating in the correct direction.



While checking impeller rotation, secure the pump to prevent the power cable from coiling.

Suspend the pump from the lifting device fitted on the pump. Apply power briefly and note the direction of pump kickback. As viewed from the top, the pump should kick in a **counterclockwise** direction; this will indicate that impeller rotation is correct.

If the pump kicks in a **clockwise** direction, impeller rotation is incorrect. If the pump is powered by a three-phase motor, have a qualified electrician interchange the control box connections of any two pump motor power leads. Re-check pump kickback; it should now be in a counterclockwise direction.

If rotation is incorrect on a single-phase motor, contact the factory before installing the pump.



The electrical power used to operate this pump is high enough to cause injury or death. Make certain that incoming power is off and locked out before interchanging motor leads.

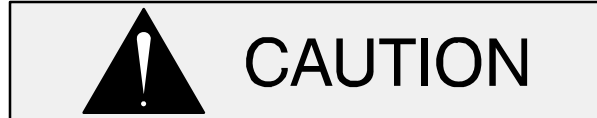

Never start the pump more than 6 times per hour. If the pump motor does not cool between starts, it will over-heat, resulting in damage to the motor windings.

**Stopping**

Follow the instructions accompanying the control box for stopping the pump.

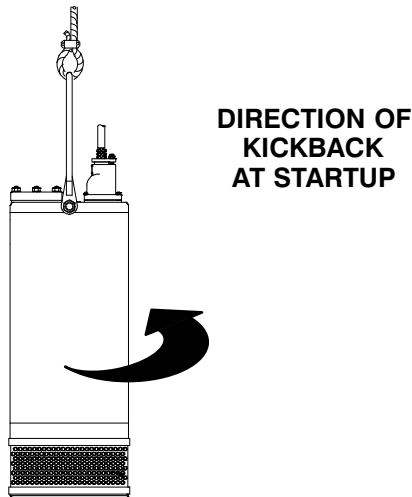

Figure C-1. Checking Pump Rotation



On pumps equipped with a motor thermal protector, the integral thermal overload device will shut off the motor if the temperature rises above design limits. When the pump cools and the temperature falls below these limits, the motor will restart automatically. To avoid the hazards of an unexpected motor start-up, do not attempt to handle or service the pump unless all power to the motor has been shut off and locked out at the control box; otherwise, serious personal injury could result.

**STARTING, STOPPING, AND OPERATIONAL CHECKS**

**Starting**

During motor shutoff by the thermal overload device, control box circuits remain live. Do not attempt to service any control box components unless incoming power has been shut off.



Do not attempt to operate the pump until impeller rotation has been checked; improper rotation will affect pump performance and may damage the pump.

To stop the pump, turn the control handle OFF, thereby opening the circuit breakers. This **does not** terminate incoming power through the field wiring connected to the control box.

After stopping the pump, be sure to perform all required maintenance and preservation procedures.

**Operational Checks**

Follow the instructions accompanying the control box, start the pump, and run any recommended checks.

To detect minor problems, check the pump for proper operation when it is first started, and at periodic intervals during operation.

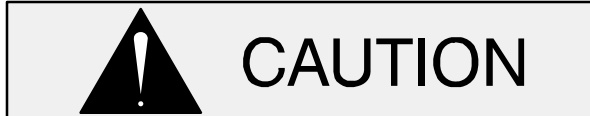

To avoid serious damage to the pump, check for unusual noises or excessive vibration while the pump is running. If noise or vibration is excessive, stop operation and refer to the troubleshooting chart in the maintenance and repair manual.

The suction inlet or impeller may become clogged with debris. In some cases, stopping the pump momentarily may backflush this blockage. If backflushing does not clear the debris, remove the pump from the sump or wet well and clear manually.



**Never introduce air or steam pressure into the pump casing to remove a blockage. This could result in personal injury or damage to the equipment. If backflushing is absolutely necessary, limit liquid pressure input to 50% of the maximum permissible operating pressure shown in the pump performance curve (refer to the accompanying Parts List Manual).**

Check the pump for overheating. Overheating can occur if the pump is misapplied, required to start repeatedly, if the control box fails to provide overload or thermal protection, or if the pump is operated against a closed discharge valve for an extended period of time.



Do not start the pump more than 6 times per hour. If the motor does not cool between starts it will overheat, resulting in damage to the motor windings.

Check the oil level(s) as indicated in the following **LUBRICATION** section.

## COLD WEATHER PRESERVATION



**Do not attempt to thaw the pump by using a torch or other source of flame. This could damage gaskets, O-rings or heat the oil in the seal housing above critical temperatures, causing the pump to rupture or explode.**

The pump will not freeze as long as the casing is submerged in liquid. If the casing is not submerged, or if the liquid begins to freeze, remove the pump from the sump or wet well and dry it thoroughly. Run the pump for two or three minutes to dry the inner walls.

If the pump does freeze while it is out of the liquid, submerge it until thawed; if the liquid is near freezing, the pump must be submerged for an extended period of time. Check thawing by starting the pump and checking that the shaft rotates freely. If the pump remains frozen, allow additional thawing time before attempting to restart.

If submerging does not thaw the pump, move it into a warm area until completely thawed.

## LUBRICATION



**Do not remove plates, covers, gauges, pipe plugs or fittings from an overheated pump. Vapor pressure within the pump can cause parts being disengaged to be ejected with great force. Allow the pump to completely cool before servicing.**

On a new pump, check the oil level in both seal and motor cavities (if oil lubricated) before initial start-up, and drain and replace the oil after the first 200 hours of operation. Following this, check the oil level in the seal cavity after the first two weeks of op-

eration, and every month thereafter. Check the motor lubrication level any time the pressure relief valve is activated, and replace the oil annually.

Before installing or removing the lubrication plug(s), always clean the area around the plug(s) to prevent contamination.

### Draining Oil

Refer to the Parts List Manual for drain plug location.

For the smaller pump, lay the pump horizontal on a flat work surface with the seal cavity drain plug facing up. Remove the drain plug slowly to release any pressure. Install a short pipe nipple in the hole. Place a clean container under the plug and roll the pump on its side to drain the seal housing.

For the larger pump, remove the drain plug slowly to release any pressure. Install a short pipe nipple in the hole. Place a clean container under the plug and using a hoist, tilt the pump at an angle of approximately 60 degrees.

If the motor is oil-cooled, repeat the procedure for the motor housing oil.

### Condition Of Oil

Check the condition of the oil drained from the pump. Clear oil indicates that the pump seal(s) are functioning properly. If the oil is milky or contains a small amount of water, it must be changed.

If the oil contains a large amount of water, it must be changed, and the seal(s) must be checked be-

fore the pump is put back in operation (refer to the Maintenance and Repair Manual).

### Adding Oil

Due to differences in pump design, the quantity of oil and manner in which oil is to be added to the seal cavity varies between pump models. Refer to Table B-2 in **INSTALLATION** for oil capacities and positions for filling the seal cavity in each pump. Motor cavities requiring lubrication should always be positioned vertically for filling.

The grade of lubricant used is critical to the operation of this pump. Use premium quality submersible pump oil as specified in the following table. Oil must be stored in a clean, tightly closed container in a reasonably dry environment.

When lubricating the seal cavity, remove the lubrication plug as indicated in **Draining Oil**, and position the pump as indicated in Table B-2. Add premium quality submersible pump oil through this plug hole. If the pump is to be positioned vertically or at an angle, fill the cavity to the bottom of the plug hole. If the pump is to be positioned horizontally, completely fill the cavity.

Install and tighten the lubrication plug.

When lubricating the motor cavity, add oil through the hole for the pressure relief valve. If the pump is equipped with a motor lubricant level plug, remove this plug and fill the cavity until oil escapes through the hole. If the pump is not equipped with a motor lubricant level plug, fill the cavity to the top of the hole.

Reinstall the pressure relief valve.

**Table C-1. Pump Oil Specifications**

Specifications:	
Type .....	Premium high viscosity index, anti-wear hydraulic oil
Viscosity @ 100°F (38°C) .....	110 to 155
Viscosity @ 210°F (99°C) .....	40 to 50
Dielectric .....	26,000 (volts-min)
Recommended supplier:	
Gulf Oil Company .....	Gulf Harmony HVI AW 26
Acceptable alternate suppliers:	
Gulf Oil Company .....	Gulf Harmony 32 AW
Texas Oil Company .....	Rando HD 32 or HD AZ 32
Sun Oil Company .....	Sunvis 816 or 916
BP (Also Boron) .....	Energol-HLP 32
Shell Oil Company .....	Tellus 32, Tellus T-23 or T32
ARCO .....	Duro 32
Exxon (Also Esso) .....	Nuto H 32
Petro-Canada .....	Harmony HVI 22

## TROUBLESHOOTING – SECTION D

Review all SAFETY information in Section A.



The following precautions should be taken before attempting to service the pump; otherwise, injury or death could result.

1. Familiarize yourself with this manual and with all other literature shipped with the pump.
2. Lock out incoming power to the pump or control box to ensure that the pump will remain inoperative.
3. Allow the pump to completely cool if overheated.
4. Check the temperature before opening any covers, plates or plugs.

5. Close the discharge valve (if used).



The electrical power used to operate this pump is high enough to cause injury or death. Obtain the services of a qualified electrician to troubleshoot, test and/or service the electrical components of this pump.

### NOTE

*Many of the probable remedies listed below require use of electrical test instruments; for specific procedures, see **ELECTRICAL TESTING** following the chart.*

**Table 1. Trouble Shooting Chart**

TROUBLE	POSSIBLE CAUSE	PROBABLE REMEDY
<b>PUMP FAILS TO START, OVERLOAD UNIT NOT TRIPPED (MANUAL MODE)</b>          <b>(AUTOMATIC MODE)</b>	Power source incompatible with control box.	Correct power source.
	No voltage at line side of circuit breaker.	Check power source for blown fuse, open overload unit, broken lead, or loose connection.
	Open circuit in motor windings or power cable.	Check continuity.
	Defective motor power cable.	Replace cable.
	Motor defective.	Check for and replace defective unit.
	Liquid level device or control circuits improperly connected to main control box.	Check wiring diagrams; correct or tighten connections.
	Level sensing device(s) improperly positioned.	Position device(s) at proper level.
	Level sensing device(s) fouled with mud or foreign material.	Clean sensing device(s).

Table 1. Trouble Shooting Chart (cont.)

TROUBLE	POSSIBLE CAUSE	PROBABLE REMEDY
<b>(AUTOMATIC MODE) (CONT'D.)</b>	Float type sensing device(s) tangled or obstructed.	Check installation for free movement of float.
	Defective liquid level sensing device(s) or control panel.	Repair or replace defective unit(s).
<b>OVERLOAD UNIT TRIPS</b>	Low or high voltage, or excessive voltage drop between pump and control box.	Measure voltage at control box. Check that wiring is correct type, size, and length. (See <b>Field Wiring Connections</b> , Section B).
	Defective insulation in motor windings or power cable; defective windings.	Check insulation resistance; check continuity.
	Impeller jammed due to debris or insufficient clearance.	Disassemble pump and check impeller.
	Bearing(s) frozen.	Disassemble pump and check bearing(s).
<b>MOTOR RUNS, BUT PUMP FAILS TO DELIVER RATED DISCHARGE</b>	Discharge head too high.	Reduce discharge head, or install staging adaptor and additional pump.
	Low or incorrect voltage.	Measure control box voltage, both when pump is running and when shut-off.
	Discharge throttling valve partially closed; check valve is installed improperly.	Open discharge valve fully; check piping installation.
	Discharge line clogged or restricted; hose kinked.	Check discharge lines; straighten hose.
	Liquid being pumped too thick.	Dilute liquid by heating if possible.
	Strainer screen or impeller clogged.	Clear clog(s). Stop pump; back flow may flush away debris.
	Insufficient liquid in sump or tank.	Stop pump until liquid level rises.
	Worn impeller vanes; excessive impeller clearance.	Check impeller and clearance. See <b>PUMP END REASSEMBLY</b> .
Pump running backwards.	Check direction of rotation and correct by interchanging any two motor leads at control box. (See <b>Pump Rotation</b> , Section C).	

**Table 1. Trouble Shooting Chart (cont.)**

<b>TROUBLE</b>	<b>POSSIBLE CAUSE</b>	<b>PROBABLE REMEDY</b>
<b>PUMP RUNS WITH EXCESSIVE NOISE OR VIBRATION</b>	Pumping entrained air.	Check liquid level in sump; check position of pump and liquid level sensing device(s).
	Damaged or unbalanced impeller.	Replace impeller.
	Discharge piping not properly supported.	Check piping installation.
	Impeller jammed or loose.	Check impeller.
	Motor shaft or bearings defective.	Disassemble pump and check motor and bearings.
	Pump cavitation.	Reduce discharge head, or restrict flow on low head applications.

**ELECTRICAL TESTING**

If you suspect that pump malfunctions are caused by defects in the motor, power cable or control box, perform the following checks to help isolate the defective part.

<b>Equipment</b>	<b>Use</b>
Ammeter	To check AC Voltage and current (amperage)
Ohmmeter	To measure resistance (ohms) to ground



**Obtain the services of a qualified electrician to troubleshoot, test and/or service the electrical components of this pump.**



Be certain to refer to the wiring diagram(s) in the Installation Section of this manual before reconnecting any electrical components which have been disconnected.

**Test Equipment**

A volt/amp/ohmmeter and megohmmeter of adequate range and quality will be required to conduct the following electrical tests. The suggested equipment indicated below is commercially available, or an equivalent substitute may be used.

**Voltage Imbalance**

Each phase of the incoming three-phase power must be balanced with the other two as accurately as a commercial voltmeter will read. If the phases are balanced, check out the motor as described below. If the phases are out of balance, contact your power company and request that they correct the condition.

- a. Use a voltmeter, amprobe, or equivalent meter to read the voltage across terminals 1 & 2, 2 & 3, and 1 & 3 in the control box. All three measured voltages must be the same, as accurately as the meter will read. If possible, measure the voltage with the pump off, with the pump running but out of the water, and with the pump running in the water at full load. All the measured voltages at each condition must be the same.
- b. Use an amprobe or equivalent meter to measure the current draw of each phase while the pump is running at full load and at no load. All three amperage readings must

be the same at each condition, as accurately as the meter will read. Nominal amperage values are listed in Table 1, but these apply only when the actual voltage at the site is the nominal voltage listed.

- c. If the voltages are balanced with the pump off, but are unbalanced when the pump is running, a thorough check of the power source, all interconnecting cables, and the pump motor is required to isolate the defect.

### Motor And Motor Power Cable Continuity

To check continuity, zero-balance the ohmmeter set at the RX1 scale, and test as follows:

- a. Disconnect the motor power cable leads from the control box and connect the test leads to any two of the three power cable leads (not to the green ground lead or yellow ground check lead). If there is a high resistance reading on the ohmmeter, there is an open or broken circuit caused by a break in the power cable or motor windings, or by a bad connection between the motor and the power cable. Switch one test lead to the third power lead, and test again.
- b. If an open or broken circuit is indicated, check the power cable for obvious damage, and replace as necessary (see **MAINTENANCE AND REPAIR**). If there is no apparent damage to the motor cable, remove the terminal housing (see **MAINTENANCE AND REPAIR**) and check the continuity of each power cable lead at the terminal posts.

#### NOTE

*When shipped from the factory, the connections between the power cable leads and the terminal posts were encapsulated in heat shrink tubing and bonded to the terminal plate to provide a water tight seal. In service, these connections may have been potted by the pump operator. Do not cut the tubing or potting away unless absolutely necessary. Check the continuity of each lead from the motor side of the terminal plate. If the continuity is good, there is no need to remove the tubing or potting material. If there is no continuity through the lead, remove the tubing or potting from only that terminal, and check for a loose connection. Be sure to re-*

*place the tubing or potting and allow adequate drying time before putting the pump back into service. (See **Power Cable Reassembly**, Section E).*

- c. If an open circuit still exists after each lead (terminal) has been tested and tightened, then the **entire** motor power cable must be replaced. Splicing or other means of repair are not recommended.
- d. If no break is found in the power cable, check the motor leads for continuity. If the test reading indicates an open or broken circuit, there is an open circuit in the motor.

#### NOTE

*It is recommended that a pump with a defective motor be returned to Gorman-Rupp, or to one of the Gorman-Rupp authorized Submersible Repair Centers.*

### Insulation Resistance

To check insulation, zero-balance the ohmmeter set at the RX100K scale, and test as follows:

- a. Disconnect the motor power cable leads from the control box. Connect one test lead to the power cable green ground lead, and touch the other test lead to each of the three power leads in turn.
- b. The reading obtained will indicate resistance values in both the power cable and the motor windings. If the resistance reading is infinity ( $\infty$ ), the insulation is in good condition. If the reading is between infinity ( $\infty$ ) and 1 megohm, the insulation is acceptable but should be rechecked periodically. If the reading is less than 1 megohm, the insulation should be checked more closely; a reading of zero indicates that the power cable or the motor is grounded.
- c. To determine whether the power cable or the motor is grounded, remove the terminal housing (see **MAINTENANCE AND REPAIR**), disconnect the motor leads from the motor terminals, and test the power cable leads and motor leads separately.

## PUMP MAINTENANCE AND REPAIR - SECTION E

**MAINTENANCE AND REPAIR OF THE WEARING PARTS OF THE PUMP WILL MAINTAIN PEAK OPERATING PERFORMANCE.**

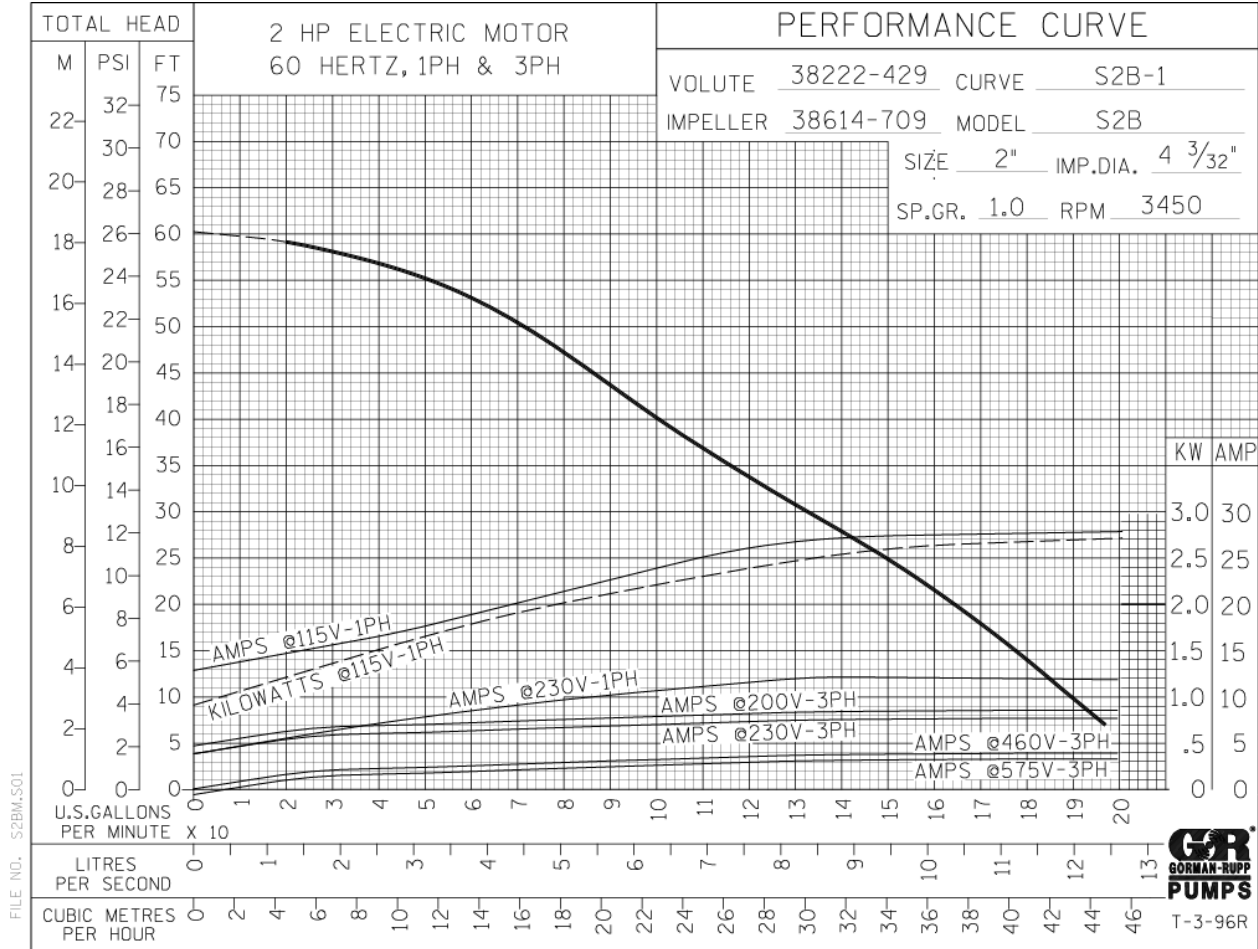

**\* STANDARD PERFORMANCES FOR PUMP MODEL S2B65-E2 230/1**

\* Based on 70°F (21°C) clear water at sea level with minimum suction lift. Since pump installations are seldom identical, your performance may be difference due to such factors as viscosity, specific gravity, elevation, temperature, and impeller trim.

Contact the Gorman-Rupp Company to verify performance or part numbers.



Pump speed and operating condition points must be within the continuous performance range shown on the curve.

If your pump serial number is followed by an "N", your pump is **NOT** a standard production model.

ILLUSTRATION

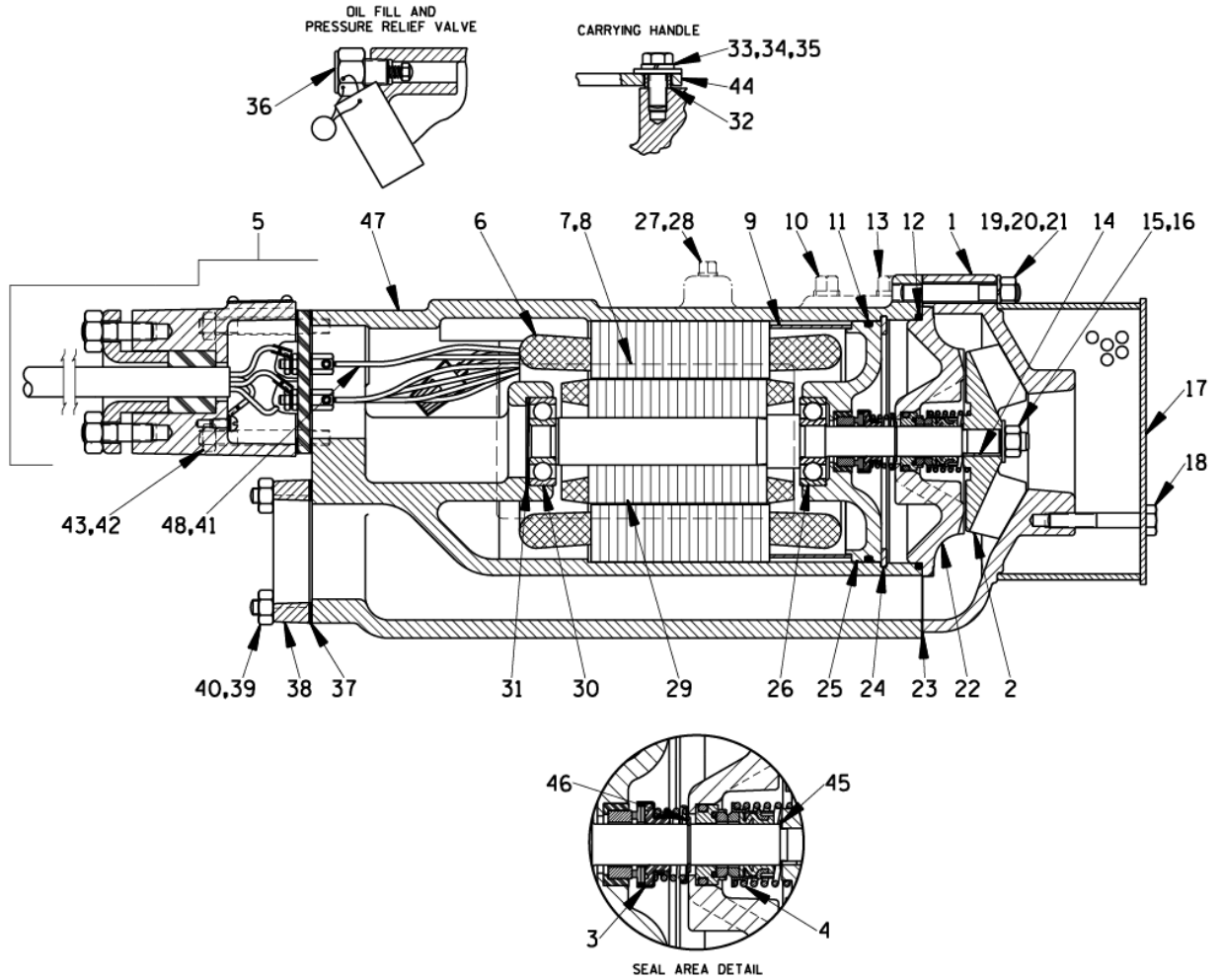

Figure 2. Pump Model S2B65-E2 230/1

**PARTS LIST**  
**Pump Model S2B65-E2 230/1**  
 (From S/N 1866560 Up)

If your pump serial number is followed by an "N", your pump is **NOT** a standard production model. Contact the Gorman-Rupp Company to verify part numbers.

ITEM NO.	PART NAME	PART NUMBER	QTY	ITEM NO.	PART NAME	PART NUMBER	QTY
1	SUCTION CASING	38222-429	17180 1	32	BUSHING	10194 17090	2
2	IMPELLER	38614-709	1718H 1	33	HEX HD CAP SCREW	B0604 17090	2
3 *	MECH SEAL	25271-824	1	34	FLAT WASHER	KB06 17090	2
4 *	SEAL ASSEMBLY	46512-069	1	35	LOCK WASHER	J06 17090	2
5	TERM HSG & CABLE ASSY	47367-050	1	36 *	RELIEF VALVE ASSY	46431-646	1
6	STATOR	47113-854	1	37 *	FLANGE GASKET	10195G 19370	1
7	NAME PLATE	38818-039	17090 1	38	DISCHARGE FLANGE	10195 17070	1
8	DRIVE SCREW	BM#04-03	17090 6	39	STUD	C0506 17090	4
9	MOTOR BUSHING	31173-018	23010 1	40	HEX NUT	D05 17090	4
10	PIPE PLUG	P04 17090	1	41	CONNECTOR	S1718	1
11 *	O-RING	25152-248	1	42	STUD	C0511 17090	4
12 *	O-RING	25154-250	1	43	HEX NUT	D05 17090	4
13	PIPE PLUG	P04 17090	1	44	HANDLE	10185A 17050	1
14	KEY	N0202-1/2	17090 1	45 *	ADJ SHIM SET	669 17090	1
15	FLAT WASHER	21161-828	1	46	SNAP RING	24124-322	1
16	HEX NUT	D06 17090	1	47	MOTOR HOUSING	38311-029	17070 1
17	STRAINER ASSY	46611-009	24170 1	48	HEAT-SHRINK TUBE	31411-235	19450 1
18	NYLOCK CAP SCREW	BT0508	17090 4	NOT SHOWN:			
19	STUD	C0610	17090 4		CONTROL BOX ASSY	48319-105	1
20	LOCK WASHER	J06 17090	4		CABLE TIE	27111-211	1
21	HEX NUT	D06 17090	4		SUB PUMP OIL	9568	1
22	SEAL PLATE	38272-830	1718H 1		MOTOR VOLTAGE TAG	38816-098	1
23 *	CASING GASKET	38674-807	19370 1		INSTRUCTION TAG	6588AC	1
24	RETAINING RING	24121-077	1		G-R DECAL 3"	GR-03	1
25	INTERMEDIATE BRKT	38261-015	13040 1	OPTIONAL:			
26 *	BALL BEARING	S1512	1		REPAIR GASKT KIT	11000T	1
27	A HD SET SCREW	GA0501-1/4	15990 1		STAGING ADAPTOR KIT	48272-002	1
28	PIPE PLUG	P02 17090	1	LIQUID LEVEL DEVICES:			
29 *	ROTOR & SHAFT ASSY	47112-802	1		FLOAT TYPE	27471-180	1
30 *	BALL BEARING	S1512	1		120V LIQUID LVL CNTL	27521-322	1
31	SPRING WASHER	S1554	1				

\* INDICATES PARTS RECOMMENDED FOR STOCK

ILLUSTRATION

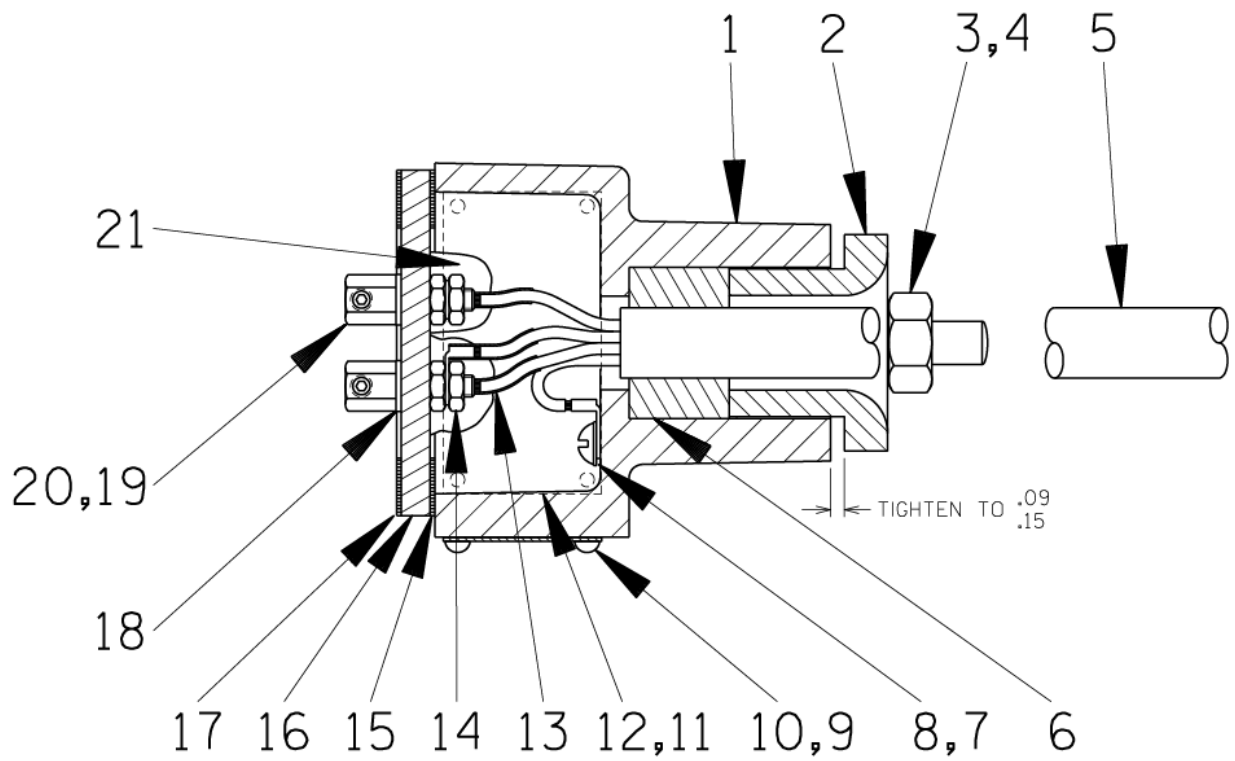

Figure 3. Terminal Housing & Cable Assembly

## PARTS LIST

## Terminal Housing &amp; Cable Assembly

ITEM NO.	PART NAME	PART NUMBER	QTY
1	TERMINAL HOUSING	38381-229 17070	1
2	TERMINAL CAP	38381-624 17070	1
3	STUD	C0606 17090	2
4	HEX NUT	D06 17090	2
5	* CABLE ASSEMBLY	47351-052	1
6	BUSHING	10758H 19540	1
7	RD HD MACH SCREW	X#10-01 1/2 14990	1
8	T TYPE LK WASHER	AK#10 15991	1
9	INFO PLATE	38816-047 17050	1
10	DRIVE SCREW	BM#04-03 17090	4
11	MOTOR PLATE	10436 17050	1
12	DRIVE SCREW	BM#04-03 17090	4
13	HEAT-SHRINK TUBE	31411-203 19530	3
14	HEX NUT	D#10 14990	6
15	* FLANGE GASKET	10195G 19370	1
16	TERMINAL PLATE	38713-007 23010	1
17	* FLANGE GASKET	10195G 19370	1
18	DYNA-SEAL WASHER	S1590	3
19	TERMINAL	11181 14100	3
20	A HD SETSCREW	GA#10-01S 15991	3
21	RTV SEALANT	18771-106	1

\* INDICATES PARTS RECOMMENDED FOR STOCK

## PUMP END DISASSEMBLY

Review all SAFETY information in Section A.

Follow the instructions on all tags, label and decals attached to the pump.

The following maintenance and repair instructions are keyed to the illustrations (Figure 1 and 2) and the accompanying parts lists. Refer to the Parts List manual for the part number and quantity required.

Before attempting to service the pump or control, terminate the power supply to the control box. Close the discharge throttling valve, if so equipped.



**The electrical power used to operate this pump is high enough to cause injury or death. Make certain that the control handle on the control box is in the off position and locked out, or that the power supply to the control box has been otherwise cut off and locked out, before attempting to open or service the pump assembly. Tag electrical circuits to prevent accidental start-up.**

Use the hoisting bail to remove the pump from the wet well or sump, and move it to a location where the discharge line can be removed. It is not necessary to disconnect a flexible discharge hose before removing the pump. If rigid discharge piping is used, disconnect the piping before attempting to move the pump.



**Do not attempt to lift the pump by the motor power cable or the piping. Attach proper lifting equipment to the lifting device fitted to the pump. If chains or**

**cable are wrapped around the pump to lift it, make certain that they are positioned so as not to damage the pump, and so that the load will be balanced.**

Select a suitable location, preferably indoors, to perform the degree of maintenance required. If the motor housing is to be opened, the work must be done in a clean, well-equipped shop. All maintenance functions must be done by qualified personnel.

Check the chart in **TROUBLESHOOTING**, Section B of this manual, to determine the nature of the pump problem. If the problem is mechanical in nature, such as worn pump parts, seal replacement, lubrication, etc., refer to **PUMP END DISASSEMBLY** for instructions.

If the problem is electrical, complete disassembly may not be required. Refer to **Electrical Testing** in **TROUBLESHOOTING**, Section B, and have a qualified electrician check the control box, cable and terminal housing. If the problem is determined to be in the motor, proceed with **PUMP END DISASSEMBLY**, followed by **MOTOR DISASSEMBLY**. Otherwise, see **Terminal Housing And Power Cable Disassembly**.

Carefully inspect any O-rings or gaskets before removal and cleaning to determine if a proper seal and compression existed prior to disassembly. If sealing was faulty or questionable, the cause must be determined and corrected before reassembly. All gaskets and most O-rings **must** be replaced if disturbed. Repair gaskets and O-rings are listed in the Parts List manual.

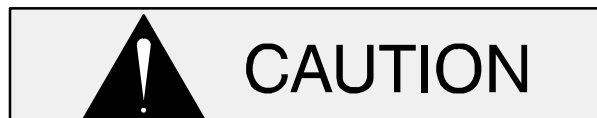

Use **Only Genuine Gorman-Rupp** replacement parts. Failure to do so may create a hazard and damage the pump or diminish optimal pump performance. Any such hazard, damage or diminished performance is not covered by the warranty.

**NOTE**

*When appropriate recycling facilities are available, the user should recycle components and fluids when doing any routine maintenance / repairs and also at the end of the pump's useful life. All other components and fluids shall be disposed of according to all applicable codes and regulations.*

**Strainer Removal****(Figure 1)**

To remove the strainer assembly (17), raise the pump slightly, or lay it on its side and disengage the hardware (18) securing the strainer to the suction casing (1). If the impeller (2) is clogged, the debris can usually be removed without further disassembly.

**Draining Oil From Seal Cavity****(Figure 1)**

If any further disassembly is to be performed on the pump, the seal oil cavity must be drained.



Let the pump cool before removing the seal cavity drain plug. Pressure built up within a hot pump could cause the oil to spray out when the plug is removed. Remove the plug slowly and permit pressure to vent to atmosphere.

Lay the pump on its side with the pipe plugs (10 and 13) facing up. Clean any dirt from around the plugs. Remove the seal cavity drain plug (13), and install a short 1/4-inch NPT nipple in the hole. Tip the pump and drain the seal oil into a **clean** container. Inspect the oil for water, dirt, or cloudy condition which could indicate lower seal failure or poor gasket seal.

**Draining Oil From Motor Cavity****(Figure 1)**

If motor problems are suspected, remove the motor cavity drain plug (10), and install a short nipple in the hole. Tip the pump and drain the motor oil into a **clean** container. Inspect the oil for dark color which could indicate motor overheating, water or dirt contamination. The presence of dirt or water could indicate a breakdown in the waterproof integrity of the motor cavity, probably due to poor gaskets or seals.

**Positioning Pump For Disassembly****(Figure 1)**

It is recommended that the pump be positioned upside-down during disassembly. To hold the pump in the inverted position, rest the pump securely on blocks or screw a pipe in the discharge flange (38) and clamp it in a large vise. Be careful not to damage the terminal housing and cable assembly (5) while in this position. Use adequate equipment and personnel to safely handle the pump until it is secured. If inverting the pump is not practical, lay the pump on its side and secure it to prevent rolling.

**Suction Casing Removal****(Figure 1)**

To remove the suction casing (1), disengage the hardware (20 and 21) securing the suction casing and seal plate (22) to the motor housing (47). Remove the suction casing. Remove and discard the casing gasket (23).

**Impeller Removal****(Figure 1)**

Wedge a piece of wood between the vanes of the impeller (2) and the motor housing studs (19). Remove the impeller nut (16) and washer (15).

Remove the wood and pry the impeller off the shaft using two pry bars. Use caution when removing the impeller; tension on the seal spring will be released. Retain the impeller key (14). The seal plate will become a free part.

Remove the impeller adjusting shim set (45). For ease of reassembly, tie and tag the shims or measure and record their thickness.

### Lower Seal Removal

(Figures 1 and 3)

Carefully remove the seal spring. Lubricate the rotor shaft (29) and work oil under the bellows assembly. Use a pair of screwdrivers or the hooked ends of two stiff wires to pull the rotating portion of the seal off the shaft.

To remove the stationary portion of the seal, pry the seal plate (22) from the motor housing (47). Remove and discard the seal plate O-ring (12). Place the seal plate on a clean cloth with the impeller side down. Use a drift pin or screwdriver to press on alternate sides of the stationary seat until the stationary element and seat are removed.

If no further disassembly is required, proceed to the appropriate areas in **PUMP END REASSEMBLY**.

### Upper Seal Removal

(Figures 1 and 3)

Unless cracked or otherwise worn, it is not necessary to remove the intermediate (25) for access to the upper seal assembly (3).

Remove the seal retaining ring (24) using snap ring pliers. Use caution when removing the retaining ring; tension on the seal spring will be released. Remove the spring retainer and seal spring.

Lubricate the rotor shaft (29) and work oil under the bellows. Use a pair of screwdrivers or the hooked ends of two stiff wires to pull the rotating portion of the seal off the shaft.

Slide the hooked ends of the two wires along the shaft and under the stationary seal seat. Hook the back side of the seat and pull it from the intermediate bore.

If no further disassembly is required, proceed to the appropriate areas in **PUMP END REASSEMBLY**.

### NOTE

*Do not disassemble the motor unless it is necessary and a clean, well-equipped shop is available. If the motor housing components are to be serviced, see **MOTOR DISASSEMBLY** in this section. Do not reassemble the pump end components at this time.*

## PUMP END REASSEMBLY

### NOTE

*Reuse of old O-rings, gaskets, or shaft seal parts will result in premature leakage or reduced pump performance. It is strongly recommended that new gaskets and shaft seal assemblies be used during reassembly (see the parts lists for numbers).*

### Cleaning And Inspection Of Pump Parts

(Figure 1)

With the pump inverted, stuff a clean tissue into the stationary seal seat bore of the intermediate (8) or wrap a small rag around the shaft to prevent foreign material from entering the motor cavity.

Carefully inspect any O-rings or gaskets before removal and cleaning to determine if a proper seal and compression existed prior to disassembly. If sealing was faulty or questionable, the cause must be determined and corrected before reassembly. Replace any parts as required.

Thoroughly clean all reuseable parts with a soft cloth soaked in cleaning solvent. Remove all O-rings and gaskets, and clean the sealing surfaces of dirt or gasket material. Be careful not to scratch gasket surfaces.



**Most cleaning solvents are toxic and flammable. Use them only in a well ventilated area free from excessive heat, sparks, and flame. Read and follow all precautions printed on solvent containers.**

Inspect the rotor shaft (29) for damaged threads, scoring, or nicks. Remove nicks and burrs with a

fine file or emery cloth to restore original contours. If the shaft is bent or severely damaged, the rotor and shaft must be replaced as an assembly (see **MOTOR DISASSEMBLY**).

Neither of the shaft seal assemblies (3 or 4) should be reused because wear patterns on the finished faces cannot be realigned during reassembly. This could result in premature failure. If necessary to reuse an old seal in an **emergency**, **carefully** wash all metallic parts in fresh cleaning solvent and allow to dry thoroughly.

Handle the seal parts with extreme care to prevent damage. Be careful not to contaminate the precision finished faces; even fingerprints on the faces can shorten seal life. If necessary, clean the faces with a non-oil based solvent and a clean, lint-free tissue. Wipe **lightly** in a circular pattern to avoid scratching the faces.

Inspect the seal components for wear, scoring, grooves, and other damage that might cause leakage. If any components are worn, replace the complete seal; **never mix old and new seal parts**.

Install the shaft seals as illustrated in Figure 3.

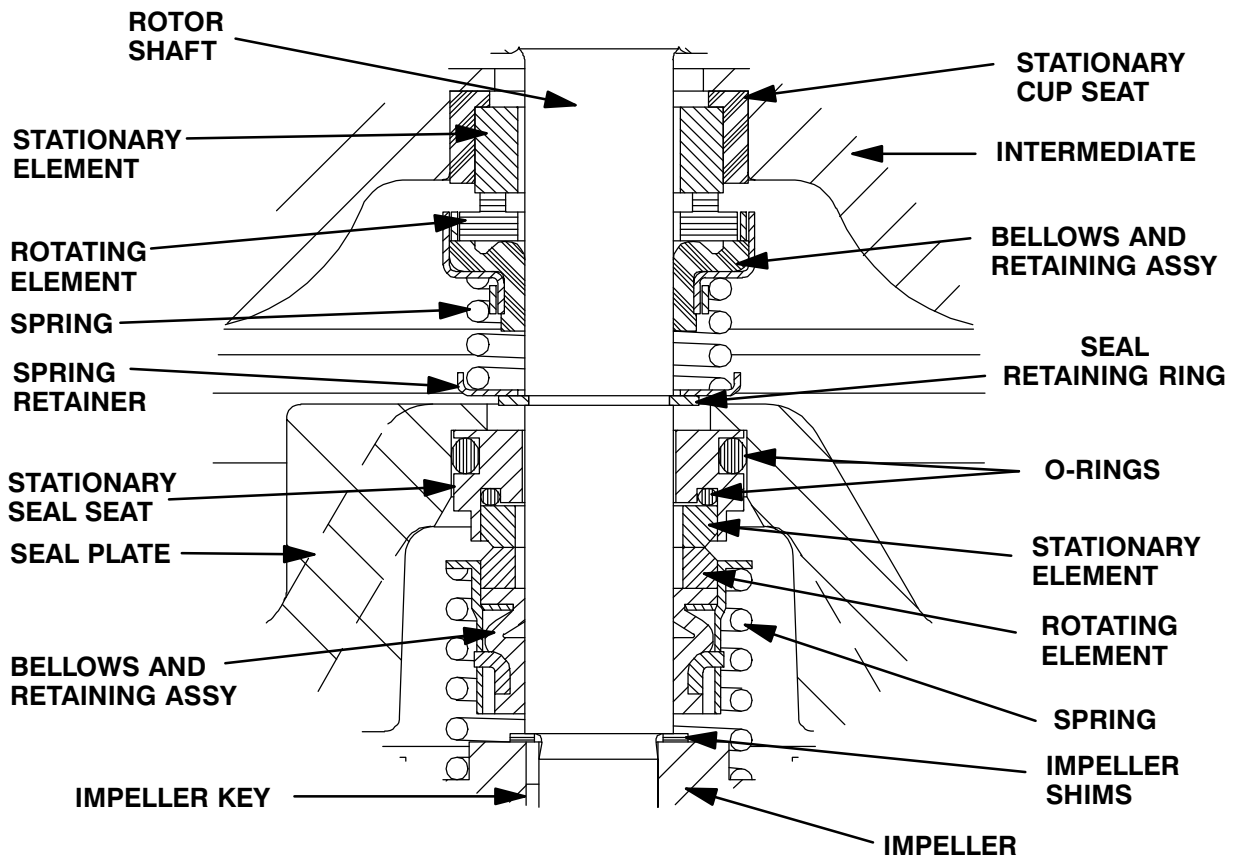

Figure 3. Upper And Lower Seal Assemblies



This seal is not designed for operation at temperatures above 122° F (50° C). Do not use at higher operating temperatures.

Upper Seal Installation

(Figures 1 and 3)

**Do not** unwrap a new seal assembly until time of installation. Cleanliness of seal components is critical, especially the seal faces.

Clean the rotor shaft (29) and seal cavity area of the intermediate (25). Be sure the area is dry and free of lint and dirt. Check the seal bore for burrs or nicks that might prevent a good seal. Apply a **light** coating of oil to the bore.

Carefully remove the material stuffed into the seat bore (or unwrap the shaft). **Be sure** no debris stopped by the material falls into the motor cavity.

### NOTE

*When pressing seal components onto the shaft, use hand pressure only. A push tube cut from a length of plastic pipe will aid in installing seal components. The I.D. of the push tube should be approximately the same as the I.D. of the seal spring.*

---

Subassemble the stationary element in the stationary seat. Position this subassembly in the intermediate bore with the sealing face up and cover the seal face with a clean tissue. Use your thumbs to press the assembly into the bore. Apply equal pressure on opposite sides until the seat contacts the bore shoulder. Remove the tissue and inspect the seal face to ensure that it is clean and dry. If cleaning is necessary, use clean tissue to wipe **lightly** in a concentric pattern.

Unpack the rotating portion of the seal. Be certain the seal face of the rotating element is free of grit or surface damage. Because the rotating element may not stay in the bellows retainer when turned upside down, place a **small** amount of grease at equal spaces on the back of the element and position it in the bellows retainer. The grease should hold the element in position until the seal is installed. Assemble the drive grooves of the rotating element into the drive lugs of the bellows retainer.

Apply a **light** coating of oil to the seal seating surface on the shaft, the groove for the retaining ring (24), and I.D. of the bellows. Inspect the seal face to ensure that it is clean and dry. If cleaning is necessary, use a clean tissue to wipe in a circular pattern. Slide the seal rotating portion onto the lubricated shaft as shown in Figure 3. Apply firm, steady pressure on the seal retainer until it slides down the shaft and the seal faces contact.

Slide the seal spring over the shaft and bellows retainer, and install the spring retainer. Carefully compress the seal spring and install the seal retain-

ing ring (24). See Figure 3 for the proper order of seal assembly.

### Lower Seal Installation

(Figures 1 and 3)

Thoroughly clean the gasket surfaces and seal bore of the seal plate (22). The seal bore must be free of burrs and nicks which could damage the seal. Inspect the seal plate for cracks, distortion, or erosion and replace it if defective.

Lightly oil the seal plate O-ring (12) and install it on the seal plate. Position the seal plate on a clean flat surface with the impeller side up.

Unpack the stationary seat and element, and check that the O-rings are properly installed (see Figure 3). Subassemble the stationary element in the stationary seat. Apply a **light** coating of oil to the seal plate bore and the O.D. of the of the seal seat. Keep the sealing face dry.

Position the subassembly in the seal plate bore, and cover it with a clean tissue. Use your thumbs to press the seat into the bore. Apply equal pressure on opposite sides of the seat until it is fully seated in the bore. Remove the tissue and inspect the seal face to ensure that it is clean and dry. If cleaning is necessary, use clean tissue to wipe **lightly** in a circular pattern.

### NOTE

*When pressing seal components onto the rotor shaft, use hand pressure only. A push tube cut from a length of plastic pipe will aid in installing seal components. The I.D. of the push tube should be approximately the same as the I.D. of the seal spring.*

---

Carefully position the seal plate and stationary seal components over the rotor shaft and against the intermediate. **Be careful** not to damage the stationary element or seal plate O-ring (12) already installed.

Unpack the rotating portion of the seal. Be certain the seal face of the rotating element is free of grit or surface damage. Because the rotating element may not stay in the bellows retainer when turned upside down, place a **small** amount of grease at equal spaces on the back of the element and posi-

tion it in the bellows retainer. The grease should hold the element in position until the seal is installed. Assemble the drive grooves of the rotating element into the drive lugs of the bellows retainer. Apply a **light** coating of oil on the shaft and the I.D. of the bellows.

Slide the rotating subassembly onto the lubricated shaft with the seal face down. Apply firm, steady pressure on the bellows retainer until it slides down the shaft and the seal faces contact.

Slide the seal spring over the shaft and bellows retainer. See Figure 3 for proper order of seal assembly.

### Impeller Installation

#### (Figure 1)

Inspect the impeller (2) for cracks, broken vanes, or wear from erosion, and replace it if damaged. Clean the threads on the rotor shaft to remove any old thread locking material.

Install the same thickness of impeller adjusting shims (45) as previously removed on the rotor shaft. Install the impeller key (14) in the shaft keyway, align the impeller keyway, and press the impeller onto the shaft until it seats firmly against the adjusting shims.

### NOTE

*The clearance between the face of the impeller and the suction casing can only be measured after the impeller and suction casing are fully installed.*

**After** the impeller is installed, coat the threads of the rotor shaft with 'Loctite Threadlocker No. 242' or equivalent compound. Install the impeller washer (15) and nut (16). Place a block of wood between the vanes of the impeller and housing studs (19) to prevent shaft rotation, and torque the impeller nut to 20 ft. lbs. (240 in. lbs. or 8 m. kg.).

Remove the block of wood and turn the impeller to check for free rotation. Check the front clearance after installing the suction casing (1).

### NOTE

*After the impeller has been properly positioned, check for free rotation. Correct any scraping or binding before further reassembly.*

### Suction Casing Reassembly

#### (Figure 1)

Inspect and thoroughly clean the suction casing (1) and its gasket surface.

Install the gasket (23) over the motor housing studs (19).

Install the suction casing over the motor housing studs. Apply 'Loctite Threadlocker No. 242' or equivalent compound to the threads of the studs. Install the hardware (20 and 21) and torque the nuts (21) to 20 ft. lbs. (240 in. lbs. or 8 m. kg.).

### Impeller Clearance

#### (Figure 1)

There should be a clearance of .003 to .010 inch (0,07 and 0,25 mm) between the suction casing (1) and the face of the impeller. Reach into the suction casing with a feeler gauge to measure this clearance.

If the impeller clearance is not within specified limits, remove the suction casing and the impeller, then add or remove impeller adjusting shims (45) as required. Reinstall the impeller and suction casing, and recheck clearance.

### Strainer Installation

#### (Figure 1)

Inspect the strainer assembly (17) for cracks, distortion or erosion, and replace it if defective.

Position the strainer squarely on the shoulder of the suction casing (1) and secure with the nylock capscrews (18). Make certain that the strainer seats properly against the shoulder of the suction casing.

See **LUBRICATION** and **FINAL ASSEMBLY** before putting the pump back into service.

## MOTOR DISASSEMBLY

Disassembly of the motor is rarely required except to replace the motor rotor, stator or bearings. Do not disassemble the motor unless it is necessary and a clean, well-equipped shop is available.

### NOTE

*It is recommended that a pump with a defective motor be returned to Gorman-Rupp, or to one of the Gorman-Rupp authorized Submersible Repair Centers.*



**The electrical power used to operate this pump is high enough to cause injury or death. Make certain that the control handle on the control box is in the OFF position and locked out, or that the power supply to the control box has been otherwise cut off and locked out, before attempting to open or service the pump assembly. Tag electrical circuits to prevent accidental start-up.**

Carefully inspect any O-rings or gaskets before removal and cleaning to determine if a proper seal and compression existed prior to disassembly. If sealing was faulty or questionable, the cause must be determined and corrected before reassembly. Replace any parts as required.

### Terminal Housing And Power Cable Removal And Disassembly

#### (Figure 1)

Total disassembly of the terminal housing and power cable assembly (5) is not always required. Disassemble and replace **only** the parts proven defective by inspection or testing. See **Electrical Testing** in **TROUBLESHOOTING**.

The terminal housing and power cable assembly may be serviced without disassembling the motor housing or pump end or without draining the oil from the motor cavity. However, the oil **must** be

drained before attempting to disassemble the motor housing and components.

Secure the pump in an upright position. Remove the nuts (43) securing the terminal housing assembly to the motor housing (47).

#### (Figure 2)

Carefully raise the terminal housing (1) from the motor housing until the terminals (19) are accessible. Loosen the allen head setscrews (20), and disconnect the motor leads from the terminal posts. Separate the terminal housing and power cable (5) from the motor housing. Remove the lower terminal plate gasket (17).

To disconnect the power cable (5), remove the nuts (4) securing the terminal cap (2) to the terminal housing (1). Slide the cap back along the power cable. Oil the bushing (6) and terminal housing bore and pull firmly on the cable. (Allow the oil to leak in around the bushing by agitating the cable in the bore.) After the bushing has been loosened, the cable should pull out far enough to expose the bushing. Apply oil on the cable jacket and slide the bushing back along the cable. Quite often, pressure exerted on the bushing will deform the cable jacket. If this happens, additional oil and effort will be required to remove the bushing.

### NOTE

*If the rubber bushing cannot be removed from the terminal housing as indicated, it may be necessary to cut the bushing or cut the cable.*

Push approximately 6 inches (152 mm) of the power cable into the terminal housing so that the terminal plate comes free of the terminal housing. This should permit access to the power cable connections in the terminal plate.

When shipped from the factory, the connections between the power cable leads and the terminal posts (19) were encapsulated in heat-shrink tubing (13) and bonded to the terminal plate with silicone adhesive (21). (In service, the adhesive may have been replaced by potting compound

during previous repair.) If damage is extensive and the terminal plate and terminals are to be replaced, simply cut the power cable leads above the terminal collars and heat-shrink tubing, and discard the terminal plate and terminals.

If damage is not extensive and it is necessary to replace the terminal plate (16) or terminal components, carefully cut away the tubing and adhesive. Remove the nuts (14), disconnect the power cable leads from the terminal posts, and separate the terminal plate from the terminal housing. Unscrew the nuts (14), and remove the terminal posts (1) and dyna seal washers (18) from the terminal plate.

Remove the hardware (7 and 8) securing the green and yellow ground leads to the terminal housing. Reinstall the hardware.

See **Terminal Housing/Power Cable Reassembly** if no further disassembly is required.

### Pump Casing And Motor Housing Disassembly

(Figure 1)

See **PUMP END DISASSEMBLY**, and remove all pump end and seal components.

With the pump end disassembled and the motor cavity drained, secure the pump in an inverted position. Using snap-ring pliers, remove the retaining ring (24) securing the intermediate (25) in the motor housing.

### Rotor Removal

(Figure 1)

Carefully pull the rotor (29), intermediate (15), and assembled bearings (26 and 30) from the stator. Use caution to prevent the rotor from falling on the stator windings. If necessary, tap the impeller end of the rotor shaft with a block of wood or soft-faced mallet to loosen the seal between the upper ball bearing (30) and the motor housing bore.

Slide the intermediate off the shaft. Remove and discard the intermediate O-ring (12).

Remove the motor bushing (29). Tip the pump to remove the spring washer (13) from the upper bearing bore.

### Bearing Removal

(Figure 1)

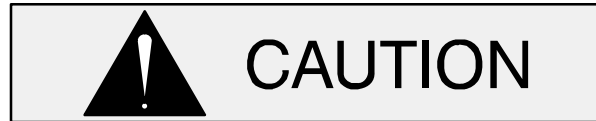

To prevent damage during removal from the shaft, it is recommended that bearings be cleaned and inspected **in place**. It is **strongly** recommended that the bearings be replaced **any** time the shaft and rotor assembly is removed.

Before removing the bearings from the rotor shaft, clean and inspect the bearings **in place** as follows.

Clean the bearings thoroughly in **fresh** cleaning solvent. Dry the bearings with filtered compressed air and coat with light oil.



**Most cleaning solvents are toxic and flammable. Use them only in a well ventilated area; free from excessive heat, sparks, and flame. Read and follow all precautions printed on solvent containers.**

Rotate the bearings by hand to check for roughness or binding and inspect the bearing balls. If rotation is rough or the bearing balls discolored, replace the bearings.

The bearing tolerances provide a tight press fit onto the shaft and a snug slip fit into the motor housing and bearing bore. Replace the shaft and rotor (as an assembly), the intermediate or the motor housing if the proper bearing fit is not achieved.

If replacement is required, use a bearing puller to remove the ball bearings from the rotor shaft.

### Stator Removal

(Figure 1)

Do not remove the stator (6) unless it is defective (open windings, insulation resistance low, or stator core damaged). If the stator must be removed, remove the terminal housing as indicated in **Terminal Housing And Power Cable Disassembly**.

Remove the pipe plug (28) located in the motor housing, and loosen the allen head setscrews (27) located underneath the pipe plug.

Position an expandable tool, such as a split disc, approximately 2 inches (51 mm) inside the stator, and expand it tightly and squarely on the I.D. Attach a lifting device to the lifting eye of the tool, and raise the assembly approximately 1 inch (25 mm) off the work surface. Take care not to damage the stator end turns.

The motor housing (47) must be heated with a torch to expand it enough for the stator to be removed. Apply heat evenly to the outside of the motor housing; excessive heat is not required. When the motor housing is sufficiently heated, use a soft-faced mallet to rap alternate edges of the motor housing, and “walk” the stator out. Continue this process until the stator clears the motor housing.



Take care not to damage the stator end turns during removal from the motor housing.

After the stator has been removed, wrap it in clean, dry rags or other suitable material until reassembly. The stator **must** be kept clean and dry. When handling the stator, **do not** set it on the end windings; lay it on its side.



Do not attempt to rewind the stator. Winding tolerances and materials are closely controlled by the manufacturer, and any deviation can cause damage or operating problems. Replace the stator, or return it to one of The Gorman-Rupp Authorized Submersible Repair Centers or The Gorman-Rupp factory, if defective.

### Relief Valve

#### (Figure 1)

It is recommended that the relief valve assembly (36) be replaced at each overhaul, or at any time the pump motor overheats and activates the valve. Never replace this valve with a substitute which has not been specified or provided by the Gorman-Rupp Company.

When installing the relief valve, use ‘Loctite Pipe Sealant With Teflon No. 592’ or equivalent compound on the threads.

### Hoisting Bail

#### (Figure 1)

If the hoisting bail (44) requires replacement, remove the hardware (33, 34 and 35) securing the bail to the motor housing. Make sure the bushings (32) are in place when installing the hoisting bail.

## MOTOR REASSEMBLY



Do not attempt to rewind the stator. Winding tolerances and materials are closely controlled by the manufacturer, and any deviation can cause damage or operating problems. Replace the stator, or return it to one of The Gorman-Rupp Authorized Submersible Repair Centers or The Gorman-Rupp factory, if defective.

### NOTE

*Reuse of old O-rings, gaskets, shaft seal parts will result in premature leakage or reduce pump performance. It is strongly recommended that new gaskets and shaft seal assemblies be used during reassembly (see the parts lists for numbers).*

### Stator Installation

#### (Figure 1)

### NOTE

*Stator installation involves heating the motor hous-*

ing. This process must be done quickly. Therefore it is recommended that these steps be performed by two people to promote efficient installation of the stator.

Clean all gasket and O-ring surfaces, completely removing any old gasket and cement material. Inspect the sealing surfaces for burrs, nicks and pits which could cause a poor seal, and replace defective parts as required.

Thoroughly clean the inside of the motor housing (47) and the groove for the retaining ring (24) with fresh solvent. The interior **must** be dry and free of dirt or lint.



**Most cleaning solvents are toxic and flammable. Use them only in a well ventilated area; free from excessive heat, sparks, and flame. Read and follow all precautions printed on solvent containers.**

After the motor housing is thoroughly cleaned, position it on a flat surface with the discharge end down. Do not unwrap the stator (6) until the motor housing has been prepared for stator installation. The stator **must** be kept clean and dry. When handling the stator, do not set it on the end windings; lay it on its side and block it from rolling.

Test the new stator as indicated in **Electrical Testing** in **TROUBLESHOOTING**, Section D, to ensure that no damage has occurred during transit or handling.

#### NOTE

*Remove any drops of varnish from the ends of the stator before installation to ensure proper stack-up height when assembled.*

Position an expandable tool, such as a split disc, approximately 2 inches (51 mm) down inside the stator (opposite the lead wire end), and expand it tightly and squarely on the I.D. Attach a lifting device to the lifting eye of the tool, and carefully lift the assembly. Take care not to damage the stator end

turns. Slip a sleeve over the stator leads, or tape them together to protect them during installation.

#### NOTE

*Stator installation involves heating the motor housing. This process must be done quickly to allow the stator to slide into the motor housing before the housing cools.*

Heat the motor housing (47) with a torch to expand it enough for the stator (6) to be installed; when heating the motor housing, **make sure** that the stator is clear to avoid a fire hazard, or damage to the windings. Apply heat evenly to the outside of the housing; excessive heat is not required.

When the motor housing is sufficiently heated, position the stator so that the leads are in line with the terminal opening. Carefully lower the stator into the motor housing until fully seated against the housing shoulder. Be careful not to damage the stator lead insulation during reassembly. If the stator “cocks” in the motor housing, remove it and try again.

After the stator is fully and squarely seated on the motor housing shoulder, remove the expandable disc tool. Install the allen head setscrews (27) securing the stator in place; torque the setscrews to 7.5 ft. lbs. ( 90 in. lbs. or 1,04 m. kg.). Coat the threads of the pipe plugs (28) with ‘Loctite Pipe Sealant with Teflon No. 592’ or equivalent compound, and install the plug over the allen head setscrew. Untape or remove the protective sleeve from the stator leads.

Cover the motor housing with a clean, lint-free cloth while the rotor is being assembled.

#### Bearing Installation

##### (Figure 1)

Inspect the rotor shaft (29) for damaged threads, scoring in the seal area, and a nicked or damaged keyway. If the bearings were removed, inspect the bearing areas for scoring or galling. Remove nicks and burrs with a fine file or emery cloth. Inspect the rotor area for separated laminations. If the shaft is bent or damaged, or if the laminations are separated, replace the shaft and rotor (a single assembly).

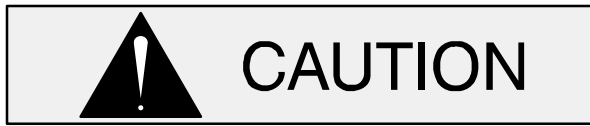

To prevent damage during removal from the shaft, it is recommended that bearings be cleaned and inspected **in place**. It is **strongly** recommended that the bearings be replaced **any** time the shaft and rotor assembly is removed.

The bearings may be heated to ease installation. An induction heater, hot oil bath, electric oven, or hot plate may be used to heat the bearings. Bearings should **never** be heated with a direct flame or directly on a hot plate.

#### NOTE

*If a hot oil bath is used to heat the bearings, both the oil and the container must be **absolutely** clean. If the oil has been previously used, it must be **thoroughly** filtered.*

Heat the bearings (26 and 30) to a uniform temperature **no higher than 250°F (120°C)**. Slide the bearings onto the shaft one at a time until they are fully seated against the shaft shoulder. This should be done quickly, in one continuous motion, to prevent the bearings from cooling and sticking on the shaft.



Use caution when handling hot bearings to prevent burns.

After the bearings have been installed and allowed to cool, check to ensure that they have not moved out of position in shrinking. If movement has occurred, use a suitably sized sleeve and a press to reposition the bearings. Make certain that they are seated squarely against the shaft shoulders.

If heating the bearings is not practical, use a suitably sized sleeve and an arbor (or hydraulic) press to install the bearings on the shaft.

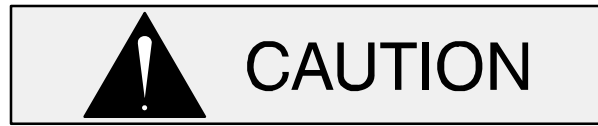

When installing the bearings onto the shaft, **never** press or hit against the outer race, balls, or ball cage. Press **only** on the inner race.

#### Rotor Installation

##### (Figure 1)

Use **fresh** solvent to clean all gasket and O-ring surfaces of the motor housing (47), completely removing any old gasket and cement material. Inspect the sealing surfaces for burrs, nicks and pits which could cause a poor seal. Repair or replace as require.

Use **fresh** solvent to clean the bearing bore of the upper motor housing (47) and install the spring washer (31) in the bore.



**Most cleaning solvents are toxic and flammable. Use them only in a well ventilated area free from excessive heat, sparks, and flame. Read and follow all precautions printed on solvent containers.**

Carefully ease the rotor and assembled bearings into the motor housing (47) and through the stator so that the upper bearing (30) seats squarely in the motor housing bearing bore.

Position the motor bushing (9) in the motor housing so one of the two drain holes is aligned with the motor cavity drain plug (10). Install the intermediate O-ring (11) and lubricate the I.D. of the intermediate bearing bore.

Position the bearing bore of the intermediate (15) over the lower ball bearing (26) and press the intermediate over the bearing until it seats squarely on the motor bushing and the shoulder of the motor housing. Use caution not to cut the O-ring. Use large snap-ring pliers to install the intermediate retaining ring (24).

Refer to **PUMP END REASSEMBLY**, and reassemble the pump end components.

### Terminal Housing And Power Cable Reassembly And Installation

(Figure 2)



The electrical power used to operate this pump is high enough to cause injury or death. Make certain that the control handle on the control box is in the OFF position and locked out, or that the power supply to the control box has been otherwise cut off and locked out, before attempting to open or service the pump assembly. Tag electrical circuits to prevent accidental startup. Obtain the services of a qualified electrician, and refer to the wiring diagram(s) in **INSTALLATION, Section B**, to make electrical connections.

Clean the exterior of the power cable with warm water and mild detergent. Check for obvious physical damage. Check the cable for continuity and insulation resistance (see **Electrical Testing in TROUBLESHOOTING**). Do not attempt repairs except to cut off either end of the cable; **splicing is not recommended**. Reinstall any wire tags or terminals which may have been removed.



**Never attempt to alter the length or repair any power cable with a splice. The pump motor and cable must be completely waterproof. Injury or death may result from alterations.**

Use oil to lightly lubricate the outside of the pump power cable (5), and the bores of the terminal housing (1), terminal cap (2) and gland bushing (6) for ease of assembly. Slide the terminal cap, gland bushing, terminal housing, and terminal plate gasket (15) onto the cable, allowing approximately 3 ft. (1 m) of cable to extend beyond the ter-

minal housing. Temporarily tape the green and yellow (if supplied) ground wires to the cable.

### Sealing Terminal Housing Connections With Silicone Adhesive

(Figure 2)



**Do not attempt to operate this pump unless the power cable leads are properly sealed in the terminal housing. Moisture entering the terminal housing could cause a short circuit, resulting in pump damage and possible serious injury or death to personnel.**

When shipped from the factory, the cable leads and terminals (19) were encapsulated in heat-shrink tubing (13), and bonded to the terminal plate (16) with silicone adhesive to provide a water-tight seal. If this insulating material has been damaged or removed during maintenance, it **must** be replaced using materials and equipment approved by Gorman-Rupp (see the parts list for repair kits).

#### NOTE

*Heat-shrink tubing **must** be used to seal the power and control cable leads to the terminals before bonding the leads to the terminal plate. If silicone adhesive is not available in the field, a commercially available potting kit may be used to bond the connections to the terminal plate. If this alternate sealing method is used, refer to the instructions in **Sealing Terminal Plate Connections With Potting Compound**. Use **only** materials approved by Gorman-Rupp for field repairs.*

Before resealing the power and control cables, remove all the old adhesive material (or potting compound) from the leads, terminals, terminal posts, and terminal plate. Inspect all parts for damage, and replace as required.

#### NOTE

*Clean the cable leads and terminal plate in the areas to be sealed with cleaning solvent. Incomplete sealing will occur if the surfaces are dirt, oil or grease coated.*

Assemble the terminal posts (1), dyna seal washers (16), and lower terminal nuts (6) to the terminal plate as shown in Figure 2.

**NOTE**

*Both the power cable and motor conductor leads should be tinned prior to reassembly.*

Slide a length of heat-shrink tubing (13) up over each of the power cable leads. Install the leads on the terminal posts as shown in Figure 5 and secure them using the hex nuts (14). Slide the tubing down each lead until the terminals are covered and the tubing contacts the terminal plate. The tubing **must** extend up the leads far enough to ensure a good seal.

Carefully heat each tube with a commercially available hot air gun capable of producing 750°F (399°C), and shrink the tubes around the cable leads and terminals.



Use **only** Dow-Corning 737 Silicone Adhesive (see the Parts List Manual for the part number) or potting compound for sealing terminal housing connections. Use of unapproved sealing products will void the pump warranty.

**NOTE**

*Do not use a mold or reservoir with the silicone*

*adhesive.*

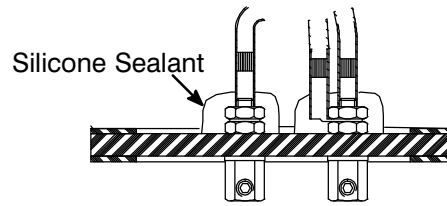

**Figure 4. Silicone Adhesive Sealing**

Check terminal locations for correctness. Apply a 1/4 in. (6,4 mm) thick layer (maximum) of silicone adhesive around each of the terminal posts as shown in Figure 4. Remove any adhesive from gasketed surfaces.



**All air pockets, voids or gaps in the silicone sealant must be removed to ensure a water-tight seal in the terminal housing. Otherwise, moisture entering the terminal housing could cause a short circuit, resulting in pump damage and possible serious injury or death to personnel.**

Allow the adhesive to cure for at least one hour before securing the terminal housing to the motor housing.

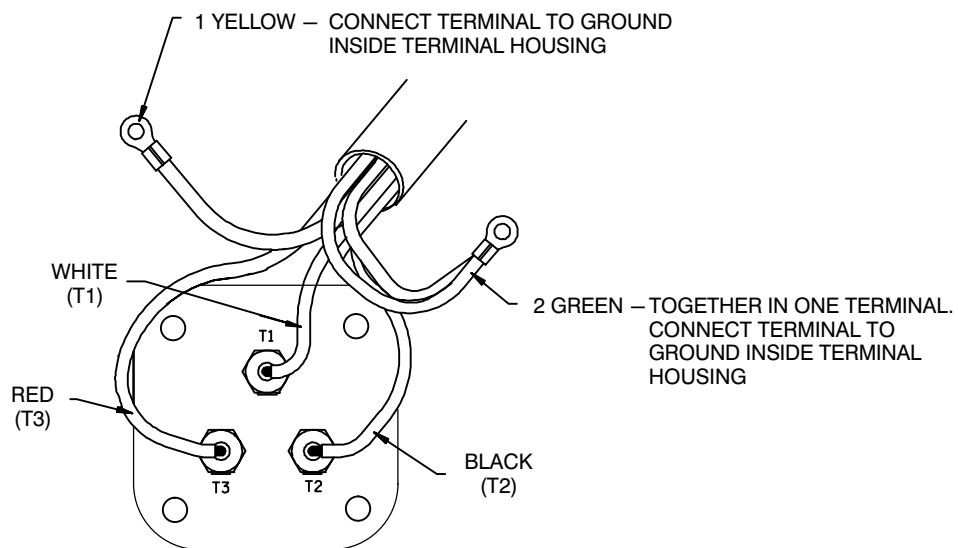

**Figure 5. Terminal Housing Wiring Connections**

## Sealing Terminal Plate Connections With Potting Compound

### (Figure 2)

Potting compound and silicone adhesive have the same electrical properties when correctly applied. Silicone adhesive is used at the factory to facilitate production. A commercially available potting kit (Products Research Corp., part number PR-1201-Q Class 1 potting compound, Chemseal potting compound, part number GS3100, or equivalent) may also be used to seal the connections.

Clean and assemble all terminal components as indicated in **Sealing Terminal Plate With Silicone Adhesive**. Use medium grit sandpaper to prepare the surface of the terminal plate in the area where the potting mold will be installed.

### NOTE

*Clean the cable lead and terminal plate in the areas to be potted with cleaning solvent before potting. Potting compound will not adhere properly to oil or grease coated surfaces.*

Trim the potting mold so it is just long enough to cover the terminal post studs. Slide the potting mold up over the leads of the power cable and control cable.

Secure each cable lead as described in the previous section. Slide the potting mold down over the terminal posts and onto the terminal plate. Hang the cable in a vertical position with the terminal plate horizontal. The cable leads and terminals should be centered in the potting mold. Use quick-setting cement, such as '3-M Weather Seal' to secure the potting mold to the terminal plate.



**Most potting base compounds contain toluene; use adequate ventilation and avoid prolonged breathing of vapors. Most potting accelerators contain lead; avoid ingestion or prolonged contact with the skin. Read and follow all warnings and recommendations accompanying the potting kit.**

See the instructions with the potting kit regarding application life and setting and curing time. Mix the base compound and accelerator and fill the mold until the electrical connections are completely insulated. Tamp the potting material to eliminate air bubbles and ensure the material has completely covered the area around the terminal posts.

### NOTE

*The potting compound must completely cover the terminal posts and lead connections.*

When potting has been completed, leave the terminal plate assembly undisturbed until the potting material has cured. Complete curing usually takes about 24 hours. Curing time can be shortened by using a heat lamp, but be careful not to melt the potting or potting mold, or burn the cable. When the potting material is no longer "tacky" to the touch, it has cured.

## Securing And Insulating Motor Leads Inside Motor Housing

### (Figure 1)

Motor leads for 230/1, 230/3, and 460/3 models **must** be secured with the connector(s) and insulated with heat shrink tubing to ensure correct voltage, and to prevent possible electrical shortage. Secure and insulate the leads as follows.



**Motor voltage leads must be secured with the wire nut connectors and heat shrink tubing. Failure to properly secure and insulate these leads could cause an electrical shortage, resulting in injury or death to personnel.**

### NOTE

*Heat shrink tubing may be heated with a torch or a commercial hot air gun capable of producing 750°F (399°C).*

**230/3 and 1/50/220** – Strip motor leads T4, T5 and T6 about 3/4-inch (19 mm). Join leads T4, T5 and T6, and secure using the wire nut connector

(24). Slide a piece of heat shrink tubing (25) over the connector and shrink the tubing using a commercially available hot air gun capable of producing 750°F (399°C).

**460/3 and 3/50/380** – Strip motor leads T4, T5, T6, T7, T8 and T9 about 3/4-inch (19 mm). Join lead T4 to T7, T5 to T8 and T6 to T9, and secure using the wire nut connectors (24). Slide a piece of heat shrink tubing (25) over each connector and shrink the tubing using a commercially available hot air gun capable of producing 750°F (399°C).

### Terminal Housing Reassembly

#### (Figure 2)

After the terminal housing connections have been sealed, slide the housing down the cable. Untape the ground leads and secure them to the ground terminals with the hardware (7 and 8). **Be sure** the leads make good contact with the housing.

Lubricate the upper bore of the terminal housing, and slide the terminal bushing (6) into place. Slide the terminal cap (2) into place and install the nuts (4). Do not fully tighten the nuts at this time.

### Terminal Housing Installation

#### (Figure 2)

#### NOTE

*A **small** amount of gasket adhesive may be used to hold the upper and lower terminal plate gaskets in place to ease assembly.*

Position the lower terminal plate gasket (17) against the motor housing. Position the terminal housing assembly over the motor housing and, using the voltage and phase instructions below, secure the motor leads to the terminals (19) by tightening the nylock machine screws (7). (The motor leads may be trimmed to length as required.)

**230/3 and 1/50/220** – Connect motor leads T1 and T7 to terminal post T1 (W). Connect motor

leads T2 and T8 to terminal post T2 (B). Connect motor leads T3 and T9 to terminal post T3 (R).

**460/3 and 3/50/380** – Connect motor lead T1 to terminal post T1 (W). Connect motor lead T2 to terminal post T2 (B). Connect motor lead T3 to terminal post T3 (R).

After the wire terminals have been secured, check their locations for correctness.

#### (Figure 1)

Position the terminal housing assembly (5) on the motor housing (47). If required, rotate the terminal housing and twist the motor leads to remove excess slack. Position the cable so it is opposite the pressure relief valve (36) for hoisting bail clearance. Coat the threads of the motor housing studs (19) with 'Never-Seez' or equivalent compound, and secure the terminal housing assembly to the motor housing with the nuts (21); torque the nuts to 11 ft. lbs. (132 in. lbs. or 1,5 m. kg.).

See **FINAL ASSEMBLY** and **VACUUM TESTING** followed by **LUBRICATION**.

### FINAL ASSEMBLY

#### (Figure 1)

If the discharge flange (38) was removed from the motor housing, replace the discharge flange gasket (37). Apply 'Never-Seez' or equivalent compound on the flange studs (39), and secure the flange with the nuts (40).

If the hoisting bail (44) was removed, install the bail bushing (32) and secure the bail to the motor housing with the hardware (33, 34 and 35).

Connect the discharge hose, and reposition the pump. If rigid piping or long hose is used, reposition the pump, then connect the piping.

### VACUUM TESTING

To ensure the water-tight integrity of the pump, it is recommended that the motor and seal cavities be vacuum tested any time the seal(s) and/or motor are serviced.

Drain **all** of the oil from **both** the seal and motor cavities before performing the test. Oil within the

cavities will be drawn into the system, resulting in damage to the vacuum pump or manometer.

Use a manometer with a range of 30 to 0 to 30 inches of mercury to perform the test. **Do not** use a vacuum gauge. Vacuum gauges are not sensitive enough to detect minor leaks.

It is recommended that a vacuum pump be used to draw the vacuum on the cavities. If a vacuum pump is not available, a compressor/venturi system may be used. If the compressor/venturi cannot draw the higher vacuum level shown in Table E-1, draw the motor cavity vacuum down as far as the system will allow, then draw the seal cavity down so the differential between the two cavities is the same as

the differential between the vacuum readings shown in the table.

Install full-closing ball-type shutoff valves with quick-disconnect fittings in the pipe plug holes in both the motor and seal cavities. Test the motor cavity for its full duration first, then use the shutoff valve to maintain the motor cavity vacuum while testing the seal cavity. The motor cavity vacuum **must** be higher than the vacuum in the seal cavity to prevent separation of the seal faces or unseating the stationary seal seat between the seal and motor cavities.

Figure 6 shows a simple schematic for setting up either a vacuum pump or a venturi/compressor test system.

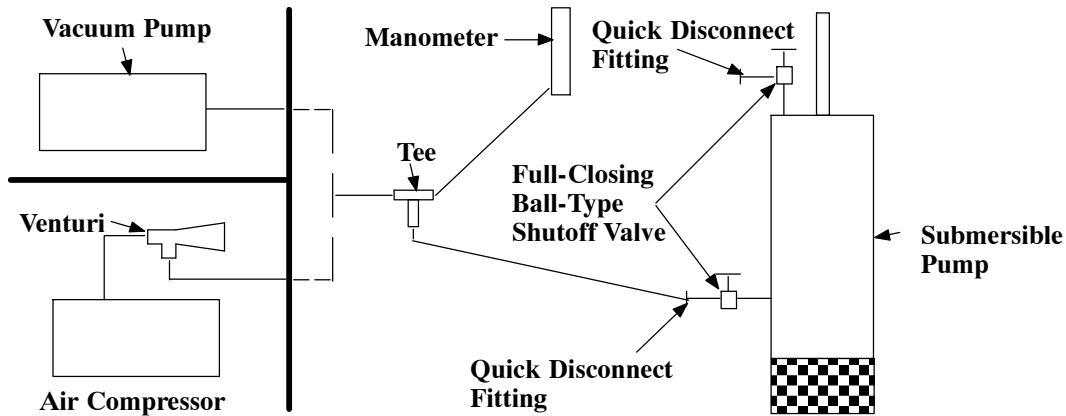

Figure 6. Vacuum Test System

Table E-1 shows the vacuum to be drawn on each cavity, and the duration to maintain each vacuum reading. **Any** change in vacuum reading during

the test indicates a leak which **must** be identified and corrected before putting the pump back into service.

Table E-1. Vacuum Test Data

Pump Model	Motor Cavity Vacuum (In. Hg.)	Duration (Minutes)	Seal Cavity Vacuum (In. Hg.)	Duration (Minutes)
S2B	30	1	20	1

LUBRICATION

Seal Cavity

Check the oil level in the seal cavity before initial startup, after the first two weeks of operation, and every month thereafter.



**Check the oil level only when the pump is cool. If the oil level plug is removed when the pump is hot, pressure in the seal cavity can cause hot oil to be ejected as the plug is removed.**

To check the seal cavity oil, lay the pump on its side and remove the seal cavity plug (13) in the intermediate. Tip the pump and drain off a small amount of oil into a transparent cup. If the oil level is abnormally low, or the color milky or dark, refer to **Draining Oil From Seal Cavity** in this section for instructions and troubleshooting tips. If the oil is clear, apply 'Loctite Pipe Sealant With Teflon No. 592.' or equivalent to the threads of the pipe plug, before reinstalling the plug.

To fill the seal cavity, remove the seal cavity drain/fill plug (13) and add the recommended grade of submersible pump oil. Refer to the **Installation and**

**Operations** Manual for positioning of the pump during filling of the seal cavity. Apply 'Loctite Pipe Sealant With Teflon No. 592.' or equivalent to the threads of the pipe plug, before reinstalling the plug.

See Table E-2 for quantity of lubricant when lubricating a dry (overhauled) pump. See Table E-3 for lubricant specifications.

The grade of lubricant used is critical to the operation of this pump. Use premium quality hydraulic oil as specified in the following table. Oil must be stored in a clean, tightly closed container in a reasonably dry environment.

**Table E-2. Oil Quantity**

Pump Model	Seal Cavity	Motor Cavity
S2B	8 ounces (0,2 liter)	32 ounces (1 liter)

**Table E-3. Pump Oil Specifications**

Specifications:	
Type .....	Premium high viscosity index, anti-wear hydraulic oil
Viscosity (SSU @ 104°F [40°C]) .....	110 to 155
Viscosity (SSU @ 210°F [100°C]) .....	40 to 50
Dielectric .....	26,000 (volts-min)
Recommended supplier:	
Gulf Oil Company .....	Gulf Harmony AW Hydraulic Fluid MG 32
Acceptable alternate suppliers:	
Gulf Oil Company .....	Gulf Harmony 32 AW
Texas Oil Company .....	Rando HD 32 or HD AZ 32
Sun Oil Company .....	Sunvis 816 or 916
BP (Also Boron) .....	Energol-HLP 32
Shell Oil Company .....	Tellus 32, Tellus T-23 or T32
ARCO .....	Duro 32
Exxon (Also Esso) .....	Nuto H 32
Petro-Canada .....	Harmony HVI 22

**Motor Housing Cavity**

With the pump in an upright position, remove the pressure relief valve (36) on the top of the pump. See Table E-2 and add the recommended grade of lubricant to the motor cavity. **Maintain the oil at this level.** Apply 'Loctite Pipe Sealant With Teflon No. 592' or equivalent sealant to the threads of the pipe busing (9). Reinstall and tighten the bushing.



Never attempt to fill the motor cavity through the drain plug (10) opening. A volume of air must be trapped above the motor to permit thermal expansion of the motor oil.

**For Warranty Information, Please Visit  
[www.grpumps.com/warranty](http://www.grpumps.com/warranty)  
or call:  
U.S.: 419-755-1280  
Canada: 519-631-2870  
International: +1-419-755-1352**

**GORMAN-RUPP PUMPS**