

**INSTALLATION, OPERATION,  
AND MAINTENANCE MANUAL**  
WITH PARTS LIST



**S SERIES  
SUBMERSIBLE PUMP**

MODEL
<b>S3A1-E5 230/3</b>
<b>S3A1-E5 460/3</b>
<b>S3A1-E5 575/3</b>

**GORMAN-RUPP PUMPS**

[www.grpumps.com](http://www.grpumps.com)

Register your new  
Gorman-Rupp pump online at  
**www.grpumps.com**

Valid serial number and e-mail address required.

**RECORD YOUR PUMP MODEL AND SERIAL NUMBER**

Please record your pump model and serial number in the spaces provided below. Your Gorman-Rupp distributor needs this information when you require parts or service.

Pump Model: \_\_\_\_\_

Serial Number: \_\_\_\_\_

# TABLE OF CONTENTS

<b>INTRODUCTION</b> .....	<b>PAGE I – 1</b>
<b>SAFETY - SECTION A</b> .....	<b>PAGE A – 1</b>
<b>INSTALLATION – SECTION B</b> .....	<b>PAGE B – 1</b>
GENERAL INFORMATION .....	PAGE B - 1
Pump Model Designation .....	PAGE B - 1
PREINSTALLATION INSPECTION .....	PAGE B - 1
PUMP SEAL .....	PAGE B - 1
LUBRICATION .....	PAGE B - 1
PUMP INSTALLATION .....	PAGE B - 2
Pump Motor Specifications .....	PAGE B - 2
Pump Dimensions .....	PAGE B - 2
Lifting .....	PAGE B - 3
Positioning of Pump .....	PAGE B - 3
Piping .....	PAGE B - 4
ELECTRICAL CONNECTIONS .....	PAGE B - 4
Control Box Installation .....	PAGE B - 5
Dual Voltage Usage .....	PAGE B - 5
Field Wiring Connections (Incoming Power) .....	PAGE B - 5
Grounding Methods .....	PAGE B - 6
Pump Power Cable Connections .....	PAGE B - 7
Control Box Specifications .....	PAGE B - 8
Motor Cable Grounding Test .....	PAGE B - 8
Liquid Level Devices .....	PAGE B - 8
WIRING DIAGRAMS .....	PAGE B - 10
<b>OPERATION – SECTION C</b> .....	<b>PAGE C – 1</b>
PRIMING .....	PAGE C - 1
Hand Primers .....	PAGE C - 1
STARTING .....	PAGE C - 1
OPERATION .....	PAGE C - 2
Leakage .....	PAGE C - 2
Liquid Temperature And Overheating .....	PAGE C - 2
Strainer Check .....	PAGE C - 2
Pump Vacuum Check .....	PAGE C - 2
STOPPING .....	PAGE C - 2
Cold Weather Preservation .....	PAGE C - 2
BEARING TEMPERATURE CHECK .....	PAGE C - 3
<b>TROUBLESHOOTING – SECTION D</b> .....	<b>PAGE D – 1</b>
PREVENTIVE MAINTENANCE .....	PAGE D - 3

**TABLE OF CONTENTS**  
**(continued)**

<b>PUMP MAINTENANCE AND REPAIR - SECTION E .....</b>	<b>PAGE E – 1</b>
STANDARD PERFORMANCE CURVE .....	PAGE E - 1
PARTS LISTS:	
Pump Model .....	PAGE E - 3
Terminal Housing and Cable Assembly .....	PAGE E - 5
PUMP END DISASSEMBLY .....	PAGE E - 6
Strainer Removal .....	PAGE E - 7
Draining Oil From Seal Cavity .....	PAGE E - 7
Draining Oil From Motor Cavity .....	PAGE E - 7
Positioning Pump For Disassembly .....	PAGE E - 7
Suction Head Removal .....	PAGE E - 7
Impeller Removal .....	PAGE E - 7
Diffuser Removal .....	PAGE E - 8
Seal Removal .....	PAGE E - 8
PUMP END REASSEMBLY .....	PAGE E - 8
Cleaning and Inspection of Pump Parts .....	PAGE E - 8
Seal Installation .....	PAGE E - 10
Diffuser Installation .....	PAGE E - 10
Impeller Installation .....	PAGE E - 11
Strainer Plate and Suction Head Installation .....	PAGE E - 11
Impeller Clearance .....	PAGE E - 11
Strainer Installation .....	PAGE E - 11
MOTOR DISASSEMBLY .....	PAGE E - 12
Terminal Housing and Power Cable Removal and Disassembly .....	PAGE E - 12
Intermediate and Rotor Disassembly .....	PAGE E - 13
Bearing Removal .....	PAGE E - 13
Stator Removal .....	PAGE E - 13
Relief Valve .....	PAGE E - 14
Hoisting Bail .....	PAGE E - 14
MOTOR REASSEMBLY .....	PAGE E - 14
Stator Installation .....	PAGE E - 14
Bearing Installation .....	PAGE E - 15
Rotor and Intermediate Installation .....	PAGE E - 16
Terminal Housing and Power Cable Reassembly and Installation .....	PAGE E - 16
Sealing Terminal Housing Connections With Silicone Adhesive .....	PAGE E - 17
Sealing Terminal Plate Connections With Potting Compound .....	PAGE E - 19
Terminal Housing Installation .....	PAGE E - 19
FINAL ASSEMBLY .....	PAGE E - 20
VACUUM / PRESSURE TESTING .....	PAGE E - 20
LUBRICATION .....	PAGE E - 21
Seal Cavity .....	PAGE E - 21
Motor Housing Cavity .....	PAGE E - 22

## INTRODUCTION

**Thank You** for purchasing a Gorman-Rupp pump. **Read this manual** carefully to learn how to safely install and operate your pump. Failure to do so could result in personal injury or damage to the pump.

This manual will alert personnel to known procedures which require special attention, to those which could damage equipment, and to those which could be dangerous to personnel. However, this manual cannot possibly anticipate and provide detailed precautions for every situation that might occur during maintenance of the unit. Therefore, it is the responsibility of the owner/maintenance personnel to ensure that **only** safe, established maintenance procedures are used, and that any procedures not addressed in this manual are performed **only** after establishing that neither personal safety nor pump integrity are compromised by such practices.

If there are any questions regarding the pump or its application which are not covered in this manual or in other literature accompanying this unit, please contact your Gorman-Rupp distributor, or the Gorman-Rupp Company:

**The Gorman-Rupp Company**  
**P.O. Box 1217**  
**Mansfield, Ohio 44901-1217**  
**Phone: (419) 755-1011**  
 or:  
**Gorman-Rupp of Canada Limited**  
**70 Burwell Road**  
**St. Thomas, Ontario N5P 3R7**  
**Phone: (519) 631-2870**

For information or technical assistance on the power source, contact the power source manufacturer's local dealer or representative.

The following are used to alert maintenance personnel to procedures which require special attention, to those which could damage equipment, and to those which could be dangerous to personnel:



**Immediate hazards which WILL result in severe personal injury or death. These instructions describe the procedure required and the injury which will result from failure to follow the procedure.**



**Hazards or unsafe practices which COULD result in severe personal injury or death. These instructions describe the procedure required and the injury which could result from failure to follow the procedure.**



Hazards or unsafe practices which COULD result in minor personal injury or product or property damage. These instructions describe the requirements and the possible damage which could result from failure to follow the procedure.

### NOTE

*Instructions to aid in installation, operation, and maintenance, or which clarify a procedure.*

## SAFETY – SECTION A

This information applies to the S Series submersible motor driven pumps and control boxes.

Because pump installations are seldom identical, this manual cannot possibly provide detailed instructions and precautions for each specific application. Therefore, it is the owner/installer's responsibility to ensure that applications not addressed in this manual are performed only after establishing that neither operator safety nor pump integrity are compromised by the installation.



Before attempting to open or service the pump:

1. Familiarize yourself with this manual.
2. Lock out incoming power to the control box to ensure that the pump will remain inoperative.
3. Allow the pump to completely cool if overheated.
5. Close the discharge valve (if used).



This pump is not designed to pump volatile, explosive, or flammable materials. Do not attempt to pump any liquids for which you pump is not approved, or which may damage the pump or endanger personnel as a result of pump failure. Consult the factory for specific application data.



Before connecting any cable to the control box, be sure to ground the control box. Refer to the Control Box Manual for the suggested grounding methods.



The pump motor is designed to be operated through the control box furnished with the pump. The control box provides overload protection and power control. Do not connect the pump motor directly to the incoming power lines.



The electrical power used to operate this pump is high enough to cause injury or death. Obtain the services of a qualified electrician to make all electrical connections. Make certain that the pump and enclosure are properly grounded; never use gas pipe as an electrical ground. Be sure that the incoming power matches the voltage and phase of the pump and control before connecting the power source. Do not run the pump if the voltage is not within the limits. If the overload unit is tripped during pump operation, correct the problem before restarting the pump.



The electrical power used to operate this pump is high enough to cause injury or death. Make certain that the control handle on the control box is in the OFF

position and locked out, or that the power supply to the control box has been otherwise cut off and locked out, before attempting to open or service the pump assembly. Tag electrical circuits to prevent accidental start-up.



Never attempt to alter the length or repair any power cable with a splice. The pump motor and cable must be completely waterproof. Injury or death may result from alterations.



All electrical connections must be in accordance with The National Electric Code and all local codes. If there is a conflict between the instructions provided and N.E.C. Specifications, N.E.C. Specifications shall take precedence. All electrical equipment supplied with this pump was in conformance with N.E.C. requirements in effect on the date of manufacture. Failure to follow applicable specifications, or substitution of electrical parts not supplied or approved by the manufacturer, can result in severe injury or death and void warranty.



Death or serious personal injury and damage to the pump or components can occur if proper lifting procedures are not observed. Make certain that hoists, chains, slings or cables are in good working condition and of sufficient capacity and that they are positioned so that loads will be balanced

and the pump or components will not be damaged when lifting. Do not attempt to lift this pump by the motor or control cables, or the piping. Attach proper lifting equipment to the lifting bail fitted on the pump. Lift the pump or component only as high as necessary and keep personnel away from suspended objects.



After the pump has been installed, make certain that the pump and all piping or hose connections are secure before operation.



Obtain the services of a qualified electrician to troubleshoot, test and/or service the electrical components of this pump.



Approach the pump cautiously after it has been running. Although the motor is cooled by the liquid being pumped, normal operating temperatures can be high enough to cause burns. The temperature will be especially high if operated against a closed discharge valve. Never operate against a closed discharge valve for long periods of time.



Do not remove plates, covers, gauges, pipe plugs, or fittings from an overheated pump. Vapor pressure within the pump can cause parts being disengaged to be ejected with great force. Al-

low the pump to completely cool before servicing.



Do not attempt to lift the pump by the motor power cable or the piping. Attach proper lifting equipment to the lifting device fitted to the pump. If chains or cable are wrapped around the pump to

lift it, make certain that they are positioned so as not to damage the pump, and so that the load will be balanced.

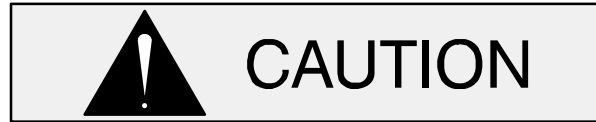

Pumps and related equipment must be installed and operated according to all national, local and industry standards.

## INSTALLATION – SECTION B

### GENERAL INFORMATION

#### Review all SAFETY information in Section A.

Since pump installations are seldom identical, this section is intended only to summarize general recommendations and practices required to inspect, position, and arrange the pump and piping. If there are any questions concerning your specific installation, contact your Gorman-Rupp distributor or the Gorman-Rupp Company.

Liquid level devices are available from Gorman-Rupp as optional equipment. For information on installing and operating these items, refer to the literature accompanying them.

#### Pump Model Designation

Following is a description of the model numbering system for S Series pumps. These submersible pumps are available in a range of sizes. Refer to the following chart to identify the size for your specific pump model.

Pump Model						
S	3	C	1	–	E 6.2	230/3
Series	Discharge Size	Pump Hydraulics	Pump Construction		H.P. (If Shown)	Voltage/Phase

### PREINSTALLATION INSPECTION

The pump assembly was inspected and tested before shipment from the factory. Before installation, check for damage which may have occurred during shipment. Check as follows:

- Inspect the pump assembly for cracks, dents, damaged threads, and other obvious damage.
- Check for loose attaching hardware. Since gaskets tend to shrink after drying, check for loose hardware at the mating surfaces.
- Inspect the power cable for cuts or any other obvious damage.
- Check that amperes, phase, voltage and hertz indicated on the name plate match the

ratings on the control box and incoming power.

- Carefully read all tags, decals, and markings on the pump, and perform all duties indicated.
- Check for oil leaks. If there is any indication of an oil leak, see **LUBRICATION** at the end of this manual.

### PUMP SEAL

S Series pumps utilize one of the following sealing methods.

- There are two shaft seals in the pump. The lower seal prevents liquid from entering the intermediate cavity at the impeller end. The upper seal prevents oil leakage from the motor housing cavity and acts as back-up protection in the event of lower seal failure.
- The pump is equipped with one double-faced seal assembly. It is designed to prevent the liquid being pumped from entering the intermediate cavity at the impeller end, and to prevent moisture from entering the motor housing cavity at the motor end.

Regardless of which sealing method is used, the seal is lubricated by premium quality submersible pump oil.

### LUBRICATION

S series pumps are lubricated in one of the following methods.

- Some pumps utilize two lubrication cavities. The motor housing cavity provides lubrication to the motor assembly and bearings, while the intermediate cavity provides lubrication to the pump seal.
- Some pumps utilize one lubrication cavity, located just behind the seal plate. It is filled with premium quality submersible pump oil which lubricates the pump seal. The motor operates in and is cooled by air, therefore it requires no lubrication.

All S Series pumps are fully lubricated when shipped from the factory. However, lubrication levels **must be checked** before installing the pump

(see **LUBRICATION** in the **MAINTENANCE AND REPAIR MANUAL**). An additional quart (0,9 liter) of oil is provided to “top off” the oil level in the pump motor cavity, if so required. If the oil level is abnormally low, determine the cause before putting the pump into service.

Due to differences in pump design, the quantity of oil and manner in which oil is to be added to the seal cavity varies between pump models. Refer to

Table B-2 for oil capacities and positions for filling the seal cavity in each pump. Motor cavities requiring lubrication should always be positioned vertically for filling. Refer to **LUBRICATION**, Section C for lubrication specifications and intervals.

**PUMP INSTALLATION**

**Pump Motor Specifications**

See following tables for pump specifications.

**Table B-1. Pump Specifications**

Model	Voltage/Phase	Dual Voltage	Pump HP/KW	Motor Speed (RPM)	Full Load Amperes	No Load Amperes	Locked Rotor Amperes	Discharge Size (NPT)
S3A	230/3	YES	5 HP	3450	16	8	65	3 INCH
S3A	460/3	YES	5 HP	3450	8	4	35	3 INCH
S3A	575/3	NO	5 HP	3450	6.5	3.2	28	3 INCH

**Table B-2. Additional Specifications**

Pump Model	Voltage/Phase	Approximate Weight – Lbs. (kg)		Oil Capacity Ounces (Liters)		Seal Cavity Filling Position (H)orizontal (V)ertical *(A)ngle
		Pump	50 Ft. Cable	Seal Cavity	Motor Cavity	
S3A	230/3	55 (25)	18 (8,2)	24 (0,7)	56 (1,7)	A
S3A	460/3	55 (25)	18 (8,2)	24 (0,7)	56 (1,7)	A
S3A	575/3	55 (25)	18 (8,2)	24 (0,7)	56 (1,7)	A

\* Position Pumps at Approximately 30° off Vertical

**Pump Dimensions**

For the approximate physical dimensions of your pump, refer to the pump specification data sheet or contact your Gorman-Rupp distributor or the Gorman-Rupp Company.



**When installing or servicing the pump or controls, follow all requirements for the installation of wiring or electrical equipment as outlined in the National Electric Code. Follow all safety requirements. Failure to observe these require-**

**ments could result in injury or death to personnel.**



**Do not** allow the free end of the power cable to enter the liquid being pumped. The free end of the cable **must** be kept dry to prevent liquid from wicking through the cable and into the motor.

**NOTE**

*Refer to the performance curve in the Parts List Manual when determining the most efficient piping installation. The recommended maximum sub-*

*mergence depth is 65 feet.*

---

### Lifting

Pump unit weights will vary depending on the mounting and drive provided. Check the shipping tag on the unit packaging for the actual weight, and use lifting equipment with appropriate capacity. Drain the pump and remove all customer-installed equipment such as suction and discharge hoses or piping before attempting to lift existing, installed units.

Refer to Table B-2 for the approximate maximum weight for each pump.



**Death or serious personal injury and damage to the pump or components can occur if proper lifting procedures are not observed. Make certain that hoists, chains, slings or cables are in good working condition and of sufficient capacity and that they are positioned so that loads will be balanced and the pump or components will not be damaged when lifting. Do not attempt to lift this pump by the motor or control cables, or the piping. Attach proper lifting equipment to the lifting bail fitted on the pump. Lift the pump or component only as high as necessary and keep personnel away from suspended objects.**



Use **Only Genuine Gorman-Rupp** replacement parts. Failure to do so may create a hazard and damage the pump or diminish optimal pump performance. Any such hazard, damage or diminished performance is not covered by the warranty.

### NOTE

*When appropriate recycling facilities are available, the user should recycle components and fluids when doing any routine maintenance / repairs and also at the end of the pump's useful life. All other components and fluids shall be disposed of according to all applicable codes and regulations.*

---

### Positioning the Pump

### NOTE

*Before installing and operating the pump, check the direction of impeller rotation to ensure that the pump is properly wired at the control box. See **IMPELLER ROTATION**, Section C.*

---

The pump is designed to operate fully or partially submerged. The rotating parts are oil lubricated, and the motor is cooled by a constant flow of liquid or air discharged through internal passages.

As a safeguard against rupture or explosion due to heat, models equipped with oil-lubricated motors are fitted with a pressure relief valve which will open if vapor pressure within the pump motor reaches a critical point.

The pump will operate if positioned on its side, but this is not recommended because the motor torque could cause the pump to roll during operation.

The pump should be independently secured and supported by the lifting device fitted on the pump. If the application involves a lot of debris, protect the pump from excessive wear and clogging by suspending it in a perforated barrel or culvert pipe. If the bottom is heavily sludge-covered, rest the pump on support blocks or suspend it from a raft or similar device near the surface of the liquid. See Figure B-1 for typical pump installations.

All liquid entering the pump must pass through a strainer screen. Any spherical solids which pass through the screen will pass through the pump.

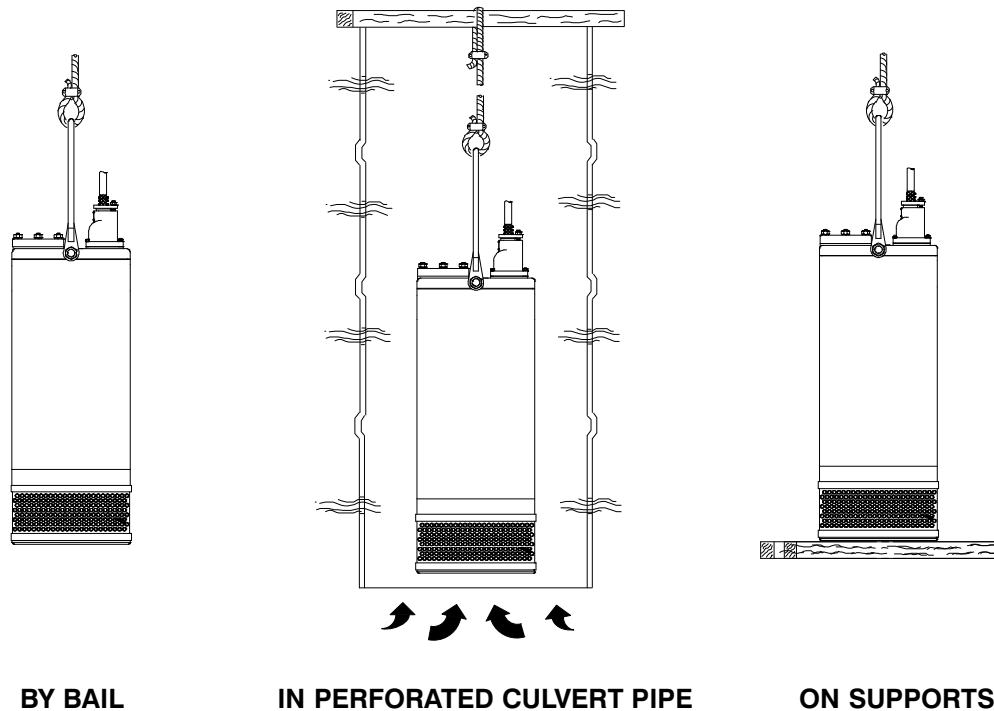

Figure B-1 Typical Pump Installations

### Piping

No suction piping is required in a standard installation.

S Series pumps are provided with a suction strainer to prevent large solids from clogging the impeller. On some models the strainer can be removed and the pump suction “staged” to the discharge of another pump, allowing one pump to feed the other on high discharge head applications.

To determine the size of the discharge connection, see **Table B-1, Pump Specifications**. Either hose or rigid pipe may be used. To facilitate mobility and maintenance, it is recommended that the discharge line be fitted with a quick disconnect fitting near the pump. The discharge line must be independently supported to avoid strain and vibration on the pump.

Either hose or rigid pipe may be used to make discharge connections. For maximum pumping capacity, keep the line as short and straight as possible.

Elbows and fittings used in discharge lines increase friction loss, minimize their use.

It is recommended that a check valve or throttling valve be installed in the discharge line to control siphoning or back flow when the pump is shut off.

### ELECTRICAL CONNECTIONS



**Install and operate this pump in accordance with the National Electrical Code and all local codes. Have a qualified electrician perform all checks and connections in this section.**

**Never attempt to alter the length of the pump motor cable or to repair it with a splice. The power cable and pump motor must be kept completely waterproof. Serious damage to the pump and injury**

or death to personnel can result from any alteration to the cable.

**Control Box Installation**



The pump is designed to be operated through the control box furnished with the pump. The control box provides overload protection and power control. Do not connect the pump motor directly to the incoming power lines.

The control box is a rainproof enclosure with a padlockable front cover. The enclosure is not designed to be watertight, and should not be submerged. Refer to the control box manual for enclosure dimensions and parts.

Secure the control vertically on a level surface, above flood level. The box should be easily accessible to the operator, and located close enough to the pump to avoid excessive voltage drop due to cable length (see **Pump Power Cable Connection**). After the box is installed, make certain the front cover latches properly.



Failure to mount the control box vertically on a level surface may affect operation of the pump controls.

**Dual Voltage Usage**

Some pumps are powered by a dual-voltage motor for utilization with high or low voltage. The motor was originally wired and shipped from the factory for use with the voltage indicated as “Factory Wired” on the pump's name plate. The name plate also indicates the dual voltage pertaining to this motor. If the alternate voltage be utilized, control box modifications and/or certain wiring changes are required.

The control box assembly provided with this pump has been designed to accommodate **only** the voltage indicated on the front of the box. This voltage coincides with the “Factory Wired” voltage of the

motor. If the alternate voltage is utilized, the control box must be replaced with another box designed for the appropriate voltage. Alternate voltage control boxes are shown in the Parts List Manual under Pump Options.



Dual voltage pumps are wired at the factory only for the voltage shown on the name plate. Make certain that the control box voltage matches the pump voltage before using. If the pump voltage is changed, the pump name plate must be changed and a new control box must be installed. Do not run the pump if the voltages do not match; otherwise, the pump warranty will be negated, and damage to the pump, and injury or death to personnel can result.

The motor wiring **must also** be changed before utilizing alternate voltage. For detailed instructions on disassembly and reassembly of the terminal housing, see **Terminal Housing and Power Cable Disassembly** and **Terminal Housing and Power Cable Reassembly** in the Maintenance And Repair manual. Change the motor leads as indicated on the wiring diagram plate affixed to the side of the terminal housing (see Figure B-2). **Be sure** to tag the revised voltage on the pump.

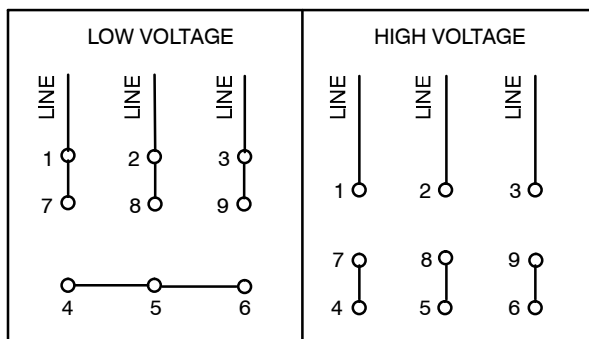

**Field Wiring Connections (Incoming Power)**



The electrical power used to operate this pump is high enough to cause inju-

ry or death. Obtain the services of a qualified electrician to make all electrical connections. Make certain that the pump and enclosure are properly grounded; **never** use gas pipe as an electrical ground. Be sure that the incoming power matches the voltage and phase of the pump and control before connecting the power source. Do not run the pump if the voltage is not within the limits.



Do not connect the pump motor directly to the incoming power lines. The pump motor is designed to operate through a Gorman-Rupp approved control box which provides overload protection and power control; otherwise, the pump warranty will be voided. Make certain that the pump and control box are properly grounded. Install and operate the control box in accordance with the National Electric Code and all local codes. Failure to follow these could result in injury or death to personnel.

Field wiring is **not** provided with the pump, and must be supplied by the user. The field wiring must be of the proper size and type to ensure an adequate voltage supply to the pump. Voltage available **at the motor** must be within the range indicated in Table B-3.

To calculate the voltage available at the motor, proceed as follows:

- a. Measure the voltage across the incoming lines (1 & 2 for single phase, 1 & 2, 2 & 3, and 1 & 3 for three phase) **while the pump is operating at full capacity**. Refer to the literature supplied with the control box for power supply connections.

- b. Next, subtract the motor cable voltage drop (see Table 4, **Pump Power Cable Specifications**).
- c. Do not continue to operate the pump if this voltage is not within the recommended limits. Obtain the services of a qualified electrician to determine the correct field wiring size and other details to ensure an adequate voltage supply to the pump.

Table B-3. Pump Voltage Requirements

NOMINAL VOLTAGE	PHASE	MINIMUM VOLTAGE	MAXIMUM VOLTAGE
115	1	110	120
230	1	220	240
230	3	210	250
460	3	420	500
575	3	520	630
380	3	345	415

Make certain all connections are tight and that cable entry points are rainproof. Support the cable weight, if required, to prevent excessive strain on cable clamps and cable.

#### Grounding Methods

Electrically ground the installation before connecting the field wiring to the control box. Install a grounding terminal to the enclosure and connect it to a properly embedded electrode.

The material used for the electrode **must** be an excellent conductor of electricity, such as copper. If iron or steel is used, it must be galvanized or otherwise metal plated to resist corrosion. **Do not** coat the electrode with any material of poor conductivity, such as paint or plastic.

The electrode must conform to the recommendations of N.E.C. ARTICLE 250. Follow all installation requirements of the N.E.C., and all applicable codes. See Figure B-3 for some suggested grounding methods.

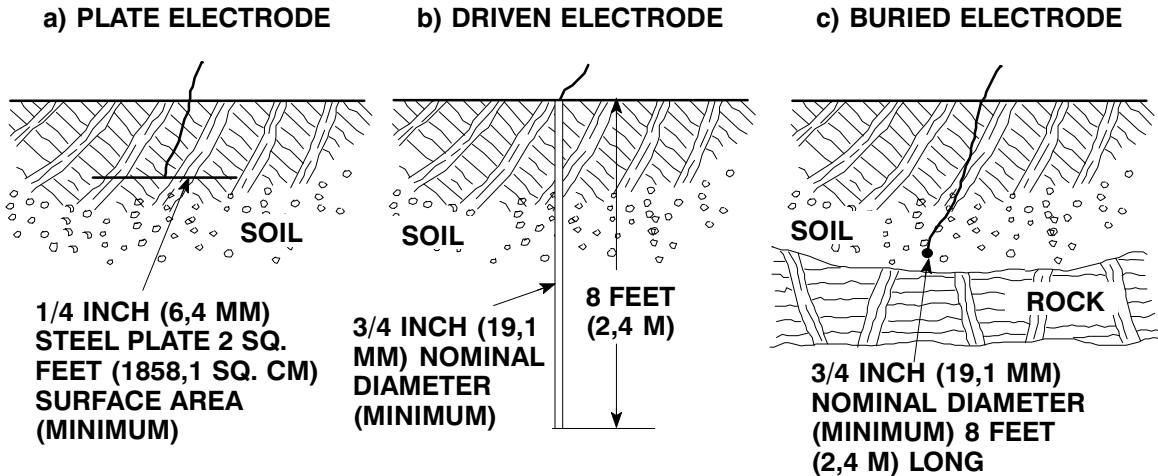

**Figure B-3. Suggested Grounding Methods**

- a. **Plate Electrode:** An iron or steel plate, 1/4 inch (6,4 mm) thick, completely impeded in the ground. The plate must present a surface area of at least 2 square feet (1858,1 sq. cm.).
- b. **Driven Electrode:** A rod or pipe, 3/4 inch (19,1 mm) in diameter minimum, 8 feet (2,4 m) long, completely driven into the ground.
- c. **Buried electrode:** If rock or stone prevents embedding the full 8 foot (2,4 m) length of the ground rod, bury it horizontally in a trench.

Space the ground rod or plates at least 6 feet (1,8) from any other electrode or ground rod, such as those used for signal circuits, radio grounds, lightning rods, etc.

The earth surrounding the ground rod or plate **must** contain enough moisture to make a good electrical connection. In dry or sandy areas, pour water around the rod, or consult qualified personnel to devise a method of improving the connections.



**The electrical power used to operate this pump is high enough to cause injury or death. Make certain that the control box is properly grounded after installation.**

Refer to the literature accompanying the control box for field wiring connections.

**Pump Power Cable Connections**



**The electrical power used to operate this pump is high enough to cause injury or death. Obtain the services of a qualified electrician to make all electrical connections. Make certain that incoming power to the control box is in the OFF position and locked out, or that the power supply to the control box has been otherwise cut off and locked out, before connecting power or accessory cables.**

The pump is provided with a 50 ft. (15,2 m) power cable (see Table B-4 for standard power cable specifications). If a longer cable is required, an optional cable assembly **must** be ordered from the factory. Splicing of the power cable is **not** recommended by the Gorman-Rupp Company due to safety and warranty considerations.



**Never attempt to alter the length or repair any power cable with a splice. The pump motor and cable must be completely waterproof. Injury or death may result from alternations.**

Table B-4. Pump Power Cable Specifications

Pump Model	Voltage/Phase	A.W.G Cable Size	Cable O.D. Inches (mm)	Conductor Dia. Inches (mm)	Amp Rating (See Note Below)	Cable Type	DC Resistance (ohms) at 25°C (77°F) per 1000 ft. (305 m)	Voltage Drop per 100 ft. (30,5m) at Max. Load
S3A	230/3	10	0.75 (19)	.12(3,0)	22.75**	▶ SO	1.11	3.55
S3A	460/3	10	0.75 (19)	.12(3,0)	22.75**	▶ SO	1.11	1.78
S3A	575/3	10	0.75 (19)	.12(3,0)	25*	▶ SO	1.11	1.44

NOTE: \* Amp Rating at 30°C (86°F)  
 \*\* Amp Rating at 40°C (104°F)

▶ Canada Use Type SOW Cable

When necessary to change or connect the pump power cable to the control box, make certain the incoming power is **OFF** and **LOCKED OUT**. Make certain the control box is **PROPERLY GROUNDED** and that the electrical data on the control matches the motor name plate data.

Connect the pump power cable to the control box as shown in the wiring diagrams in the control box manual. Use conduit or cable clamps to secure the power cable to the control box. Make certain that all connections are tight and that cable entry points are rainproof.

#### NOTE

*The power cable furnished with the pump includes three electrical conductors (white, red, and black), two grounding conductors (green) and one ground check conductor (yellow). The yellow ground check lead is used in conjunction with customer-supplied ground monitoring equipment. If this equipment is not used, the yellow lead should be used as a ground conductor.*

#### Control Box Specifications



**Any control box used to operate the pump must be approved by the Gorman-Rupp Company for the application.**

#### Motor Cable Grounding Test



**Do not connect the pump control cable to the control box or incoming voltage before verifying the pump ground; otherwise, personnel will be exposed to serious injury or death.**

Using a volt-ohm meter, connect one lead to the motor cable green/yellow ground lead. Connect the other lead to an **uninsulated** point on the pump body. The test circuit should close.

If the test circuit does not close, there is a defect in the cable or motor which must be corrected.

#### Control Box Connections

This pump is shipped completely wired for the voltage shown on the name plate, and is ready for operation through an approved control box.

Ground and wire the control box in accordance with the instructions accompanying it.

#### NOTE

*For reference, internal motor wiring connections are shown in the Maintenance and Repair manual.*

#### Liquid Level Devices

The standard pump is **not** furnished with a means to automatically regulate liquid level. However, the pump may be controlled to perform filling or dewatering functions by using **either** of the following optional sensing devices (see Figure B-4):

- **Diaphragm Type:** two fixed-position sensors (upper and lower) each contain a diaphragm which flexes with changes in liquid level, thus activating an enclosed miniature switch.
- **Bulb (Float) Type:** a bulb raises or lowers (floats) with the liquid level, thus activating an enclosed miniature switch.

Models under 6 horsepower require an additional control box to incorporate liquid level controls. For models over 6 horsepower, the circuitry may be prewired as a factory option, or easily added to the standard control box in the field by qualified personnel. The unit is complete except for the remote float switches. For installation and operation, see the detailed instructions included with the optional package.



Liquid level devices **must** be positioned far enough apart to allow 10 minutes between starts. If the pump motor cycles more than 6 starts per hour, it will over-heat, resulting in damage to the motor windings or control box components.

Other types of liquid level devices may also be used. Consult the factory for the liquid level device best suited for your application.



If the pump requires liquid level devices, install the liquid level devices and connect them to the control box in accordance with the instructions accompanying the devices.

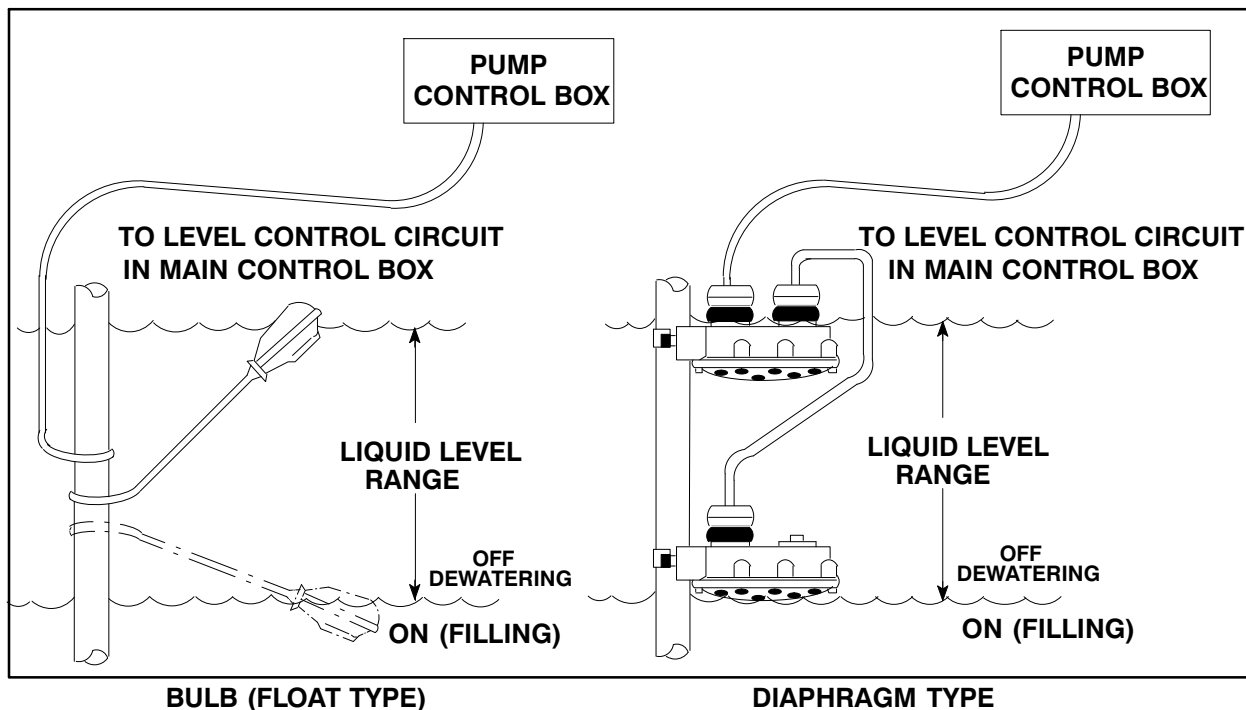

Figure B-4. Liquid Level Devices



The internal wiring of the sensing devices are different for filling and dewatering functions. Be sure to follow the instructions in-

cluded with the option before making wiring connections.

#### **WIRING DIAGRAMS**

Refer to the appropriate wiring diagram in the literature accompanying the control box when making electrical connections.

## OPERATION – SECTION C

Review all **SAFETY** information in Section A.

Follow the instructions on all tags, labels and decals attached to the pump.



**This pump is designed to handle most non-volatile, non-flammable liquids containing specified entrained solids. Do not attempt to pump volatile, corrosive, or flammable liquids which may damage the pump or endanger personnel as a result of pump failure.**

### PRIMING

Install the pump and piping as described in **INSTALLATION**. Make sure that the piping connections are tight, and that the pump is securely mounted. Check that the pump is properly lubricated (see **LUBRICATION** in **MAINTENANCE AND REPAIR**).

This is not a self-priming pump, so an external priming device must be used if the pump is installed on a **suction lift**. A foot valve may be installed at the end of the suction pipe to maintain the prime; however, this may adversely affect pump performance due to friction loss. Many standard centrifugal models are equipped with a hand-operated vacuum pump, exhaust primer, or ejector for this purpose. If a priming device was not furnished with the pump, it may be ordered from the factory as an option.

Before attempting to operate the priming device, close the discharge throttling valve. (Installation of a spring-loaded check valve is also recommended to facilitate priming.) Once the pump is fully primed, close the valve between the priming device and pump to preserve the prime. Start the pump and open the discharge valve slowly to fill the discharge line.



Never operate this pump unless there is liquid in the pump casing. The pump will not prime when dry. Extended operation of a dry pump will destroy the seal assembly.

### Hand Primers

Hand-operated primers are usually mounted on the pump and, when operated, draw air out of the suction line and pump casing. To prime a pump with a hand vacuum pump, open the cock on the pump priming line. Operate the hand pump until liquid flows out of the check valve on the bottom of the primer pump. Once the pump is primed, close the valve located between the primer and the pump so that the prime will not be lost.

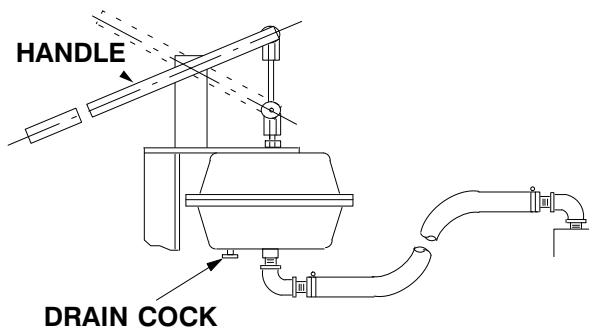

Figure 1. Hand Primer Assembly

### STARTING

Consult the operations manual furnished with the power source.

## OPERATION

### Leakage

No leakage should be visible at pump mating surfaces, or at pump connections or fittings. Keep all line connections and fittings tight to maintain maximum pump efficiency.

### Liquid Temperature And Overheating

The **maximum** liquid temperature for this pump is 160°F (71°C). Do not apply it at a higher operating temperature.

Overheating can occur if operated with the valves in the suction or discharge lines closed. Operating against closed valves could bring the liquid to a boil, build pressure, and cause the pump to rupture or explode. If overheating occurs, stop the pump and allow it to cool before servicing it. Refill the pump casing with cool liquid.



**Allow an over-heated pump to cool before servicing. Do not remove plates, covers, gauges, or fittings from an over-heated pump. Liquid within the pump can reach boiling temperatures, and vapor pressure within the pump can cause parts being disengaged to be ejected with great force. After the pump cools, drain the liquid from the pump by removing the casing drain plug. Use caution when removing the plug to prevent injury to personnel from hot liquid.**

### Strainer Check

If a suction strainer has been shipped with the pump or installed by the user, check the strainer regularly, and clean it as necessary. The strainer should also be checked if pump flow rate begins to drop. If a vacuum suction gauge has been installed, monitor and record the readings regularly to detect strainer blockage.

**Never** introduce air or steam pressure into the pump casing or piping to remove a blockage. This could result in personal injury or damage to the equipment. If backflushing is absolutely necessary, **liquid pressure** must be limited to 50% of the maximum permissible operating pressure shown on the pump performance curve (see Section E, Page 1).

### Pump Vacuum Check

Since this pump does not have a suction check valve, the discharge line must be fitted with a check valve if a pump vacuum reading is to be taken.

With the pump inoperative, install a vacuum gauge in the system, using pipe dope on the threads. Block the suction line and start the pump. At operating speed the pump should pull a vacuum of 20 inches or more of mercury. If it does not, check for air leaks in the seal, gasket, or discharge valve.

Open the suction line, and read the vacuum gauge with the pump primed and at operation speed. Shut off the pump. The vacuum gauge reading will immediately drop proportionate to static suction lift, and should then stabilize. If the vacuum reading falls off rapidly after stabilization, an air leak exists. Before checking for the source of the leak, check the point of installation of the vacuum gauge.

## STOPPING

Never halt the flow of liquid suddenly. If the liquid being pumped is stopped abruptly, damaging shock waves can be transmitted to the pump and piping system. Close all connecting valves slowly.

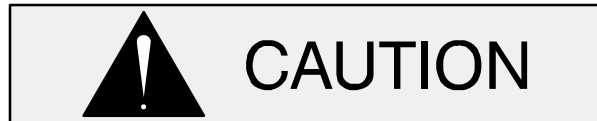

If the application involves a high discharge head, gradually close the discharge throttling valve before stopping the pump.

After stopping the pump, disconnect the power source to ensure that the pump will remain inoperative.

### Cold Weather Preservation

In below freezing conditions, drain the pump to prevent damage from freezing. Also, clean out any

solids by flushing with a hose. Operate the pump for approximately one minute; this will remove any remaining liquid that could freeze the pump rotating parts. If the pump will be idle for more than a few hours, or if it has been pumping liquids containing a large amount of solids, drain the pump, and flush it thoroughly with clean water. To prevent large solids from clogging the drain port and preventing the pump from completely draining, insert a rod or stiff wire in the drain port, and agitate the liquid during the draining process. Clean out any remaining solids by flushing with a hose.

## BEARING TEMPERATURE CHECK

Bearings normally run at higher than ambient temperatures because of heat generated by friction. Temperatures up to 160°F (71°C) are considered

normal for bearings, and they can operate safely to at least 180°F (82°C).

Checking bearing temperatures by hand is inaccurate. Bearing temperatures can be measured accurately by placing a contact-type thermometer against the housing. Record this temperature for future reference.

A sudden increase in bearing temperatures is a warning that the bearings are at the point of failing to operate properly. Make certain that the bearing lubricant is of the proper viscosity and at the correct level (see **LUBRICATION** in Section E). Bearing overheating can also be caused by shaft misalignment and/or excessive vibration.

When pumps are first started, the bearings may seem to run at temperatures above normal. Continued operation should bring the temperatures down to normal levels.

## TROUBLESHOOTING – SECTION D

Review all **SAFETY** information in Section A.



**Before attempting to open or service the pump:**

1. Familiarize yourself with this manual.
2. Lock out or disconnect the power source to ensure that the pump will remain inoperative.
3. Allow the pump to completely cool if overheated.
4. Check the temperature before opening any covers, plates, or plugs.
5. Close the suction and discharge valves.
6. Vent the pump slowly and cautiously.
7. Drain the pump.

TROUBLE	POSSIBLE CAUSE	PROBABLE REMEDY
PUMP FAILS TO PRIME	Air leak in suction line. Lining of suction hose collapsed. Leaking or worn seal or pump gasket.  Suction lift or discharge head too high.  Strainer clogged.  Suction check valve or foot valve clogged or binding.	Correct leak. Replace suction hose. Check pump vacuum. Replace leaking or worn seal or gasket. Check piping installation and install bypass line if needed. See <b>INSTALLATION</b> . Check strainer and clean if necessary. Clean valve.
PUMP STOPS OR FAILS TO DELIVER RATED FLOW OR PRESSURE	Air leak in suction line. Lining of suction hose collapsed. Pump speed too high. Impeller or other wearing parts worn or damaged.  Strainer clogged.	Correct leak. Replace suction hose. Check driver output. Replace worn or damaged parts. Check that impeller is properly centered and rotates freely. Check strainer and clean if necessary.

TROUBLE	POSSIBLE CAUSE	PROBABLE REMEDY
PUMP STOPS OR FAILS TO DELIVER RATED FLOW OR PRESSURE (cont.)	Pump speed too slow.  Impeller clogged. Suction lift too high.  Leaking or worn seal or pump gasket.  Discharge head too high.  Suction intake not submerged at proper level or sump too small.	Check driver output; consult the operation manual.  Free impeller of debris.  Measure lift w/vacuum gauge. Reduce lift and/or friction losses in suction line.  Check pump vacuum. Replace leaking or worn seal or gasket.  Install bypass line.  Check installation and correct submergence as needed.
PUMP REQUIRES TOO MUCH POWER	Pump speed too high. Discharge head too low. Liquid solution too thick.	Check driver output. Adjust discharge valve. Dilute if possible.
PUMP CLOGS FREQUENTLY	Discharge flow too slow.  Suction check valve or foot valve clogged or binding.	Open discharge valve fully to increase flow rate, and run driver at maximum governed speed.  Clean valve.
EXCESSIVE NOISE	Cavitation in pump.  Pumping entrained air.  Pump or drive not securely mounted.  Impeller clogged or damaged.	Reduce suction lift and/or friction losses in suction line. Record vacuum and pressure gauge readings and consult local representative or factory.  Locate and eliminate source of air bubble.  Secure mounting hardware.  Clean out debris; replace damaged parts.
BEARINGS RUN TOO HOT	Bearing temperature is high, but within limits.  Low or incorrect lubricant.  Suction and discharge lines not properly supported.  Drive misaligned.	Check bearing temperature regularly to monitor any increase.  Check for proper type and level of lubricant.  Check piping installation for proper support.  Align drive properly.

### PREVENTIVE MAINTENANCE

Since pump applications are seldom identical, and pump wear is directly affected by such things as the abrasive qualities, pressure and temperature of the liquid being pumped, this section is intended only to provide general recommendations and practices for preventive maintenance. Regardless of the application however, following a routine preventive maintenance schedule will help assure trouble-free performance and long life from your Gorman-Rupp pump. For specific questions concerning your application, contact your Gorman-Rupp distributor or the Gorman-Rupp Company.

Record keeping is an essential component of a good preventive maintenance program. Changes in suction and discharge gauge readings (if so

equipped) between regularly scheduled inspections can indicate problems that can be corrected before system damage or catastrophic failure occurs. The appearance of wearing parts should also be documented at each inspection for comparison as well. Also, if records indicate that a certain part (such as the seal) fails at approximately the same duty cycle, the part can be checked and replaced before failure occurs, reducing unscheduled down time.

For new applications, a first inspection of wearing parts at 250 hours will give insight into the wear rate for your particular application. Subsequent inspections should be performed at the intervals shown on the chart below. Critical applications should be inspected more frequently.

<b>Preventive Maintenance Schedule</b>					
<b>Item</b>	<b>Service Interval*</b>				
	<b>Daily</b>	<b>Weekly</b>	<b>Monthly</b>	<b>Semi-Annually</b>	<b>Annually</b>
General Condition (Temperature, Unusual Noises or Vibrations, Cracks, Leaks, Loose Hardware, Etc.)	I				
Pump Performance (Gauges, Speed, Flow)	I				
Bearing Lubrication		I			R
Seal Lubrication (And Packing Adjustment, If So Equipped)		I			R
V-Belts (If So Equipped)			I		
Air Release Valve Plunger Rod (If So Equipped)			I	C	
Front Impeller Clearance (Wear Plate)				I	
Rear Impeller Clearance (Seal Plate)				I	
Check Valve					I
Pressure Relief Valve (If So Equipped)					C
Pump and Driver Alignment					I
Shaft Deflection					I
Bearings					I
Bearing Housing					I
Piping					I
Driver Lubrication - See Mfgr's Literature					I

**Legend:**  
 I = Inspect, Clean, Adjust, Repair or Replace as Necessary  
 C = Clean  
 R = Replace

\* Service interval based on an intermittent duty cycle equal to approximately 4000 hours annually. Adjust schedule as required for lower or higher duty cycles or extreme operating conditions.

## PUMP MAINTENANCE AND REPAIR - SECTION E

**MAINTENANCE AND REPAIR OF THE WEARING PARTS OF THE PUMP WILL MAINTAIN PEAK OPERATING PERFORMANCE.**

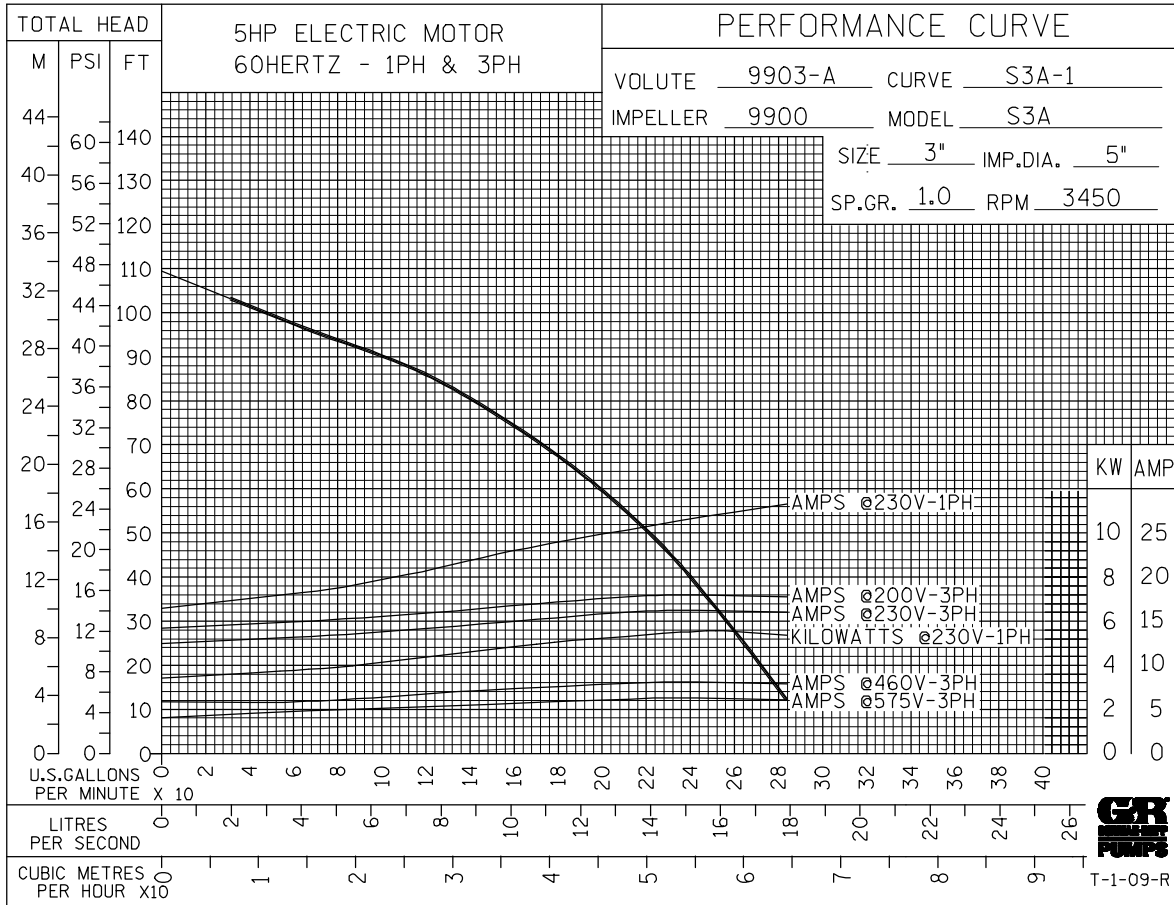

**\* STANDARD PERFORMANCES FOR PUMP MODEL S3A1-E5 230/3, 460/3 & 575/3**

\* Based on 70°F (21°C) clear water at sea level with minimum suction lift. Since pump installations are seldom identical, your performance may be difference due to such factors as viscosity, specific gravity, elevation, temperature, and impeller trim.

Contact the Gorman-Rupp Company to verify performance or part numbers.



**CAUTION**

Pump speed and operating condition points must be within the continuous performance range shown on the curve.

If your pump serial number is followed by an "N", your pump is **NOT** a standard production model.



**PARTS LIST**  
**Pump Model S3A1-E5 230/3, 460/3 & 575/3**  
**(From S/N 1863368 Up)**

If your pump serial number is followed by an "N", your pump is **NOT** a standard production model. Contact the Gorman-Rupp Company to verify part numbers.

ITEM NO.	PART NAME	PART NUMBER	QTY	ITEM NO.	PART NAME	PART NUMBER	QTY
1	DIFFUSER	9903A 11030	1	37 *	O-RING	S1462	1
2	IMPELLER	9900 1101H	1	38	STUD	C0609 17000	6
3 *	SEAL ASSEMBLY	46512-299	1	39	HEX NUT	D06 17000	6
4 *	O-RING	S1462	1	40	LOCK WASHER	J06 17000	6
5 *	GASKET	8743G 20000	1	41	SLEEVE	8742A 17030	1
6	PIPE PLUG	P04 17000	1	42	STRAINER PLATE	8737 13040	1
7	PIPE PLUG	P04 17000	1	43	STRAINER SCREEN	8753 1500V	1
8	INTERMEDIATE BRKT	8743A 13040	1	44	BASE PLATE	8738 13080	1
9 *	BALL BEARING	S1457	1	45	HEX HD CAPSCREW	B0620 15991	4
10 *	GASKET	8430G 20000	1	46	HEX NUT	D06 15991	4
11	MOTOR HOUSING	8430A 13040	1	47	LOCK WASHER	J06 15991	4
12	PIPE PLUG	P04 17000	1	48	STUD	9913 17000	3
13	A HD SET SCREW	GA0603 15990	1	49	WASHER	KB06 17000	3
14	PIPE PLUG	P04 17000	1	50	NYLON LOCK NUT	BC06 17000	3
15	3 WAVE WASHER	S1592	1	51	FLAT WASHER	KB08 17000	1
16 *	O-RING	S1461	1	52	HVY HEX NUT	22561-145	1
17 *	GASKET	7196GA 20000	1	53 *	KEY	N0303-1/2 17000	1
18	STUD	C0606 15991	4	54	SUCTION HEAD ASSY	42111-424	1
19	HEX NUT	D06 15991	4	55	ADJ SHIM SET	2Y 17090	1
20	STUD	C0506 15991	4	56	CONNCECTOR		
21	HEX NUT	D05 15991	4		-230/3	S1718	1
22	LOCK WASHER	J05 15991	4		-460/3	S1718	3
23	HOIST BAIL	9268 1500V	1	57	HEAT-SHRINK TUBE		
24	BUSHING	9562 15991	2		-230/3	31411-235 19450	1
25	HEX HD CAPSCREW	B0804 15991	2		-460/3	31411-235 19450	3
26	LOCK WASHER	J08 15991	2	NOT SHOWN:			
27	FLAT WASHER	KE08 15991	2		CONTROL BOX ASSY		
28	DISCHARGE ELBOW	11357 13040	1		-230/3	48319-116	1
29 *	RELIEF VALVE ASSY	46431-609	1		-460/3	48319-114	1
30	HVY PIPE NIPPLE	THA0406 15079	1		-575/3	48319-119	1
31	TERM HSG & CBL ASSY	47367-041	1		MOTOR PLATE	10436 17000	1
32 *	BALL BEARING	S1458	1		DRIVE SCREW	BM#04-03 17000	4
33	STATOR				SUB PUMP OIL	9568	1
	-230/3 & 460/3	47113-808	1	OPTIONAL:			
	-575/3	47113-809	1		REPAIR GASKET KIT	11000C	1
34 *	ROTOR & SHAFT ASSY	47112-804	1		STAGING ADAPTOR KIT	48272-003	1
35	NAMEPLATE	2613CY 17020	1		LIQUID LEVEL DEVICES:		
36	DRIVE SCREW	BM#04-03 17000	6		DIAPHRAGM TYPE	GRP48-03	1
					FLOAT TYPE	27471-180	1

\* INDICATES PARTS RECOMMENDED FOR STOCK

ILLUSTRATION

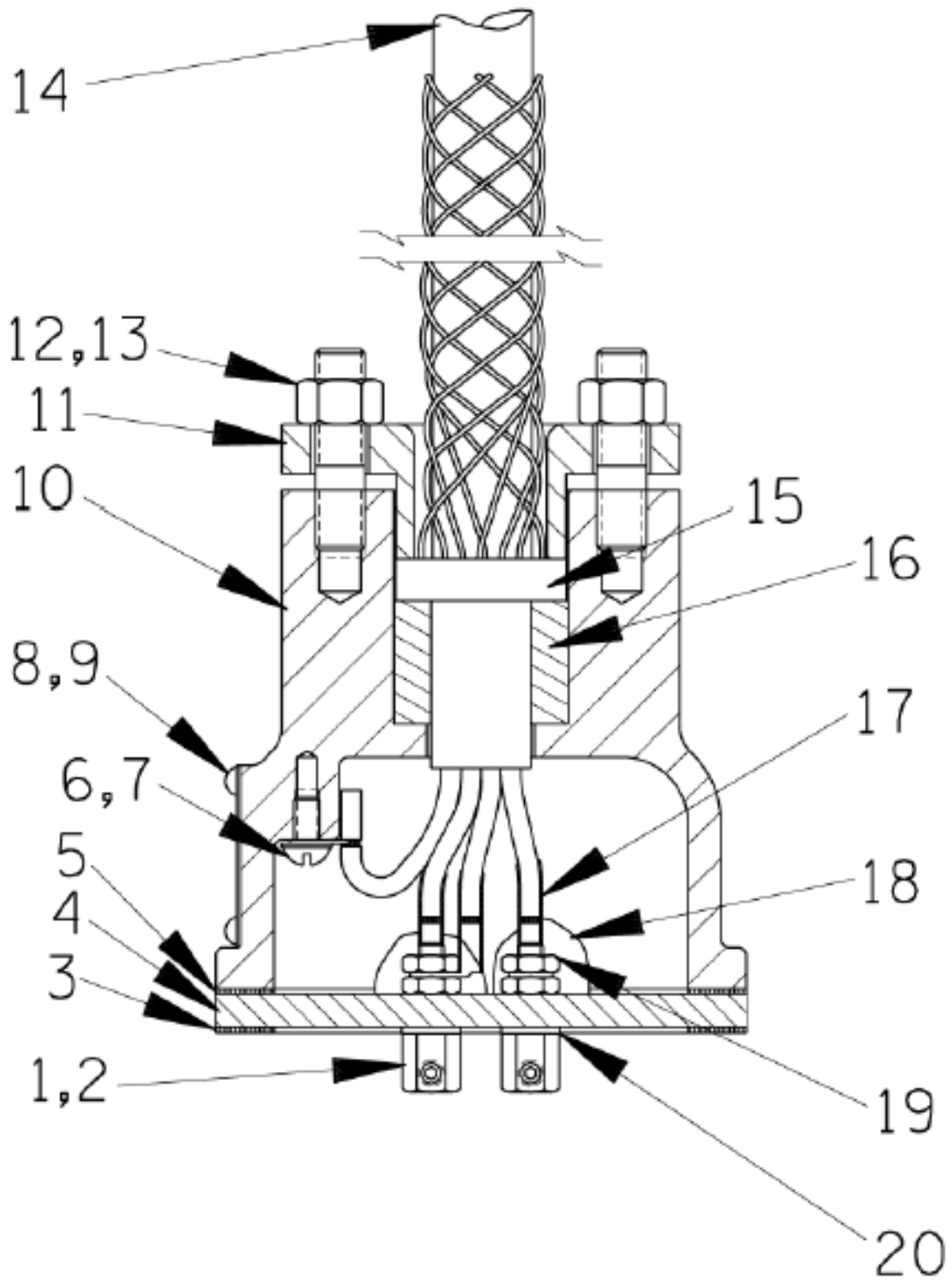

Figure 3. Terminal Housing & Cable Assembly

## PARTS LIST

## Terminal Housing &amp; Cable Assembly

ITEM NO.	PART NAME	PART NUMBER	QTY
1	TERMINAL	11181 14100	3
2	A HD SET SCREW	GA#10-01S 15991	3
3	* GASKET	10321G 20000	1
4	TERMINAL PLATE	10320A 23010	1
5	* GASKET	10321G 20000	1
6	RD HD MACH SCREW	X#10-01-1/2 14990	1
7	T TYPE LOCKWASHER	AK#10 15991	1
8	INFORMATION PLATE	38816-047 17990	1
9	DRIVE SCREW	BM#04-03 17000	4
10	TERMINAL HOUSING	10757 13040	1
11	TERMINAL CAP	10756B 13040	1
12	STUD	C0606 15991	2
13	HEX NUT	D06 15991	2
14	* CABLE ASSEMBLY	9166H	1
15	* CABLE GRIP	11227B	1
16	GLAND BUSHING	10758F 19100	1
17	HEAT-SHRINK TUBE	31411-203 19530	3
18	RTV SEALANT	18771-106	1
19	HEX NUT	D#10 14990	6
20	DYNA-SEAL WASHER	S1590	3

\* INDICATES PARTS RECOMMENDED FOR STOCK

## PUMP END DISASSEMBLY

Review all SAFETY information in Section A.

Follow the instructions on all tags, label and decals attached to the pump.

The following maintenance and repair instructions are keyed to the illustrations (Figures 1 and 2), and the accompanying parts lists. Refer to the Parts List manual for the part number and quantity required.

Before attempting to service the pump or control, terminate the power supply to the control box. Close the discharge throttling valve, if so equipped.



**The electrical power used to operate this pump is high enough to cause injury or death. Make certain that the control handle on the control box is in the off position and locked out, or that the power supply to the control box has been otherwise cut off and locked out, before attempting to open or service the pump assembly. Tag electrical circuits to prevent accidental start-up.**

Use the hoisting bail to remove the pump from the wet well or sump, and move it to a location where the discharge line can be removed. It is not necessary to disconnect a flexible discharge hose before removing the pump. If rigid discharge piping is used, disconnect the piping before attempting to move the pump.



**Do not attempt to lift the pump by the motor power cable or the piping. Attach proper lifting equipment to the lifting device fitted to the pump. If chains or**

**cable are wrapped around the pump to lift it, make certain that they are positioned so as not to damage the pump, and so that the load will be balanced.**

Select a suitable location, preferably indoors, to perform the degree of maintenance required. If the motor housing is to be opened, the work must be done in a clean, well-equipped shop. All maintenance functions must be done by qualified personnel.

Check the chart in **TROUBLESHOOTING**, Section B of this manual, to determine the nature of the pump problem. If the problem is mechanical in nature, such as worn pump parts, seal replacement, lubrication, etc., refer to **PUMP END DISASSEMBLY** for instructions.

If the problem is electrical, complete disassembly may not be required. Refer to **Electrical Testing** in **TROUBLESHOOTING**, Section B, and have a qualified electrician check the control box, cable and terminal housing. If the problem is determined to be in the motor, proceed with **PUMP END DISASSEMBLY**, followed by **MOTOR DISASSEMBLY**. Otherwise, see **Terminal Housing And Power Cable Disassembly**.

Carefully inspect any O-rings or gaskets before removal and cleaning to determine if a proper seal and compression existed prior to disassembly. If sealing was faulty or questionable, the cause must be determined and corrected before reassembly. All gaskets and most O-rings **must** be replaced if disturbed. Repair gaskets and O-rings are listed in the Parts List manual.



**Use Only Genuine Gorman-Rupp replacement parts. Failure to do so may create a hazard and damage the pump or diminish optimal pump performance. Any such hazard, damage or diminished performance is not covered by the warranty.**

**NOTE**

*When appropriate recycling facilities are available, the user should recycle components and fluids when doing any routine maintenance / repairs and also at the end of the pump's useful life. All other components and fluids shall be disposed of according to all applicable codes and regulations.*

**Strainer Removal****(Figure 1)**

To remove the strainer, raise the pump slightly, or lay it on its side and disengage the hardware (45, 46 and 47). Remove the base plate (44), screen (43) and strainer plate (42). Remove and discard the strainer plate gasket (5).

**Draining Oil From Seal Cavity****(Figure 1)**

If any further disassembly is to be performed on the pump, the seal oil cavity must be drained.



Let the pump cool before removing the seal cavity drain plug. Pressure built up within a hot pump could cause the oil to spray out when the plug is removed. Remove the plug slowly and permit pressure to vent to atmosphere.

Lay the pump on its side with the pipe plugs (6 and 7) facing up. Clean any dirt from around the plugs. Remove the seal cavity drain plug (6), and install a short 1/4-inch NPT nipple in the hole. Tip the pump and drain the seal oil into a **clean** container. Inspect the oil for water, dirt, or cloudy condition which could indicate lower seal failure or poor gasket seal.

**Draining Oil From Motor Cavity****(Figure 1)**

If motor problems are suspected, remove the motor cavity drain plug (7), and install a short nipple in the hole. Tip the pump and drain the motor oil into a **clean** container. Inspect the oil for dark color which could indicate motor overheating, water or dirt contamination. The presence of dirt or water could indicate a breakdown in the waterproof integrity of the motor cavity, probably due to poor gaskets or seals.

**Positioning Pump For Disassembly****(Figure 1)**

It is recommended that the pump be positioned upside-down during disassembly. To hold the pump in the inverted position, screw a pipe in the discharge elbow (28) and clamp it in a large vise or rest the pump securely on blocks. Be careful not to damage the pressure relief valve (29) and the terminal housing and cable assembly (31) while in this position. Use adequate equipment and personnel to safely handle the pump until it is secured. If inverting the pump is not practical, lay the pump on its side and secure it to prevent rolling.

**Suction Head Removal****(Figure 1)**

Remove the hardware (49 and 50) and separate the suction head (54) from the intermediate (8). If the impeller (2) is clogged, the debris can usually be removed without further disassembly.

**Impeller Removal****(Figure 1)**

Wedge a block of wood between the vanes of the impeller (2) and the intermediate studs (38) to prevent impeller rotation. Remove the impeller nut (52) and washer (51). Remove the piece of wood from between the vanes of the impeller.

Install the impeller puller (supplied with the pump) and pull the impeller from the rotor shaft. Retain the impeller key (53). Inspect the impeller for wear or damage and replace as required.

Remove the impeller adjusting shims (55). Tie and tag the shims or measure and record their thickness for ease of reassembly.

### Diffuser Removal

(Figure 1)



The lower stationary portion of the seal assembly (3) will be removed with the diffuser (1). Use caution not to chip or damage the seal face.

Carefully slide the diffuser (1) and lower stationary portion of the seal assembly off the shaft as a unit. Carefully press the seal seat element and O-ring from the diffuser bore.

Remove and discard the intermediate O-ring (4). Remove the studs (47) securing the diffuser (1) to the intermediate (8), and remove the diffuser. Use caution when removing the diffuser; tension of the seal spring will be released. Remove and discard the intermediate O-ring (4).

If no further disassembly is required, proceed to the appropriate areas in **PUMP END REASSEMBLY**.

### Seal Removal

(Figures 1 and 3)

The seal used in this pump has two rotating elements, two stationary elements, and two bellows assemblies. The mating faces of the rotating and stationary elements are precision finished and subject to wear. The complete seal should be replaced with each overhaul to ensure trouble-free operation. However, if the old seal must be reused, wrap the seal faces individually in tissue paper to prevent damage to the sealing surfaces.

With the diffuser and lower stationary portion of the seal removed, carefully slide the shaft sleeve (41) and rotating seal components off the shaft as a single unit.

Lubricate the exposed portions of the sleeve and work oil under both bellows assemblies. Pull the lower bellows assembly off the shaft sleeve and remove the seal spring. Pull the upper bellows assembly off the shaft sleeve.

Slide two stiff wires with hooked ends along the shaft and under the upper stationary element. Hook the back side of the element and pull it out of the intermediate bore.

Remove and discard the shaft sleeve O-ring (16).

If no further disassembly is required, proceed to the appropriate areas in **PUMP END REASSEMBLY**.

### NOTE

*Do not disassemble the motor unless it is necessary and a clean, well-equipped shop is available. If the motor housing components are to be serviced, see **MOTOR DISASSEMBLY** in this section. Do not reassemble the end components at this time.*

## PUMP END REASSEMBLY

### NOTE

*Reuse of old O-rings, gaskets, or shaft seal parts will result in premature leakage or reduced pump performance. It is strongly recommended that new gaskets and shaft seal assemblies be used during reassembly (see the parts lists for numbers).*

### Cleaning And Inspection Of Pump Parts

(Figure 1)

With the pump inverted, stuff a clean tissue into the stationary seal seat bore of the intermediate (8) or wrap a small rag around the shaft to prevent foreign material from entering the motor cavity.

Carefully inspect any O-rings or gaskets before removal and cleaning to determine if a proper seal and compression existed prior to disassembly. If sealing was faulty or questionable, the cause must be determined and corrected before reassembly. Replace any parts as required.

Thoroughly clean all reuseable parts with a soft cloth soaked in cleaning solvent. Remove all O-

rings and gaskets, and clean the sealing surfaces of dirt or gasket material. Be careful not to scratch gasket surfaces.



**Most cleaning solvents are toxic and flammable. Use them only in a well ventilated area free from excessive heat, sparks, and flame. Read and follow all precautions printed on solvent containers.**

Inspect the rotor shaft (34) for damaged threads, scoring, or nicks. Remove nicks and burrs with a fine file or emery cloth to restore original contours. If the shaft is bent or severely damaged, the rotor and shaft must be replaced as an assembly (see **MOTOR DISASSEMBLY**).

The shaft seal assembly should not be reused because wear patterns on the finished faces cannot be realigned during reassembly. This could result in premature failure. If necessary to reuse an old seal in an **emergency, carefully** wash all metallic parts in fresh cleaning solvent and allow to dry thoroughly.

Handle the seal parts with extreme care to prevent damage. Be careful not to contaminate the precision finished faces; even fingerprints on the faces can shorten seal life. If necessary, clean the faces with a non-oil based solvent and a clean, lint-free tissue. Wipe **lightly** in a circular pattern to avoid scratching the faces.

Inspect the seal components for wear, scoring, grooves, and other damage that might cause leakage. If any components are worn, replace the complete seal; **never mix old and new seal parts.**

Install the shaft seal as illustrated in Figure 3.

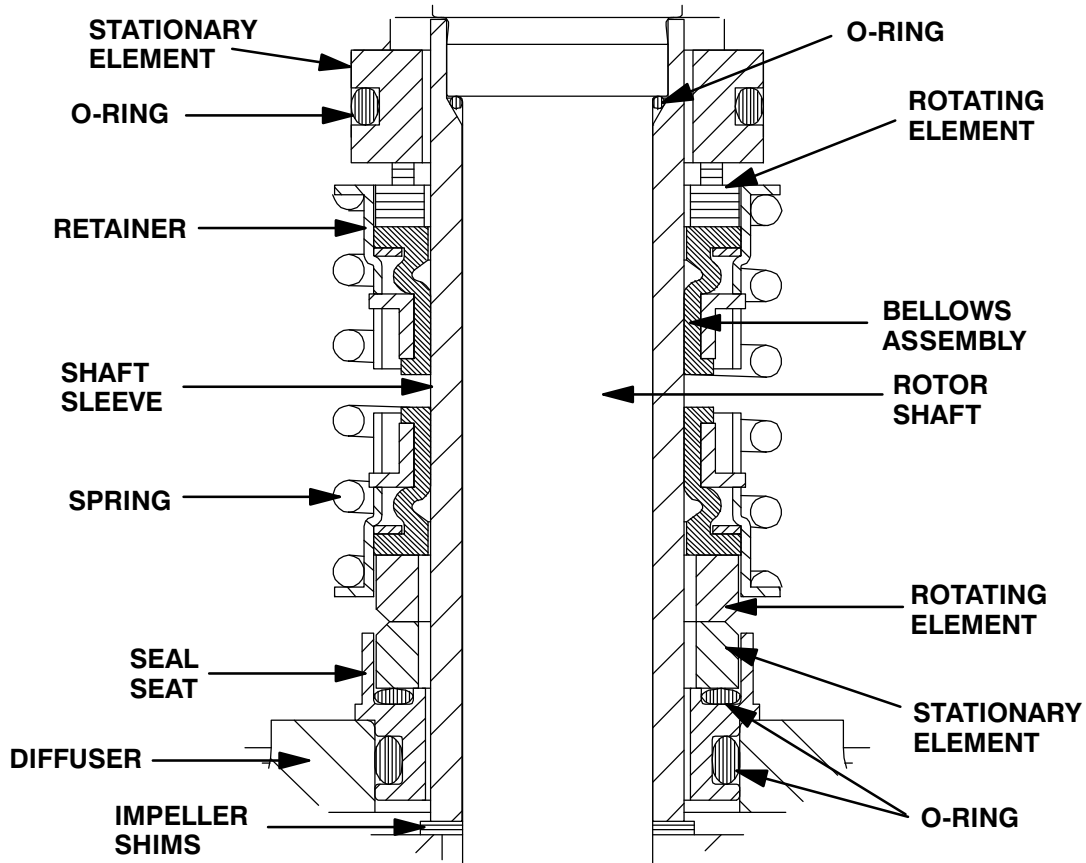

**Figure 3. Seal Assembly**

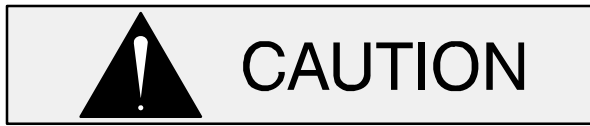

This seal is not designed for operation at temperatures above 122° F (50° C). Do not use at higher operating temperatures.

### Seal Installation

(Figures 1 and 3)

**Do not** unwrap a new seal assembly until time of installation. Cleanliness of seal components is critical, especially the seal faces.

Clean the rotor shaft (34) and seal cavity area of the intermediate (8). Be sure the area is dry and free of lint and dirt. Check the seal bore for burrs or nicks that might prevent a good seal. Remove them with a fine file or emery cloth to restore original contours. If the shaft is bent or damaged, the complete rotor and shaft must be replaced as an assembly. Apply a **light** coating of oil to the bore of the intermediate.

Carefully remove the material stuffed into the seat bore (or unwrap the shaft). **Be sure** no debris stopped by the material falls into the seal cavity.

Clean and inspect the shaft sleeve (41). Replace it if badly scored, or if cut or nicked on the ends. Apply a light coating of oil to the shaft sleeve.

Apply a light coating of oil to the O-ring (16) and install it on the rotor shaft.

Unpack the upper stationary element. Apply a light coating of oil to the O-ring O.D.. Keep the sealing face dry.

### NOTE

*When pressing seal components onto the impeller shaft, use hand pressure only. A push tube cut from a length of plastic pipe will aid in installing seal components. The I.D. of the push tube should be approximately the same as the I.D. of the seal spring.*

Unpack the upper rotating portion of the seal. Be certain the seal face of the rotating element is free of grit or surface damage. Because the rotating

element may not stay in the bellows retainer when turned upside down, place a **small** amount of grease at equal spaces on the back of the element and position it in the bellows retainer. The grease should hold the element in position until the seal is installed. Assemble the drive grooves of the rotating element into the drive lugs of the bellows retainer.

Slide the upper seal rotating portion onto the lubricated shaft sleeve with the seal face toward the stepped end. Apply firm, steady pressure on the seal retainer until it slides down the sleeve. Inspect the seal face to ensure that it is clean and dry. If cleaning is necessary, use a clean tissue to wipe in a concentric pattern.

Install the seal spring.

Unpack the lower seal rotating element and follow the same inspection procedure as for the upper rotating element. Place a clean tissue over the seal face, and press the rotating element onto the shaft sleeve with seal face away from the stepped end. Remove the tissue and inspect the seal face to ensure that it is clean and dry. If cleaning is necessary, use clean tissue to wipe in a concentric pattern.

Slide the sleeve and assembled rotating seal assemblies onto the rotor shaft until the upper seal faces contact. Continue to push the sleeve through the seal until the stepped end of the sleeve fits over the shaft shoulder.

### NOTE

*The seal spring will not fully compress until the diffuser (1) is installed.*

Inspect the diffuser (1) for cracks, distortion, and erosion. Replace it if defective.

Unpack the stationary portion of the lower seal assembly. Be certain the seal face is free of grit or surface damage. Protect the seal face with a clean tissue.

Lubricate the lower seal seat O-ring O.D. and position the seat assembly in the diffuser bore. Apply firm steady pressure until the stepped portion of the seat rests firmly against the diffuser. Make sure

the O-ring is properly positioned and has not been cut. Remove the tissue and wipe the face.

### Diffuser Installation

#### (Figure 1)

Replace the intermediate O-ring (4)

With the seal seat and stationary element installed, carefully lower the diffuser (1) over the shaft until the stationary element mates with the rotating element. Secure the diffuser with the special studs (48).



Do not overtighten the special intermediate studs. Overtightening may cause the threads in the intermediate to strip out.

### Impeller Installation

#### (Figure 1)

Inspect the impeller (2) for cracks, broken vanes, or wear from erosion, and replace it if damaged. Clean the threads on the rotor shaft to remove any old thread locking material. Be sure the impeller bore and the shaft are free of oily film and completely dry.

Install the same thickness of impeller adjusting shims (55) as previously removed. Install the impeller key (53). Align the keyway of the impeller (2) and push the impeller onto the shaft until seated firmly against the shim set. Install the impeller washer (51) on the rotor shaft (34).

**After** the impeller is installed, coat the threads of the rotor shaft with 'Loctite Threadlocker No. 242' or equivalent compound. Install the impeller nut (51). Wedge a block of wood between the vanes of the impeller and intermediate studs (48) to prevent shaft rotation, and torque the nut to 60 ft. lbs. (720 in. lbs. or 8,3 m. kg.).

### NOTE

*The clearance between the face of the impeller and the suction head can only be measured after the impeller and suction head are fully installed.*

Remove the block of wood and turn the impeller to check for free rotation.

### NOTE

*After the impeller has been properly positioned, check for free rotation. Correct any scraping or binding before further reassembly.*

### Strainer Plate And Suction Head Installation

#### (Figure 1)

Thoroughly clean the strainer plate (42) and suction head (54). Inspect the parts for cracks, distortion or erosion, and replace if defective. It must be clean and free of any flaws which could prevent a good seal.

Position the suction head on the studs (48). After the impeller clearance is checked (see **Impeller Clearance**), apply 'NeverSeez' or equivalent compound to the threads of the studs. Install the special washers (49) over the studs with the flat edge toward the outer diameter of the suction head. Secure the suction head by torquing the hex nuts (50) evenly in a cross sequence to 20 ft. lbs. (240 in. lbs. or 2,8 m. kg.).

Install the strainer plate gasket (5). Install the strainer plate around the suction head. Align the holes for the capscrews (45) in the strainer plate with those in the intermediate (8).

### Impeller Clearance

#### (Figure 1)

For maximum pump efficiency, there should be a clearance of .003 to .010 inch (0,07 to 0,25 mm) between the suction head and the face of the impeller. Use a feeler gauge to measure this clearance. If the clearance is not within the specified limits, remove the suction head and impeller. Add or remove adjusting shims (55) as required. Install the impeller and suction head and recheck impeller clearance.

## Strainer Installation

### (Figure 1)

Inspect the strainer screen (43) for cracks, distortion, erosion or broken welds, and replace it if defective. Straighten or weld as required.

Carefully position the strainer screen on the strainer plate (42). Install the base plate (44) on the strainer screen aligning the bolt holes. Secure the strainer assembly using the hardware (45, 46 and 47). Make certain that the strainer screen and base plate seats properly against the shoulder of the strainer plate.

See **LUBRICATION** and **FINAL ASSEMBLY** before putting the pump back into service.

## MOTOR DISASSEMBLY

Disassembly of the motor is rarely required except to replace the motor rotor, stator or bearings. Do not disassemble the motor unless it is necessary and a clean, well-equipped shop is available.

### NOTE

*It is recommended that a pump with a defective motor be returned to Gorman-Rupp, or to one of the Gorman-Rupp authorized Submersible Repair Centers.*



**The electrical power used to operate this pump is high enough to cause injury or death. Make certain that the control handle on the control box is in the off position and locked out, or that the power supply to the control box has been otherwise cut off and locked out, before attempting to open or service the pump assembly. Tag electrical circuits to prevent accidental start-up.**

Carefully inspect any O-rings or gaskets before removal and cleaning to determine if a proper seal and compression existed prior to disassembly. If sealing was faulty or questionable, the cause must

be determined and corrected before reassembly. Replace any parts as required.

## Terminal Housing And Power Cable Removal And Disassembly

### (Figure 1)

Total disassembly of the terminal housing and power cable assembly (31) is not always required. Disassemble and replace **only** the parts proven defective by inspection or testing. See **Electrical Testing** in **TROUBLESHOOTING**.

The terminal housing and power cable assembly may be serviced without disassembling the motor housing or pump end or without draining the oil from the motor cavity. However, the oil **must** be drained before attempting to disassemble the motor housing and components.

Secure the pump in an upright position. Remove the hardware (21 and 22) securing the terminal housing and power cable assembly to the motor housing (11).

### (Figure 2)

Carefully raise the terminal housing (10) from the motor housing until the terminals (1) are accessible. Loosen the allen head setscrews (2), and disconnect the motor leads from the terminal posts. Separate the terminal housing and power cable assembly from the motor housing.

No further disassembly is required to test the stator or power cable.

To disconnect the power cable (14), remove the cable grip assembly (15) securing the power cable (14) to the terminal housing (10).

Push approximately 6 inches (152 mm) of the power cable into the terminal housing so that the terminal plate (4) comes free of the terminal housing. This should permit access to the power cable connections in the terminal plate.

### NOTE

*Do not remove the heat shrink tubing from the power cable leads unless the power cable or terminals require replacement. If replacement is required, the connections between the power cable leads and the terminals **must be** sealed with heat shrink tubing before applying the silicone adhesive (see*

### Terminal Housing And Power Cable Reassembly).

To disconnect the power cable (14) from the terminal housing, pull the terminal plate (4) away from the terminal housing. When shipped from the factory, the connections between the power cable leads and the terminal posts (1) were encapsulated in heat-shrink tubing (17) and bonded to the terminal plate with silicone adhesive (not shown). (In service, the adhesive may have been replaced by potting compound during previous repair.) If damage is extensive and the terminal plate and terminals are to be replaced, simply cut the power cable leads above the terminal collars and heat-shrink tubing, and discard the terminal plate and terminals.

If damage is not extensive and it is necessary to replace the terminal plate or terminal components, carefully cut away the tubing and adhesive. Disconnect the power cable leads from the terminal posts, and separate the terminal plate from the terminal housing (10). Unscrew the hex nuts (19), and remove the terminal posts and dyna seal washers (20) from the terminal plate. Remove and discard the terminal plate gaskets (3 and 5).

Remove the hardware (6 and 7) securing the green and yellow ground leads to the terminal housing. Reinstall the hardware.

See **Terminal Housing/Power Cable Reassembly** if no further disassembly is required.

### Intermediate And Rotor Disassembly

(Figure 1)

See **PUMP END DISASSEMBLY**, and remove all pump end and seal components.

With the pump end disassembled and the motor cavity drained of oil, secure the pump in an inverted position. Remove the hardware (39 and 40) securing the motor housing (11) to the intermediate (8). If necessary, tap around the parting surfaces with a soft-faced mallet to break the seal between the intermediate and motor housing. Remove the intermediate and discard the motor housing gasket (10) and O-ring (37).

Use caution to prevent the rotor (34) from falling on the stator windings. Carefully pull the rotor and assembled bearings (9 and 32) from the motor housing. Reach into the motor housing and remove the wave washer (15) from the upper bearing bore.

Cover the motor housing with a clean, lint free cloth to avoid contamination by dirt or other foreign material.

### Bearing Removal

(Figure 1)



To prevent damage during removal from the shaft, it is recommended that bearings be cleaned and inspected **in place**. It is **strongly** recommended that the bearings be replaced **any** time the shaft and rotor assembly is removed.

Before removing the bearings from the rotor shaft, clean and inspect the bearings **in place** as follows.

Clean the bearings thoroughly in **fresh** cleaning solvent. Dry the bearings with filtered compressed air and coat with light oil.



**Most cleaning solvents are toxic and flammable. Use them only in a well ventilated area; free from excessive heat, sparks, and flame. Read and follow all precautions printed on solvent containers.**

Rotate the bearings by hand to check for roughness or binding and inspect the bearing balls. If rotation is rough or the bearing balls discolored, replace the bearings.

The bearing tolerances provide a tight press fit onto the shaft and a snug slip fit into the motor housing and bearing bore. Replace the shaft and rotor (as an assembly), the motor housing or intermediate if the proper bearing fit is not achieved.

If replacement is required, use a bearing puller to remove the upper and lower ball bearings from the rotor shaft.

## Stator Removal

### (Figure 1)

Do not remove the stator (33) unless it is defective (open windings, insulation resistance low, or stator core damaged). If the stator must be removed, remove the terminal housing as indicated in **Terminal Housing And Power Cable Disassembly**.

Remove the pipe plug (12) located in the motor housing, and loosen the allen head setscrew (13) located underneath the pipe plug.

Position an expandable tool, such as a split disc, approximately 2 inches (51 mm) inside the stator, and expand it tightly and squarely on the I.D. Attach a lifting device to the lifting eye of the tool, and raise the assembly approximately 1 inch (25 mm) off the work surface. Take care not to damage the stator end turns.

The motor housing (11) must be heated with a torch to expand it enough for the stator to be removed. Apply heat evenly to the outside of the motor housing; excessive heat is not required. Use a soft-faced mallet to rap alternate edges of the motor housing, and “walk” the stator out. Continue this process until the stator clears the motor housing.



Take care not to damage the stator end turns during removal from the motor housing.

After the stator has been removed, wrap it in clean, dry rags or other suitable material until reassembly. The stator **must** be kept clean and dry. When handling the stator, **do not** set it on the end windings; lay it on its side.



Do not attempt to rewind the stator. Winding tolerances and materials are closely controlled by the manufacturer, and any deviation can cause damage or operating problems. Replace the stator, or return it to

one of The Gorman-Rupp Authorized Submersible Repair Centers or The Gorman-Rupp factory, if defective.

## Relief Valve

### (Figure 1)

It is recommended that the relief valve assembly (29) be replaced at each overhaul, or at any time the pump motor overheats and activates the valve. Never replace this valve with a substitute which has not been specified or provided by the Gorman-Rupp Company.

It is not necessary to remove the heavy pipe nipple (30) to remove the relief valve assembly. If the pipe nipple is removed, apply `Loctite Retaining Compound No. 620 or 680' or equivalent compound to the pipe nipple threads in the motor housing **only**.

When installing the relief valve, use `Loctite Pipe Sealant With Teflon No. 592' or equivalent compound on the threads. Position the valve out of the way, next to the terminal housing (10, Figure 2) so there is enough room for the terminal housing to clear.

## Hoisting Bail

### (Figure 1)

If the hoisting bail (23) requires replacement, remove the hardware (25, 26 and 27) securing the bail to the motor housing (11). Remove the bushings (24).

## MOTOR REASSEMBLY



Do not attempt to rewind the stator. Winding tolerances and materials are closely controlled by the manufacturer, and any deviation can cause damage or operating problems. Replace the stator, or return it to one of The Gorman-Rupp Authorized Submersible Repair Centers or The Gorman-Rupp factory, if defective.

### NOTE

*Reuse of old O-rings, gaskets, shaft seal parts will*

result in premature leakage or reduce pump performance. It is strongly recommended that new gaskets and shaft seal assemblies be used during reassembly (see the parts lists for numbers).

## Stator Installation

(Figure 1)

### NOTE

Stator installation involves heating the motor housing. This process must be done quickly. Therefore it is recommended that these steps be performed by two people to promote efficient installation of the stator.

Clean all gasket and O-ring surfaces of the motor housing (11), completely removing any old gasket and cement material. Inspect the sealing surfaces for burrs, nicks and pits which could cause a poor seal, and replace defective parts as required.

Thoroughly clean the inside of the motor housing with fresh solvent. The interior **must** be dry and free of dirt or lint.



**Most cleaning solvents are toxic and flammable. Use them only in a well ventilated area; free from excessive heat, sparks, and flame. Read and follow all precautions printed on solvent containers.**

After the motor housing is thoroughly cleaned, position it on a flat surface with the discharge end down. Do not unwrap the stator (33) until the motor housing has been prepared for stator installation. The stator **must** be kept clean and dry. When handling the stator, do not set it on the end windings; lay it on its side and block it from rolling.

Test the new stator as indicated in **Electrical Testing** in **TROUBLESHOOTING**, Section D, to ensure that no damage has occurred during transit or handling.

### NOTE

Remove any drops of varnish from the ends of the stator before installation to ensure proper stack-up height when assembled.

Position an expandable tool, such as a split disc, approximately 2 inches (51 mm) down inside the stator (opposite the lead wire end), and expand it tightly and squarely on the I.D. Attach a lifting device to the lifting eye of the tool, and carefully lift the assembly. Take care not to damage the stator end turns. Slip a sleeve over the stator leads, or tape them together to protect them during installation.

### NOTE

Stator installation involves heating the motor housing. This process must be done quickly to allow the stator to slide into the motor housing before the housing cools.

Heat the motor housing (11) with a torch to expand it enough for the stator (33) to be installed; when heating the motor housing, **make sure** that the stator is clear to avoid a fire hazard, or damage to the windings. Apply heat evenly to the outside of the housing; excessive heat is not required.

When the motor housing is sufficiently heated, position the stator so that the leads are in line with the terminal opening. Carefully lower the stator into the motor housing until fully seated against the housing shoulder. Be careful not to damage the stator lead insulation during reassembly. If the stator "cocks" in the motor housing, remove it and try again.

After the stator is fully and squarely seated on the upper motor housing shoulder, remove the expandable disc tool. Secure the stator in place by torquing the setscrew(13) to 13.5 ft. lbs. (162 in. lbs. or 1,87 m. kg.).

Coat the threads of the pipe plug (12) with `Loctite Pipe Sealant With Teflon No. 592' or equivalent sealant, and install the plug over the allen head set-screw. Untape or remove the protective sleeve from the stator leads.

Cover the motor housing with a clean, lint-free cloth while the rotor is being assembled.

## Bearing Installation

(Figure 1)

Inspect the rotor shaft (34) for damaged threads, scoring in the seal area, and a nicked or damaged keyway. If the bearings were removed, inspect the bearing areas for scoring or galling. Remove nicks and burrs with a fine file or emery cloth. Inspect the rotor area for separated laminations. If the shaft is bent or damaged, or if the laminations are separated, replace the shaft and rotor (a single assembly).



To prevent damage during removal from the shaft, it is recommended that bearings be cleaned and inspected **in place**. It is **strongly** recommended that the bearings be replaced **any** time the shaft and rotor assembly is removed.

The bearings may be heated to ease installation. An induction heater, hot oil bath, electric oven, or hot plate may be used to heat the bearings. Bearings should **never** be heated with a direct flame or directly on a hot plate.

### NOTE

*If a hot oil bath is used to heat the bearings, both the oil and the container must be **absolutely** clean. If the oil has been previously used, it must be **thoroughly** filtered.*

Heat the bearings (9 and 32) to a uniform temperature **no higher than** 250°F (120°C). Slide the upper bearing onto the shaft until it is fully seated against the shaft shoulder, repeat the same procedure for the lower bearing. This should be done quickly, in one continuous motion, to prevent the bearing from cooling and sticking on the shaft.



**Use caution when handling hot bearings to prevent burns.**

After the bearings have been installed and allowed to cool, check to ensure that they have not moved out of position in shrinking. If movement has occurred, use a suitably sized sleeve and a press to reposition the bearings. Make certain that they are seated squarely against the shaft shoulders.

If heating the bearings is not practical, use a suitably sized sleeve and an arbor (or hydraulic) press to install the bearings on the shaft.



When installing the bearings onto the shaft, **never** press or hit against the outer race, balls, or ball cage. Press **only** on the inner race.

### Rotor And Intermediate Installation

(Figure 1)

Use **fresh** solvent to clean all gasket and O-ring surfaces of the motor housing (11) and intermediate (8), completely removing any old gasket and cement material. Inspect the sealing surfaces for burrs, nicks and pits which could cause a poor seal. Repair or replace as require.



**Most cleaning solvents are toxic and flammable. Use them only in a well ventilated area free from excessive heat, sparks, and flame. Read and follow all precautions printed on solvent containers.**

Install the spring washer (15) in the motor housing bore.

Carefully ease the rotor and assembled bearings (9 and 32) into the motor housing (11) so that the upper bearing (32) seats squarely in the motor housing bearing bore.

Install the intermediate O-ring (37) and motor housing gasket (10). Lubricate the I.D. of the intermediate bearing bore.

Position the bearing bore of the intermediate (8) over the lower ball bearing (9) and lower the inter-

mediate over the bearing until it seats squarely on the shoulder of the motor housing. Use caution not to cut the O-ring (37). Coat the threads of the studs (38) with 'NeverSeez' or equivalent compound, and install the hardware (39 and 40). Torque the nuts to 20 ft. lbs. (240 in. lbs. or 2,77 m. kg.).

Refer to **PUMP END REASSEMBLY**, and reassemble the pump end components.

### Terminal Housing And Power Cable Reassembly And Installation

(Figure 2)



The electrical power used to operate this pump is high enough to cause injury or death. Make certain that the control handle on the control box is in the OFF position and locked out, or that the power supply to the control box has been otherwise cut off and locked out, before attempting to open or service the pump assembly. Tag electrical circuits to prevent accidental startup. Obtain the services of a qualified electrician, and refer to the wiring diagram(s) in Installation And Operation Manual, Section B, and the Control Box manual to make electrical connections.

Clean the exterior of the power cable with warm water and mild detergent. Check for obvious physical damage. Check the cable for continuity and insulation resistance (see **Electrical Testing** in TROUBLESHOOTING). Do not attempt repairs except to cut off either end of the cable; **splicing is not recommended**. Reinstall any wire tags or terminals which may have been removed.



**Never attempt to alter the length or repair any power cable with a splice. The pump motor and cable must be completely waterproof. Injury or death may result from alterations.**

Use oil to lightly lubricate the outside of the pump power cable (14), and the bore of the terminal housing (10) and cable grip (15) for ease of assembly. Slide the cable grip and terminal housing on the cable, allowing approximately 3 ft. (1m) of cable to extend beyond the terminal housing. Temporarily tape the green and yellow ground wires to the cable.

### Sealing Terminal Housing Connections With Silicone Adhesive

(Figure 2)



**Do not attempt to operate this pump unless the power cable leads are properly sealed in the terminal housing. Moisture entering the terminal housing could cause a short circuit, resulting in pump damage and possible serious injury or death to personnel.**

When shipped from the factory, the cable leads and terminals (1) were encapsulated in heat-shrink tubing (17), and bonded to the terminal plate (4) with silicone adhesive to provide a water-tight seal. If this insulating material has been damaged or removed during maintenance, **it must** be replaced using materials and equipment approved by Gorman-Rupp (see the parts list for repair kits).

### NOTE

*Heat-shrink tubing **must** be used to seal the power and control cable leads to the terminals before bonding the leads to the terminal plate. If silicone adhesive is not available in the field, a commercially available potting kit may be used to bond the connections to the terminal plate. If this alternate sealing method is used, refer to the instructions in **Sealing Terminal Plate Connections With Potting Compound**. Use **only** materials and heating equipment approved by Gorman-Rupp for field repairs.*

Before resealing the power and control cables, remove all the old adhesive material (or potting compound) from the leads, terminal collars, and terminal plate. Inspect all parts for damage, and replace as required. If the rubber bonding material on the terminal plate (4) is severely worn or cracked, the

terminal plate must be replaced. If the bonding material has been noticeably compressed, it should be supplemented with two gaskets contained in the overhaul gasket kit (see Options listed in the Parts List manual).

#### NOTE

*Clean the cable leads and terminal plate in the areas to be sealed with cleaning solvent. Incomplete sealing will occur if the surfaces are dirt, oil or grease coated.*

Assemble the terminal posts (1), dyna seal washers (20), and terminal nuts (19) to the terminal plate as shown in Figure 2. Install the upper terminal plate gasket (5).

#### NOTE

*Both the power cable and motor conductor leads should be tinned prior to reassembly.*

Slide a length of heat-shrink tubing (17) up over each of the power cable leads. Install the leads on the terminals and secure them using the hex nuts (19). Slide the tubing down each lead until the terminals are covered and the tubing contacts the terminal plate. The tubing **must** extend up the leads far enough to ensure a good seal.

Carefully heat each tube with a commercially available hot air gun capable of producing 750°F (399°C), and shrink the tubes around the cable leads and terminals.



Use **only** Dow-Corning 737 Silicone Adhe-

sive (see the Parts List Manual for the part number) or potting compound for sealing terminal housing connections. Use of unapproved sealing products will void the pump warranty.

#### NOTE

**Do not** use a mold or reservoir with the silicone adhesive.

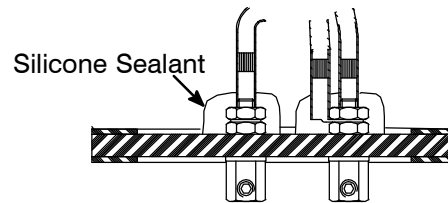

**Figure 4. Silicone Adhesive Sealing**

See Figure 5 and check terminal locations. Apply a 1/4 in. (6,4 mm) thick layer (maximum) of silicone adhesive around each of the terminal posts as shown in Figure 4. Remove any adhesive from gasketed surfaces.



**All air pockets, voids or gaps in the silicone sealant must be removed to ensure a water-tight seal in the terminal housing. Otherwise, moisture entering the terminal housing could cause a short circuit, resulting in pump damage and possible serious injury or death to personnel.**

Allow the adhesive to cure for at least one hour before securing the terminal housing to the motor housing.

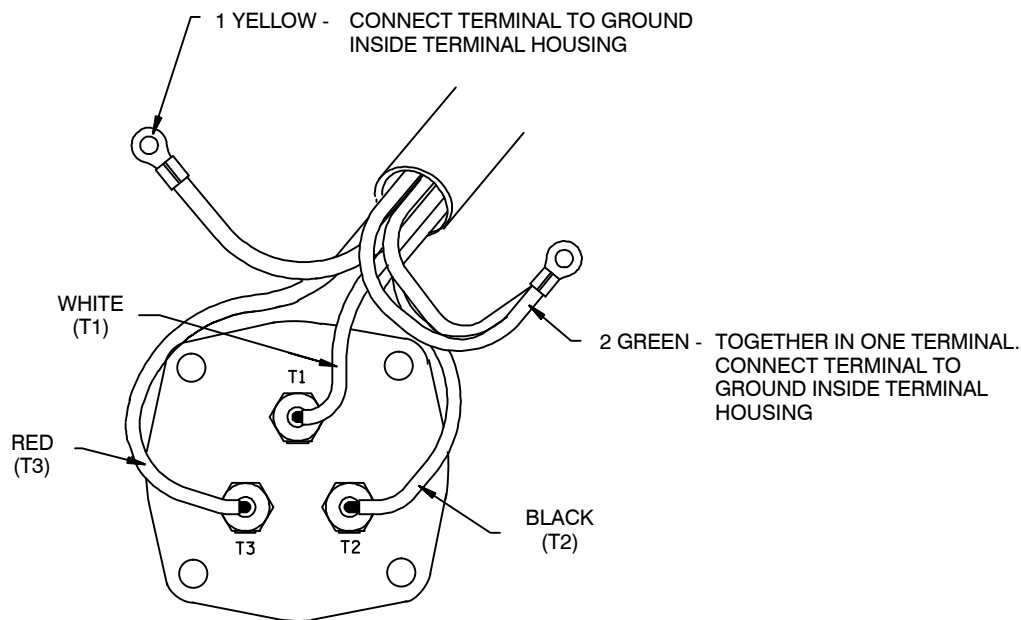

**Figure 4. Terminal Housing Wiring Connections**

### Sealing Terminal Plate Connections With Potting Compound

#### (Figure 2)

Potting compound and silicone adhesive have the same electrical properties when correctly applied. Silicone adhesive is used at the factory to facilitate production. A commercially available potting kit (Products Research Corp., part number PR-1201-Q Class 1 potting compound, Chemseal potting compound, part number GS3100, or equivalent) may also be used to seal the connections.

Clean and assemble all terminal components as indicated in **Sealing Terminal Plate With Silicone Adhesive**. Use medium grit sandpaper to prepare the surface of the terminal plate in the area where the potting mold will be installed.

#### NOTE

*Clean the cable lead and terminal plate in the areas to be potted with cleaning solvent before potting. Potting compound will not adhere properly to oil or grease coated surfaces.*

Trim the potting mold so it is just long enough to cover the terminal. Slide the potting mold up over the leads of the power cable and control cable.

Secure each cable lead as described in the previous section. Slide the potting mold down over the

terminals and onto the terminal plate. Hang the cable in a vertical position with the terminal plate horizontal. The cable leads and terminals should be centered in the potting mold. Use quick-setting cement, such as '3-M Weather Seal' to secure the potting mold to the terminal plate.



**Most potting base compounds contain toluene; use adequate ventilation and avoid prolonged breathing of vapors. Most potting accelerators contain lead; avoid ingestion or prolonged contact with the skin. Read and follow all warnings and recommendations accompanying the potting kit.**

See the instructions with the potting kit regarding application life and setting and curing time. Mix the base compound and accelerator and fill the mold until the electrical connections are completely insulated. Tamp the potting material to eliminate air bubbles and ensure the material has completely covered the area around the terminal posts.

#### NOTE

*The potting compound must completely cover the terminal collar and lead connections.*

When potting has been completed, leave the terminal plate assembly undisturbed until the potting material has cured. Complete curing usually takes about 24 hours. Curing time can be shortened by using a heat lamp, but be careful not to melt the potting or potting mold, or burn the cable. When the potting material is no longer “tacky” to the touch, it has cured.

### Terminal Housing Installation

#### (Figure 2)

After the terminal plate has been sealed, slide the terminal housing down the cable. Untape the ground leads and secure them to the ground terminals with the hardware (6 and 7). **Be sure** the leads make good contact with the housing.

Pull gently on the cable to remove any excess length from within the terminal housing. The terminal plate should fit loosely against the terminal housing.

Lubricate the upper bore of the terminal housing, and slide the cable grip assembly (15) into place. Do not fully tighten the nuts at this time.

Position the lower gasket (3) against the terminal plate.

#### NOTE

*A **small** amount of gasket adhesive may be used to hold the upper and lower terminal plate gaskets in place to ease assembly.*

Position the terminal housing assembly over the motor housing and, using the voltage and phase instructions below, secure the motor leads to the terminal posts (1) using the allen head setscrews (2). (The motor leads may be trimmed to length as required.)

Connect the motor leads (T1, T2, and T3) to corresponding terminal posts (T1, T2 and T3).

After the wire terminals have been secured, check their locations for correctness.

Position the terminal housing and terminal plate against the motor housing. If required, rotate the terminal housing and twist the motor leads to remove excess slack.

#### (Figure 1)

Coat the threads of the motor housing studs (20) with ‘NeverSeez’ or equivalent compound, and secure the terminal housing assembly to the motor housing with the hardware (21 and 22); torque the nuts evenly in a cross sequence to 11 ft. lbs. (132 in. lbs. or 1,5 m. kg.). Tighten the nut (13, Figure 2) drawing the cable grip assembly down into the terminal bore. **Do not** overtighten and damage the terminal gland or hardware.

#### NOTE

*A .12 in. (3,05 mm) gap is required between the terminal gland cap flange and the terminal housing when tighten the nuts.*

See **FINAL ASSEMBLY** and **VACUUM/PRESSURE TESTING** followed by **LUBRICATION**.

### FINAL ASSEMBLY

#### (Figure 1)

If the discharge elbow (28) was removed from the motor housing, replace the discharge flange gasket (17). Apply ‘NeverSeez’ or equivalent compound on the flange studs (18), and secure the flange with the nuts (19).

If the hoisting bail (23) was removed, install the bushings (24) in the motor housing and securing the bail (23) to the motor housing with the hardware (25, 26 and 27).

After performing the vacuum/pressure testing, connect the discharge hose, and reposition the pump. If rigid piping or long hose is used, reposition the pump, then connect the piping.

### VACUUM/PRESSURE TESTING

To ensure the water-tight integrity of the pump, it is recommended that the motor and seal cavities be vacuum and pressure tested any time the seal and/or motor are serviced. The seal cavity **must** be pressurized to prevent separation of the seal faces or unseating the stationary seal seat between the seal and motor cavities. Use a manometer with a range of 30 to 0 to 30 inches of mercury to perform the vacuum test. **Do not** use a vacuum gauge. Vacuum gauges are not sensitive enough to detect minor leaks.

Drain **all** of the oil from **both** the seal and motor cavities before performing the test. Oil within the motor cavity will be drawn into the system, resulting in damage to the vacuum pump or manometer.

It is recommended that a vacuum pump be used to draw the vacuum on the motor cavity. If a vacuum pump is not available, a compressor/venturi system may be used. If the compressor/venturi cannot draw the vacuum level shown in Table E-1, draw the motor cavity vacuum down as far as the system will allow, then pressurize the seal cavity so the differential between the two cavities is the same as

the differential between the readings shown in the table.

If a compressor/venturi system is used, install full-closing ball-type shutoff valves with quick-disconnect fittings in the pipe plug holes in both the motor and seal cavities. This will allow the pressure (or vacuum) to be maintained while using the compressor to perform the second portion of the test.

Figure 5 shows a simple schematic for setting up either a vacuum pump or a venturi/compressor test system.

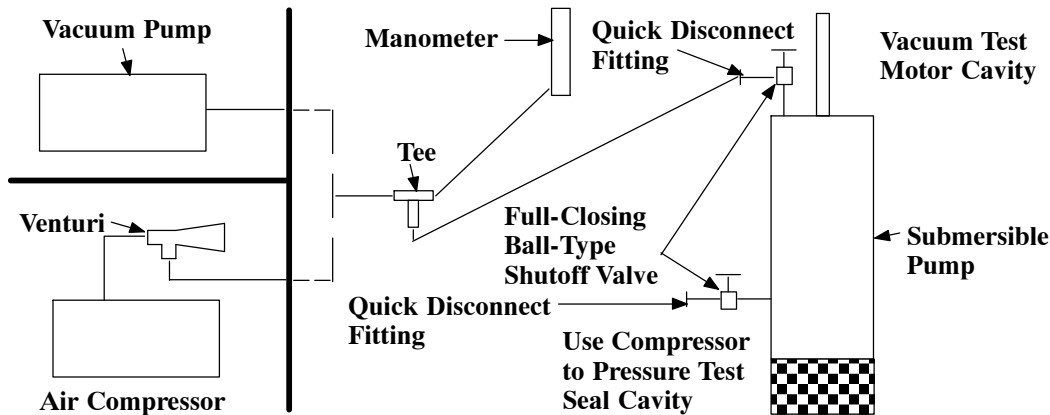

**Figure 5. Vacuum/Pressure Test System**

Table E-1 shows the motor cavity vacuum and seal cavity pressure readings for the test, and the duration to maintain each reading. **Any** change in

the readings during the test indicates a leak which **must** be identified and corrected before putting the pump back into service.

**Table E-1. Vacuum/Pressure Test Data**

Pump Model	Motor Cavity Vacuum (In. Hg.)	Duration (Minutes)	Seal Cavity Pressure (PSI)	Duration (Minutes)
S3A	30	2	15	1

**LUBRICATION**

**Seal Cavity**

Check the oil level in the seal cavity before initial startup, after the first two weeks of operation, and every month thereafter.



**Check the oil level only when the pump is cool. If the oil level plug is removed when the pump is hot, pressure in the**

**seal cavity can cause hot oil to be ejected as the plug is removed.**

To check the seal cavity oil, lay the pump on its side and remove the seal cavity plug (6) in the intermediate. Screw a short 1/4-inch NPT nipple into the hole. Tip the pump and drain off a small amount of oil into a transparent cup. If the oil level is abnormally low, or the color milky or dark, refer to **Draining Oil From Seal Cavity** in this section for instructions and troubleshooting tips. If the oil is clear, apply 'Loctite Pipe Sealant With Teflon No. 592.' or equivalent to the threads of the pipe plug, before reinstalling the plug.

To fill the seal cavity, remove the pipe plug (6) and add the recommended grade of submersible pump oil. Apply `LoctitePipe Sealant With Teflon No. 592.' or equivalent to the threads of the pipe plug, before reinstalling the plug.

cating a dry (overhauled) pump. See Table 3 for lubricant specifications.

The grade of lubricant used is critical to the operation of this pump. Use premium quality hydraulic oil as specified in the following table. Oil must be stored in a clean, tightly closed container in a reasonably dry environment.

See Table E-2 for quantity of lubricant when lubri-

**Table E-2. Oil Quantity**

Pump Model	Seal Cavity	Motor Cavity
S3A	24 ounces (0,7 liters)	56 ounces (1,6 liters)

**Table E-3. Pump Oil Specifications**

Specifications:	
Type .....	Premium high viscosity index, anti-wear hydraulic oil
Viscosity (SSU @ 104°F [40°C]) .....	110 to 155
Viscosity (SSU @ 210°F [100°C]) .....	40 to 50
Dielectric .....	26,000 (volts-min)
Recommended supplier:	
Gulf Oil Company .....	Gulf Harmony AW Hydraulic Fluid MG 32
Acceptable alternate suppliers:	
Gulf Oil Company .....	Gulf Harmony 32 AW
Texas Oil Company .....	Rando HD 32 or HD AZ 32
Sun Oil Company .....	Sunvis 816 or 916
BP (Also Boron) .....	Energol-HLP 32
Shell Oil Company .....	Tellus 32, Tellus T-23 or T32
ARCO .....	Duro 32
Exxon (Also Esso) .....	Nuto H 32
Petro-Canada .....	Harmony HVI 22

**Motor Housing Cavity**

With the pump in an upright position, remove the pressure relief valve (29) on the top of the pump. See Table 2 and add the recommended grade of lubricant (Table E-3) to the motor cavity. **Maintain the oil at this level.** Apply `LoctitePipe Sealant With Teflon No. 592' or equivalent sealant to the threads of the relief valve (29). Reinstall and tighten the valve.



Never attempt to fill the motor cavity through the drain plug (7) opening. A volume of air must be trapped above the motor to permit thermal expansion of the motor oil.

**For Warranty Information, Please Visit  
[www.grpumps.com/warranty](http://www.grpumps.com/warranty)  
or call:  
U.S.: 419-755-1280  
Canada: 519-631-2870  
International: +1-419-755-1352**

**GORMAN-RUPP PUMPS**