

**INSTALLATION AND
OPERATION MANUAL
WITH PARTS LIST**



CONTROL BOX

MODELS:

48319-115

SIMPLEX 460V, 3P, 6HP

TABLE OF CONTENTS

INTRODUCTION	PAGE I - 1
WARRANTY INFORMATION.....	PAGE I - 1
SAFETY - SECTION A	PAGE A - 1
INSTALLATION - SECTION B.....	PAGE B - 1
GENERAL INFORMATION.....	PAGE B - 1
PREINSTALLATION INSPECTION.....	PAGE B - 1
CONTROL BOX INSTALLATION	PAGE B - 1
Enclosure	PAGE B - 1
ELECTRICAL CONNECTIONS	PAGE B - 2
Grounding Methods	PAGE B - 2
Field Wiring Connections (Incoming Power)	PAGE B - 3
Pump Motor Voltage Limits	PAGE B - 3
Power Cable Connections.....	PAGE B - 3
Control Box Specifications.....	PAGE B - 3
OPERATION - SECTION C	PAGE C - 1
CONTROL BOX FUNCTION.....	PAGE C - 1
Component Function	PAGE C - 1
TROUBLESHOOTING - SECTION D	PAGE D - 1
TROUBLESHOOTING CHART	PAGE D - 1
ELECTRICAL TESTING.....	PAGE D - 2
Test Equipment	PAGE D - 2
Voltage Imbalance	PAGE D - 2
SECTIONS E-J RESERVED FOR FUTURE USE	
ELECTRICAL DRAWINGS AND DATA - SECTION K	PAGE K - 1
WIRING DIAGRAM / SYMBOL LIBRARY	PAGE K - 2
WIRING DIAGRAMS / SCHEMATICS.....	PAGE K - 3
CONTROL BOX LAYOUT	PAGE K - 5
CONTROL BOX DIMENSIONS.....	PAGE K - 6
CONTROL BOX TERMINAL DIAGRAM	PAGE K - 7
BILL OF MATERIALS, CONTROL BOX.....	PAGE K - 8
PARTS LIST, CONTROL BOX	PAGE K - 9

INTENTIONALLY LEFT BLANK

INTRODUCTION

Read this manual carefully to learn how to safely install and operate your control box. Failure to do so could result in personal injury or damage to the control box or the pump.

This manual does not include maintenance instructions. Have a qualified electrician perform all maintenance. **Be sure** to follow all safety precautions as outlined by the National Electric Code and all local codes.

These control boxes are Nema Type 3R rainproof enclosures with padlockable front covers. **The enclosures are not designed to be watertight, and should not be submerged.** They are designed for use with 230, 460, 575 and 380 volts, 3 phase Gorman-Rupp submersible pumps. The integral electric motor of the submersible pump **must** be operated through the control box. The control box is **not** explosion-proof and should not be operated in a hazardous atmosphere.

Because pump installations are seldom identical, this manual cannot possibly provide detailed instructions and precautions for every aspect of each specific application. Therefore, it is the responsibility of the owner/installer of the pump to ensure that applications not addressed in this manual are performed **only** after establishing that neither operator safety nor pump integrity are compromised by the installation. Pumps and related equipment **must** be installed and operated according to all national, local and industry standards.

If there are any questions regarding the control box which are not covered in this manual or in other literature accompanying this unit, please contact your Gorman-Rupp distributor, or The Gorman-Rupp Company:

The Gorman-Rupp Company

P.O. Box 1217

Mansfield, Ohio 44901-1217

Phone: (419) 755-1011

or:

Gorman-Rupp of Canada Limited

70 Burwell Road

St. Thomas, Ontario N5P 3R7

Phone: (519) 631-2870

RECORD CONTROL BOX NUMBER

Please record the control box number, voltage, phase, and pump model in the spaces provided below. Your Gorman-Rupp distributor needs this information when you require parts or service.

Control Box: _____

Voltage: _____

Phase: _____

Pump Model: _____

WARRANTY INFORMATION

The warranty provided with your control box is part of Gorman-Rupp's support program for customers who operate and maintain their equipment as described in this and the other accompanying literature. Please note that should the equipment be abused or modified to change its performance beyond the original factory specifications, the warranty will become void and any claim will be denied.

HAZARD AND INSTRUCTION DEFINITIONS

See Page I-2

HAZARD AND INSTRUCTION DEFINITIONS

The following are used to alert personnel to procedures which require special attention, to those which could damage equipment, and to those which could be dangerous to personnel:



Immediate hazards which WILL result in severe personal injury or death. These instructions describe the procedure required and the injury which will result from failure to follow the procedure.



Hazards or unsafe practices which COULD result in severe personal injury or death. These instructions describe the procedure required and the injury which could result from failure to follow the procedure.



Hazards or unsafe practices which COULD result in minor personal injury or product or property damage. These instructions describe the requirements and the possible damage which could result from failure to follow the procedure.

NOTE

Instructions to aid in installation, operation, and maintenance or which clarify a procedure.

SAFETY - SECTION A

The following information applies throughout this manual to Gorman-Rupp Control Boxes.

Because pump installations are seldom identical, this manual cannot possibly provide detailed instructions and precautions for each specific application. Therefore, it is the owner/installer's responsibility to ensure that applications not addressed in this manual are performed only after establishing that neither operator safety nor pump integrity are compromised by the installation.



Before attempting to install, operate, or wire this control box, familiarize yourself with this manual, and with all other literature shipped with the control box. Unfamiliarity with all aspects of control operation covered in this manual could lead to destruction of equipment, injury, or death to personnel.



Before connecting any cable to the control box, be sure to ground the control box. See Section B for suggested grounding methods.



The control box provides overload protection and power control. Do not connect the pump motor directly to the incoming power lines. If the power circuit breaker or overload relay is tripped during operation, correct the problem before resetting or replacing.



The electrical power used to operate this control box is high enough to cause injury or death. Obtain the services of a qualified electrician to make all electrical connections. Make certain that the enclosure is properly grounded; never use gas pipe as an electrical ground. Be sure that the incoming power matches the voltage and phase of the control before connecting the power source. Do not make electrical connections if the voltage is not within the limits. If the overload unit is tripped during operation, correct the problem before restarting.



The electrical power used to operate this control box is high enough to cause injury or death. Make certain that the control handle on the control box is in the OFF position and locked out, or that the power supply to the control box has been otherwise cut off and locked out, before attempting to open or service the control box. Tag electrical circuits to prevent accidental start-up.



Obtain the services of a qualified electrician to make all electrical connections, and to troubleshoot, test and/or service the electrical components of the control box.



Do not attempt to repair individual components of the control box. Any component which fails should be replaced.

INSTALLATION - SECTION B

GENERAL INFORMATION

Review all **SAFETY** information in Section A.

This section is intended only to summarize recommended installation practices for the control box. If there are any questions concerning your specific application, contact your Gorman-Rupp distributor or the Gorman-Rupp Company.

PREINSTALLATION INSPECTION

The control box was inspected before shipment from the factory. Before installation, inspect the control for damage which may have occurred during shipment. Check as follows:

- a. Inspect the control box for cracks, dents, and other obvious damage.
- b. Check that all control box components are securely attached to their mounting surfaces, and that the electrical connections are tight and free of corrosion.
- c. Compare the amperes, phase, voltage and hertz indicated on the pump motor name plate to the ratings indicated for the control box.
- d. Carefully read all tags, decals, and markings on the control box.

If anything appears to be abnormal, contact your Gorman-Rupp distributor or the factory to determine the repair policy. Do not put the control box into service until appropriate action has been taken.

CONTROL BOX INSTALLATION



The control box furnished with the pump is designed to operate the pump. The control box provides overload protection and power control. Do not connect the pump motor directly to the incoming power lines.

Enclosure

The control box is a NEMA Type 3R rainproof enclosure with a padlockable front cover. **The enclosure is not designed to be watertight, and should not be submerged.**

No mounting hardware is furnished with the control box, contact your Gorman-Rupp sales associate for mounting tabs. Secure the control box vertically on a level surface, above flood level. The control should be mounted on a flat surface. If the mounting surface is not perfectly flat, it may be necessary to use shims (not supplied) with the enclosure. The box should be easily accessible to the operator, and located close enough to the pump to avoid excessive voltage drop due to cable length.



Failure to mount the control box vertically on a level surface may affect operation of the pump controls.

After the box is securely installed, make certain the front cover latches properly before installing any electrical lines.

CONTROL BOX DIMENSIONS

For the approximate physical dimensions of your control box, refer to page K-6.

ELECTRICAL CONNECTIONS

**WARNING!**

Obtain the services of a qualified electrician to make all electrical connections and to service the control box.

**WARNING!**

The electrical power used in this control box is high enough to cause injury or death. Make certain that the control box is properly grounded after installation. Make certain that the power source phase and voltage matches the data on the control box. Complete all electrical connections before connecting the power supply to the control box. Make certain to ground the appropriate lead of the power source before connecting power to the control. Make certain that the control box is properly grounded after installation.

Grounding Methods

Electrically ground the installation before connecting the field wiring to the control box. Install a grounding terminal to the enclosure and connect it to a properly embedded electrode.

The material used for the electrode must be an excellent conductor of electricity, such as copper. If iron or steel is used, it must be galvanized or otherwise metal plated to resist corrosion. **Do not** coat the electrode with any material of poor conductivity, such as paint or plastic.

The electrode must conform to the recommendations of N.E.C. ARTICLE 250. Follow all installation requirements of the N.E.C., and all applicable codes. See Figure B-2 for some suggested grounding methods.

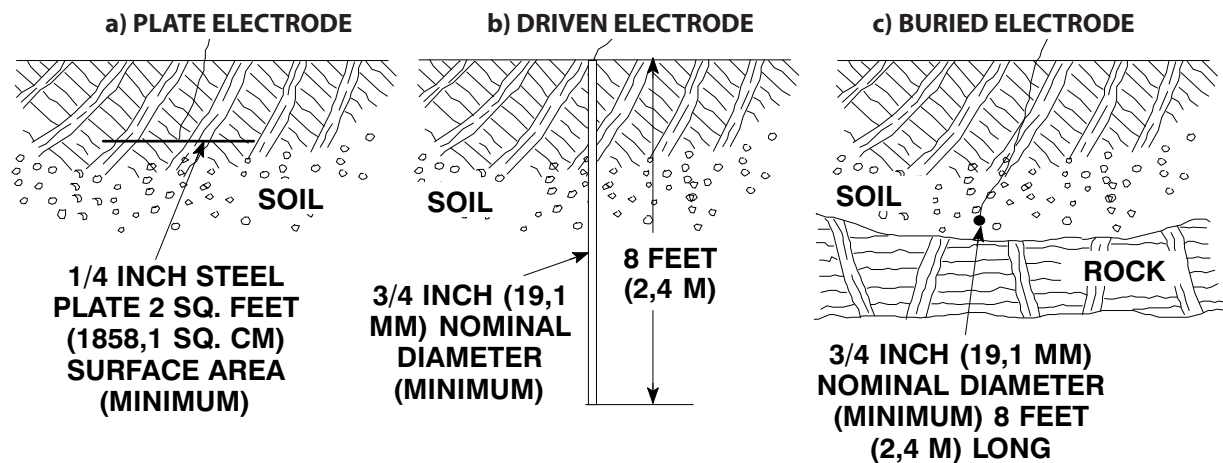

Figure B-2. Suggested Grounding Methods

- Plate Electrode:** An iron or steel plate, 1/4 inch (6,4 mm) thick, completely impeded in the ground. The plate must present a surface area of at least 2 square feet (1858,1 sq. cm).
- Driven Electrode:** A rod or pipe, 3/4 inch (19,1 mm) in diameter minimum, 8 feet (2,4 m) long, completely driven into the ground.
- Buried electrode:** If rock or stone prevents embedding the full 8 foot (2,4 m) length of the ground rod, bury it horizontally in a trench.

Space the ground rod or plates at least 6 feet (1,8 m) from any other electrode or ground rod, such as those used for signal circuits, radio grounds, lightning rods, etc.

The earth surrounding the ground rod or plate **must** contain enough moisture to make a good electrical connection. In dry or sandy areas, pour water around the rod, or consult qualified personnel to devise a method of improving the connection.

Field Wiring Connections (Incoming Power)



The electrical power used to operate this pump is high enough to cause injury or death. Obtain the services of a qualified electrician to make all electrical connections. Make certain that the pump and enclosure are properly grounded; never use gas pipe as an electrical ground. Be sure that the incoming power matches the voltage and phase of the pump and control before connecting the power source. Do not run the pump if the voltage is not within the limits.

The control is designed to regulate the power supply. The field wiring must be properly sized to ensure an adequate voltage supply. The voltage available **at the pump motor** must be within the indicated range.

Table 3. Pump Motor Voltage Limits

Nominal Voltage	Phase	Minimum Voltage	Maximum Voltage
230	3	210	250
380 (50 Hz)	3	345	415
460	3	420	500
575	3	520	630

If the voltage is not within the recommended limits, obtain the services of a qualified electrician to determine the correct field wiring size and other details to ensure an adequate voltage supply.

Make certain all connections are tight and that cable entry points are rainproof. Support the cable weight, if required, to prevent excessive strain on cable clamps and cable.

NOTE

After the power cables have been connected to the control box, make certain the connection is water proof.

Power Cable Connections



The electrical power used to operate the control box is high enough to cause injury or death. Obtain the services of a qualified electrician to make all electrical connections. Make certain that incoming power to the control box is in the off position and locked out, or that the power supply to the control box has been otherwise cut off and locked out, before connecting power or accessory cables.

When necessary to change or connect power cables to the control box, make certain the incoming power is **OFF** and **LOCKED OUT**. Make certain the control box is **properly grounded** and that the electrical data on the control matches the pump motor name plate data.

Connect the power cable to the control box as shown in the wiring diagrams in this section. Use conduit or cable clamps to secure the power and accessory cables to the control box. Make certain that all connections are tight and that cable entry points are rainproof.

Control Box Specifications

Overload relays are provided to protect the pump motor.



If burnout of the overload protection occurs, the complete overload protection must be replaced.

INTENTIONALLY LEFT BLANK

OPERATION - SECTION C

Review all SAFETY information in Section A.

Follow the instructions on all tags, labels and decals attached to the control box.



The electrical power used to operate this control box is high enough to cause injury or death. Make certain that the control handle on the control box is in the OFF position and locked out, or that the power supply to the control box has been otherwise cut off and locked out, before attempting to open or service the control box. Tag electrical circuits to prevent accidental start-up.



Obtain the services of a qualified electrician to make all electrical connections, and to troubleshoot, test and/or service the electrical components of the control box.

CONTROL BOX FUNCTION



The control box is not designed to be explosion-proof. Do not operate in an explosive atmosphere.

The control box is provided to facilitate operation of the pump. It contains controls for starting and stopping the pump, and provides overload protection for the pump motor. The pump control may be equipped with an optional automatic liquid level sensing device, in which case the circuits are also contained within the control box.



The control box provides overload protection and power control. Do not connect the pump motor directly to the incoming power lines. If the power circuit breaker or overload relay is tripped during operation, correct the problem before resetting or replacing.



Since operation of the pump motor is dependent upon the quality and performance of the electrical controls, the pump warranty is valid only when controls have been specified or provided by The Gorman-Rupp Company.

Component Function

The control box contains the following hand operated switches and controls.

- The **tie handle** operates the control box circuit breakers. In the OFF position, the tie handle opens the circuit breakers to interrupt incoming power through the control box and prevent pump operation. In the ON position, it closes the circuit breakers to permit pump operation. The circuit breakers will open or "trip" automatically in the event of a short circuit overload current. When tripped, move the tie handle to OFF and back to ON to reset the circuit breakers.
- The **overload unit** is also the ON and OFF switch. The overload relay will trip automatically if the current drawn by the motor exceeds design specifications. Allow 10 seconds for the unit to cool after tripping before resetting.

NOTE

If the circuit breaker trips, do not reset it immediately. Wait at least ten minutes before resetting the tie handle back to the ON position. If the overload unit continues to trip, operational problems exist.

- The **liquid level devices** (optional equipment) operate in conjunction with the 3-position switch (HAND-OFF-AUTO) supplied for that option. After the level sensors and circuitry have been installed, pump operation may be automatically controlled for filling or dewatering functions.

Always terminate incoming power to the control box before investigating control box circuitry problems.



Always terminate power to the control box before performing service functions.

Power through the control box may be terminated by moving the tie handle to the OFF position, thereby opening the circuit breakers. This stops the pump, but does not terminate incoming power through the field wiring connected to the control box.

TROUBLESHOOTING - SECTION D

Review all **SAFETY** information in Section A.



The electrical power used to operate this control box is high enough to cause injury or death. Obtain the services of a qualified electrician to troubleshoot, test and/or service the electrical components.

Many of the probable remedies listed in the troubleshooting chart below require use of electrical test instruments; for specific procedures, see **Electrical Testing** at the end of the troubleshooting chart.

When troubleshooting, also refer to the technical information accompanying the pump and optional equipment.

TROUBLESHOOTING CHART

TROUBLE	POSSIBLE CAUSE	PROBABLY REMEDY
PUMP FAILS TO START, OVERLOAD UNIT NOT TRIPPED (MANUAL MODE)	Power source incompatible with control box.	Correct power source.
	No voltage at line side of circuit breaker.	Check power source for blown fuse, open overload unit, broken lead, or loose connection.
	No voltage at line terminals on bottom of overload unit in control box.	Check power source for blown fuse, open disconnect, broken wire, or loose connection.
OVERLOAD UNIT TRIPS	Low or high voltage, or excessive voltage drop between pump and control box.	Measure voltage at control box. Check that wiring is correct type, size, and length. (See Field Wiring Connections , Section B).
	Power input phases not balanced.	If imbalance exceeds 1 percent, notify power company.
	Control box not compatible with pump.	Electrical data on control box and pump name plate must agree. Replace control box if not in agreement.
	Foreign object locking impeller or bearing frozen.	Remove foreign material or replace damaged bearing. If bearing is damaged, check for water in motor housing.
	Motor windings short-circuited.	Check motor windings with ohmmeter.

ELECTRICAL TESTING

Be certain to refer to the wiring diagram(s) in Section K of this manual before reconnecting any electrical components which have been disconnected.

Test Equipment

A volt/amp/ohmmeter and megohmmeter of adequate range and quality will be required to conduct the electrical tests. The suggested equipment indicated below is commercially available, or an equivalent substitute may be used.

Equipment	Use
Ammeter/Voltmeter	To check AC Voltage and current (amperage)
Ohmmeter	To measure resistance (ohms) to ground

Voltage Imbalance

Each phase of the incoming three-phase power must be balanced with the other two as accurately as a commercial voltmeter will read. If the phases are out of balance, contact your power company and request that they correct the condition.

ELECTRICAL DRAWINGS AND DATA - SECTION K**WARNING!**

The electrical power used to operate this control box is high enough to cause injury or death. Make certain that the control handle on the control box is in the OFF position and locked out, or that the power supply to the control box has been otherwise cut off and locked out, before attempting to open or service the control box. Tag electrical circuits to prevent accidental start-up.

**WARNING!**

Obtain the services of a qualified electrician to make all electrical connections, and to troubleshoot, test and/or service the electrical components of the control box.

**WARNING!**

Do not attempt to repair individual components of the control box. Any component which fails should be replaced.

48319-115

SYMBOL LIBRARY

WIRING

———— STATION WIRING BY GORMAN RUPP
 - - - - - FIELD WIRING BY OTHERS OR OPTIONAL WIRING

TERMINALS

TB01 -o = GROUND POTENTIAL
 TB02 -o = 120 VAC POTENTIAL

INTENTIONALLY LEFT BLANK

CONDUCTOR COLORS

GROUND	GREEN/YELLOW
200/208/230/240/400,460,480,575/600V	BLACK
120VAC	RED
NEUTRAL	WHITE

WARNING: CONNECT TO CONTROL PANEL GROUND LUG BEFORE APPLYING LINE POTENTIAL. IF APPLICABLE, CONTROL CIRCUIT TO BE GROUNDED BY USER IF CONDITIONS PERMIT

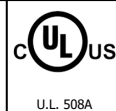

REV.	MODIFICATION	DATE	NAME	APPROVED BY	PAGE DESCRIPTION	SYMBOL LIBRARY
					PROJECT CITY	MANSFIELD
					PROJECT STATE	OHIO - OH
					DATE	DRAWN BY
					04/01/2024	JLS
						APPROVED BY
						AA

PROJECT NAME	CONTROL BOX
--------------	-------------

PROJECT DESCRIPTION	SIMPLEX CONTROL PANEL
DRAWING NUMBER	48319-115
SERIAL NUMBER	
ASSEMBLY DATE	

THE GORMAN-RUPP CO.
 600 S. AIRPORT ROAD
 MANSFIELD, OH 44901



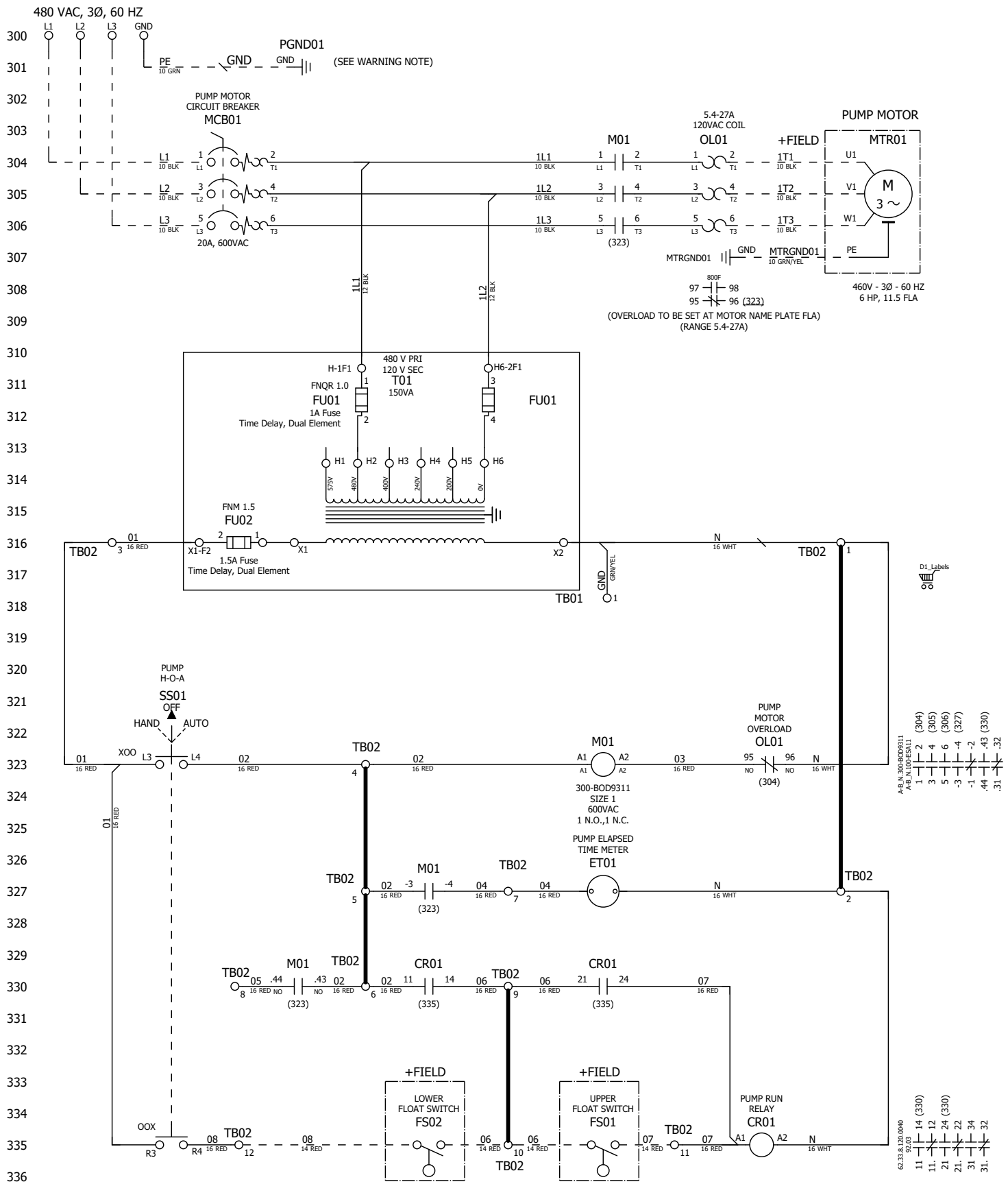

OPTIONS & CONNECTIONS

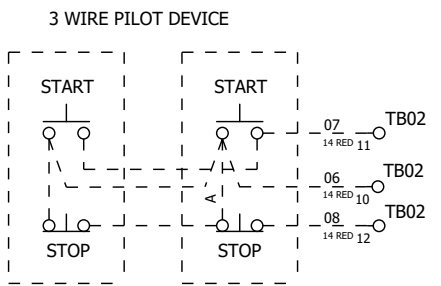

WHEN MORE THAN ONE PUSHBUTTON STATION IS USED, CONNECT PER DASHED LINES OMITTING CONNECTOR "A".

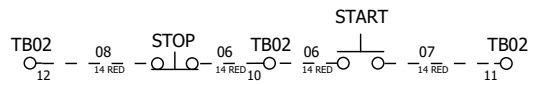

REMOTE PUSHBUTTON IN PLACE OF FLOAT SWITCH

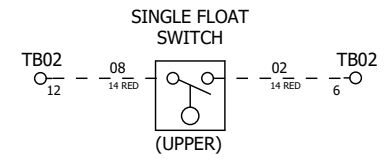
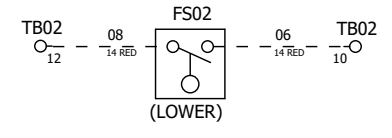
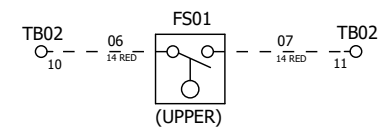

WARNING: CONNECT TO CONTROL PANEL GROUND LUG BEFORE APPLYING LINE POTENTIAL. IF APPLICABLE, CONTROL CIRCUIT TO BE GROUNDED BY USER IF CONDITIONS PERMIT

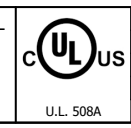

REV.	MODIFICATION	DATE	NAME	APPROVED BY	PAGE DESCRIPTION	PUMP DIAGRAM
					PROJECT CITY	MANSFIELD
					PROJECT STATE	OHIO - OH
					DATE	DRAWN BY
					04/01/2024	JLS
					APPROVED BY	AA

PROJECT NAME	CONTROL BOX
--------------	-------------

PROJECT DESCRIPTION	SIMPLEX CONTROL PANEL
DRAWING NUMBER	48319-115
SERIAL NUMBER	ASSEMBLY DATE

THE GORMAN-RUPP CO.
600 S. AIRPORT ROAD
MANSFIELD, OH 44901



DOOR VIEW



INNER DOOR VIEW

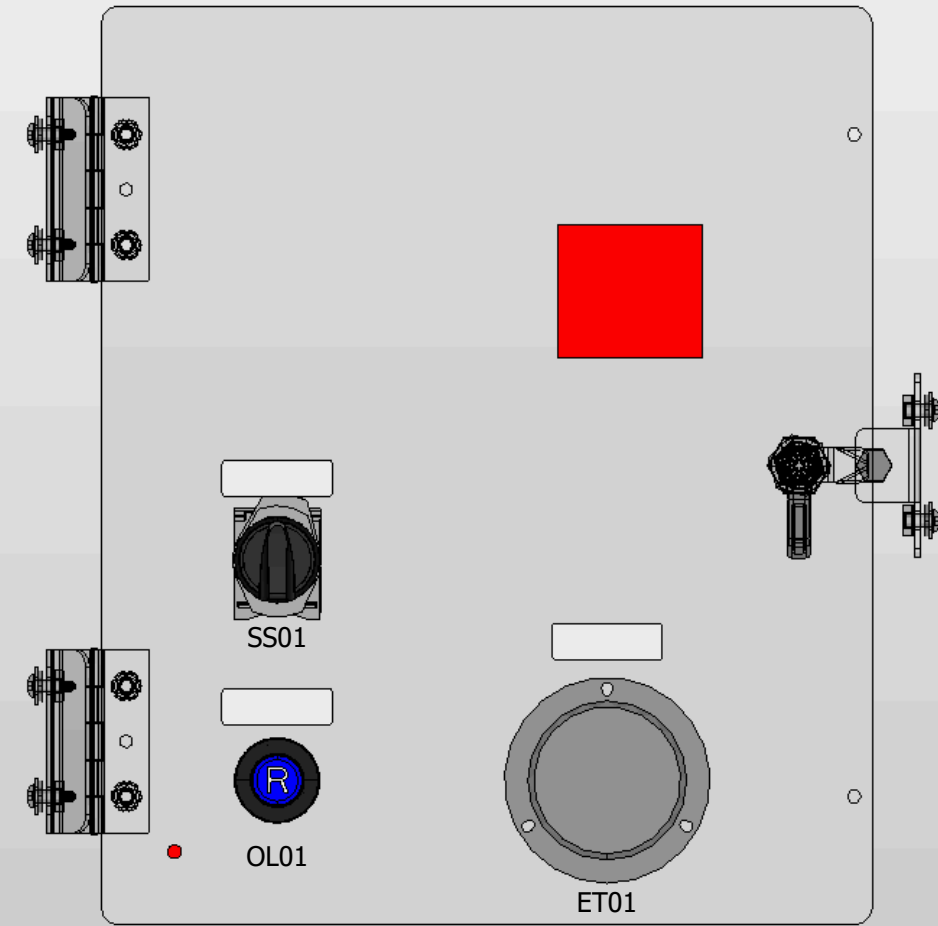

WARNING: CONNECT TO CONTROL PANEL GROUND LUG BEFORE APPLYING LINE POTENTIAL. IF APPLICABLE, CONTROL CIRCUIT TO BE GROUNDED BY USER IF CONDITIONS PERMIT

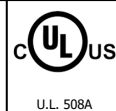

REV.	MODIFICATION	DATE	NAME	APPROVED BY	PAGE DESCRIPTION	OUTER & INNER DOOR VIEW
					PROJECT CITY	MANSFIELD
					PROJECT STATE	OHIO - OH
					DATE	DRAWN BY
		04/01/2024	JLS	AA	APPROVED BY	

PROJECT NAME	CONTROL BOX
--------------	-------------

PROJECT DESCRIPTION	SIMPLEX CONTROL PANEL
DRAWING NUMBER	48319-115
SERIAL NUMBER	ASSEMBLY DATE

THE GORMAN-RUPP CO.
600 S. AIRPORT ROAD
MANSFIELD, OH 44901



MOUNTING PANEL VIEW

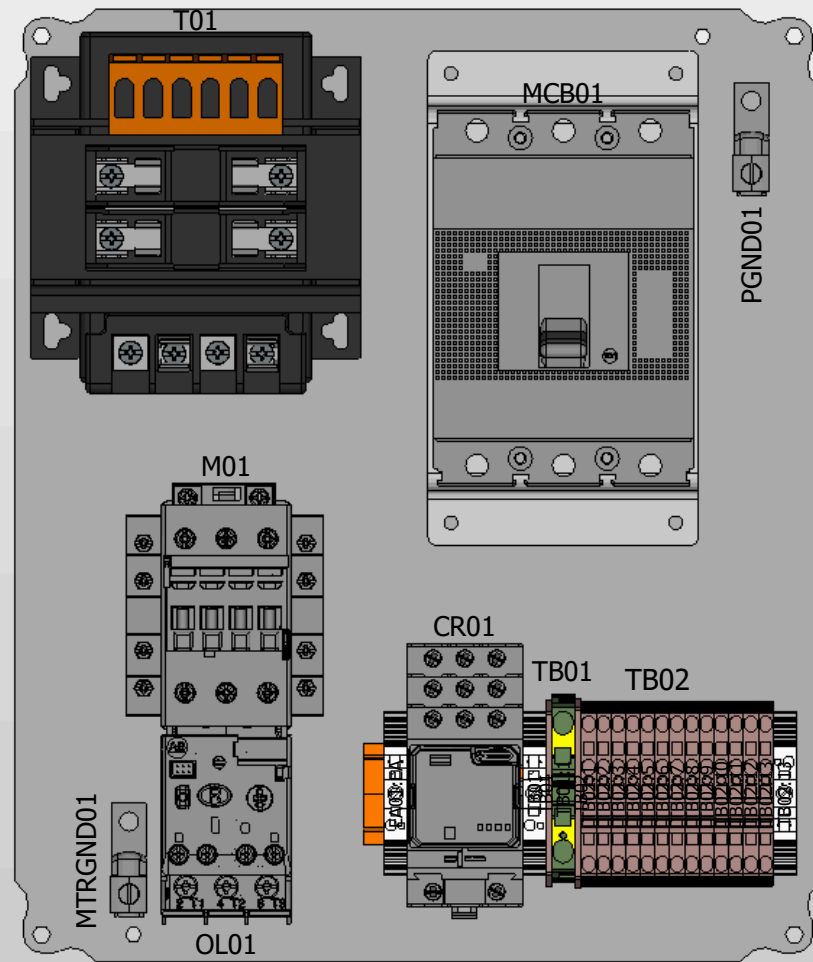

INTENTIONALLY LEFT BLANK

WARNING: CONNECT TO CONTROL PANEL GROUND LUG BEFORE APPLYING LINE POTENTIAL. IF APPLICABLE, CONTROL CIRCUIT TO BE GROUNDED BY USER IF CONDITIONS PERMIT

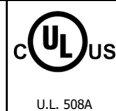

REV.	MODIFICATION	DATE	NAME	APPROVED BY

PAGE DESCRIPTION	MOUNTING PANEL VIEW
PROJECT CITY	MANSFIELD
PROJECT STATE	OHIO - OH
DATE	DRAWN BY
04/01/2024	JLS
	APPROVED BY
	AA

PROJECT NAME
CONTROL BOX

PROJECT DESCRIPTION
SIMPLEX CONTROL PANEL

DRAWING NUMBER	SERIAL NUMBER
48319-115	ASSEMBLY DATE

THE GORMAN-RUPP CO.
600 S. AIRPORT ROAD
MANSFIELD, OH 44901



SIMPLEX PUMP CONTROL

ACROSS-THE-LINE STARTER 3 POLE
THERMAL MAGNETIC TRIP CIRCUIT BREAKER
TYPE 140G, NEMA 3R ENCLOSURE

140G – MOTOR CIRCUIT BREAKERS ARE THERMAL AND MAGNETIC TRIP. SET ADJUSTABLE TRIPS TO TRIP AT APPROXIMATELY 9-11 TIMES FULL LOAD CURRENT (FLA). MOTORS ARE OF SPECIAL DESIGN AND DO NOT REQUIRE HIGHER SETTINGS. A TRIPPED BREAKER STRONGLY INDICATES A FAULT CONDITION IS PRESENT.

TOP HAND VIEW

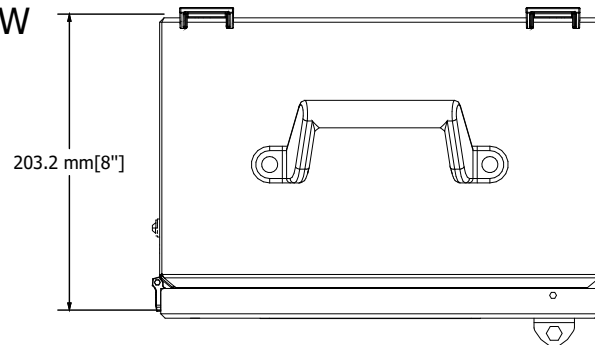

FRONT HAND VIEW

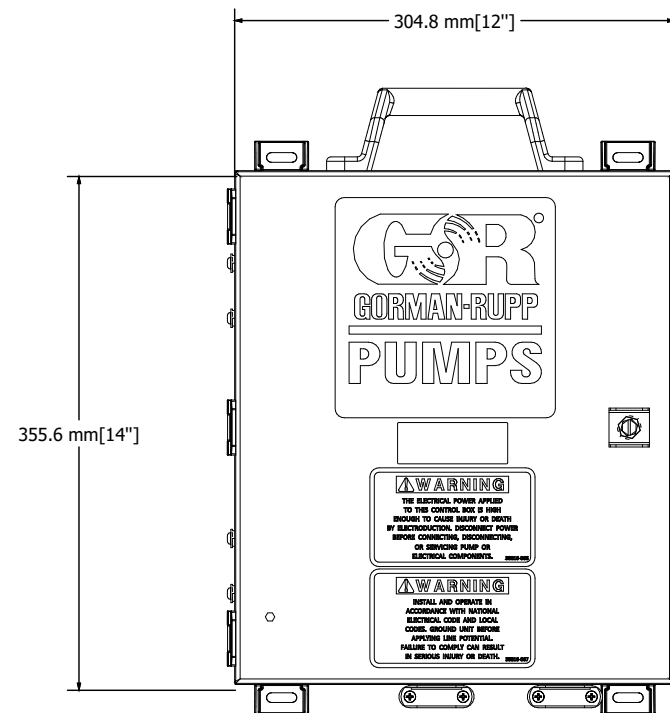

OVERLOAD
PRESS THE RESET BUTTON TO SET RELAY.
ALLOW 10 SECONDS FOR RELAY TO COOL
AFTER TRIPPING BEFORE PRESSING RESET.

WARNING
AFTER BEING PLACED IN SERVICE, THE TRIPPING OF THE CIRCUIT BREAKER IS AN INDICATION THAT A FAULT CURRENT HAS BEEN INTERRUPTED. CURRENT CARRYING COMPONENT PARTS OF THE MAGNETIC MOTOR CONTROLLER SHOULD BE EXAMINED AND REPLACED IF DAMAGED TO PROVIDE CONTINUED PROTECTION AGAINST FIRE OR SHOCK HAZARD.

LEFT HAND SIDE VIEW

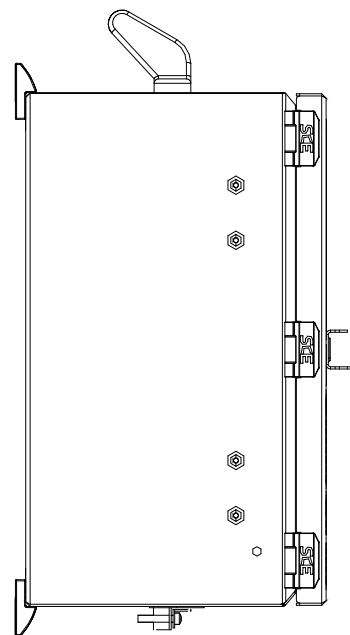

RIGHT HAND SIDE VIEW

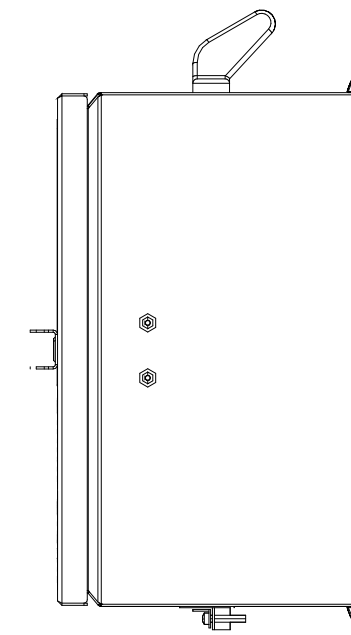

BOTTOM HAND VIEW

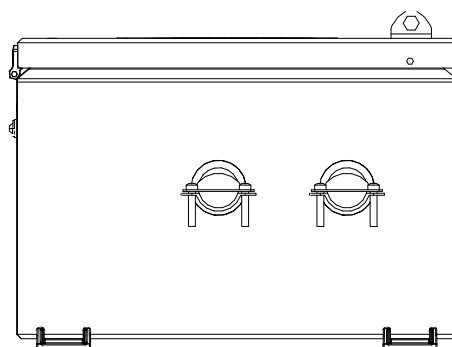

P/N 38814-072 AFFIX TO CONTROL PANEL DOOR

PUMP CONTROL PANEL

THE GORMAN-RUPP COMPANY
MANSFIELD, OHIO ST. THOMAS, ONTARIO

DWG. NO. 48319-115 S/N (ASSEMBLY DATE)

460 VOLTS 3 PH ___ W 60 HZ
MIN. MAIN WIRE 15 AMPS ENCL TYPE 3R
LARGEST MOTOR FLA 11.5 AMPS UL TYPE 1
SHORT CIRCUIT AMPS 5 ka rms sys 460 V MAX OR
___ ka WHEN PROTECTED BY ___ A MAX RK1, RMS OR J FUSE

MANUFACTURING NOTES:

- STATION NUMBER LABEL: B30C-1125-595-RD LABEL
- USE BRADY.B33-37-8591-WT, DEV 49 15342 LABELS FOR DOOR DEVICES
- USE 27788-505 FOR SELECTOR SWITCH JUMPER
- THICKNESS OF MATERIAL ON PERFOREX = SET TO 2.0
- ENSURE GROUND ON INNER DOOR AND OUTER DOOR

P/N 38816-060 AFFIX TO CONTROL BACKPLATE NEAR FUSES

WARNING

TO REDUCE RISK OF FIRE, REPLACE ONLY WITH THE SAME TYPE AND RATING OF USE OR EQUIVALENT.
WARNING
FU1: FNQR 1 FU2: FNM 1.5 FU3: _____
FU4: _____ FU5: _____ FU6: _____

WARNING: CONNECT TO CONTROL PANEL GROUND LUG BEFORE APPLYING LINE POTENTIAL. IF APPLICABLE, CONTROL CIRCUIT TO BE GROUNDED BY USER IF CONDITIONS PERMIT		REV.	MODIFICATION	DATE	NAME	APPROVED BY	PAGE DESCRIPTION	5 SIDED VIEWS	PROJECT NAME	PROJECT DESCRIPTION	THE GORMAN-RUPP CO. 600 S. AIRPORT ROAD MANSFIELD, OH 44901		PAGE 6
							PROJECT CITY	MANSFIELD					
							PROJECT STATE	OHIO - OH					
				04/01/2024	JLS	AA	DATE	DRAWN BY					
	U.L. 508A						CONTROL BOX			DRAWING NUMBER	SERIAL NUMBER		
										48319-115	ASSEMBLY DATE		

TERMINAL DIAGRAM

GR_TerminalStrip

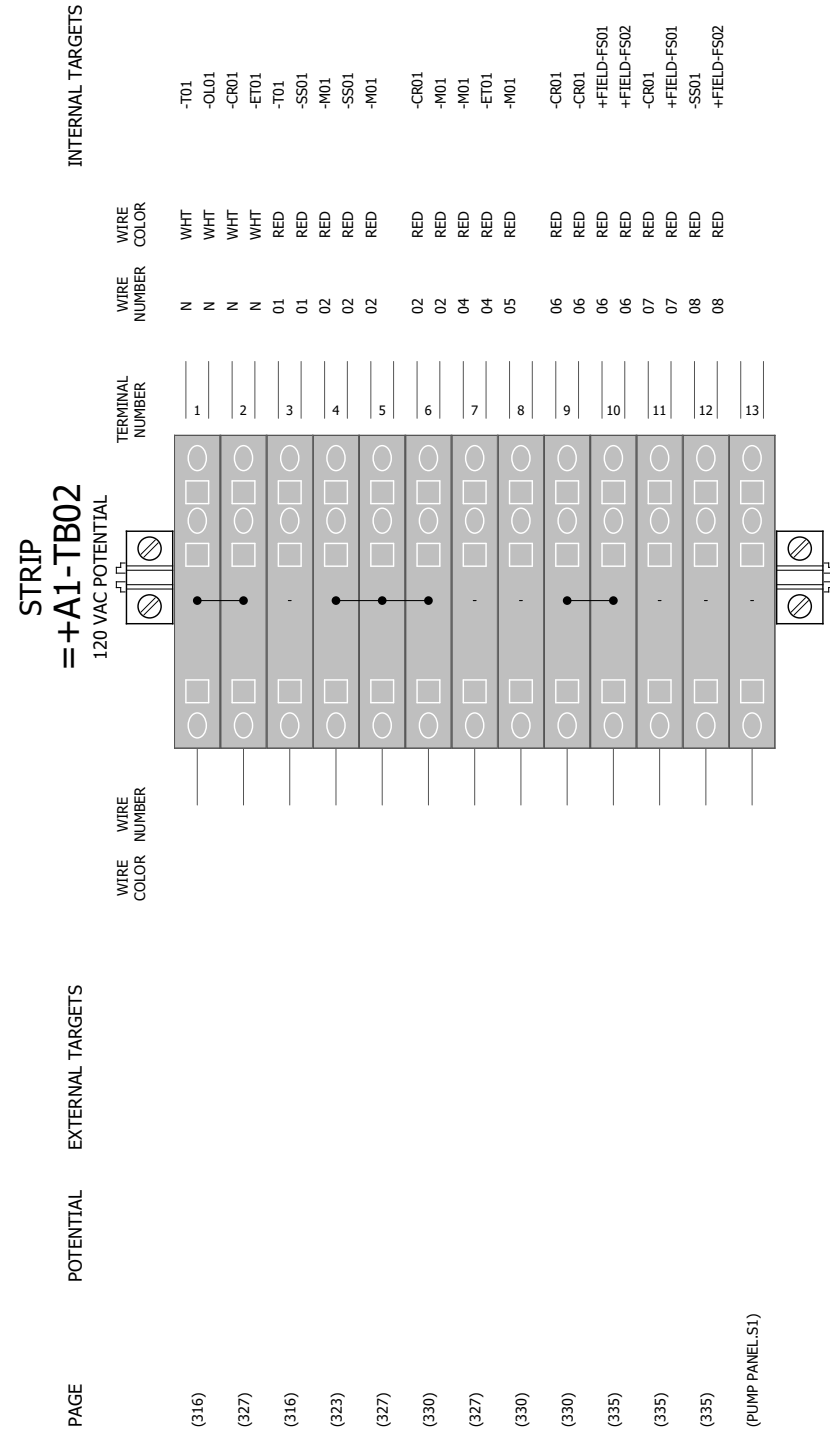
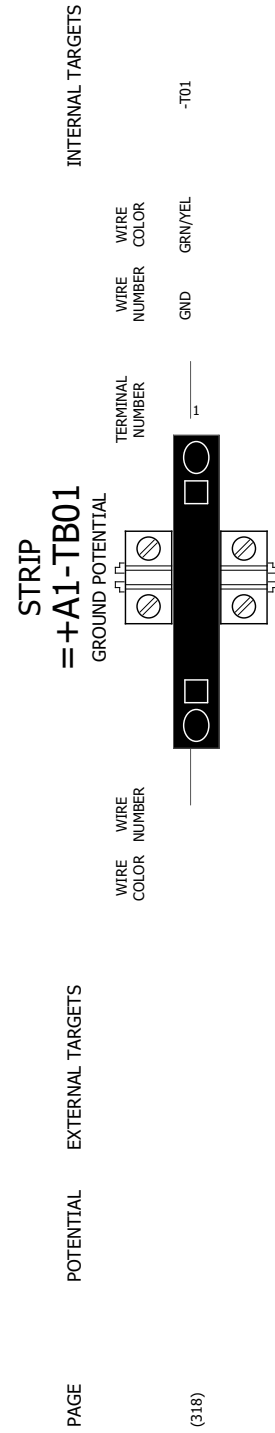

INTENTIONALLY LEFT BLANK

WARNING: CONNECT TO CONTROL PANEL GROUND LUG BEFORE APPLYING LINE POTENTIAL. IF APPLICABLE, CONTROL CIRCUIT TO BE GROUNDED BY USER IF CONDITIONS PERMIT

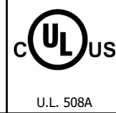

REV.	MODIFICATION	DATE	NAME	APPROVED BY	PAGE DESCRIPTION	TERMINAL DIAGRAM
					PROJECT CITY	MANSFIELD
					PROJECT STATE	OHIO - OH
					DATE	DRAWN BY
		04/01/2024	JLS	AA	APPROVED BY	

PROJECT NAME
CONTROL BOX

PROJECT DESCRIPTION	
SIMPLEX CONTROL PANEL	
DRAWING NUMBER	SERIAL NUMBER
48319-115	ASSEMBLY DATE

THE GORMAN-RUPP CO.
600 S. AIRPORT ROAD
MANSFIELD, OH 44901



GR BILL OF MATERIAL

GR_BOM

GR PART #	QUANTITY	MANUFACTURER	MANUFACTURER'S PART #	DESCRIPTION
2577CV	1	GORMAN RUPP	2577CV	Shipping Box
12354 13010	1	GORMAN RUPP	12354 13010	Enclosure Carry Handle - Machined Part
18614-022	1	A+ CORP	HXC 2X2	Inhibitor, 10 CU FT
26862-123	1	GRASSLIN	FWZ72-120/60	Hour Meter, 7 Digit Display
27161-202	1	SAGINAW	14128ELJ	ELJ Enclosure
27161-982	1	SAGINAW	14P12GALV	Subpanel
27161-983	1	SAGINAW	DFJ1412	Dead Front, ELJ & CH
27161-984	1	SAGINAW	MINQPL	Bracket
27182-161	2	HOFFMAN	AHK38164X	Hardware Kit, Type 4X, UL-Recognized. 3/8-16, Tumbled, Stainless Steel 304
27184-165	2	NEER	C-1001-R	NEER Connector, Uninsulated, Two Screw Type
27222-004	2	PANDUIT	CBA70-14-CY	Copper Cable Lug, 70 Amp, #4-14
27233-040	1	ALLEN-BRADLEY	1492-EBL3T	End Barrier
27233-041	1	ALLEN-BRADLEY	1492-EBL6	End Barrier
27233-054	3	ALLEN-BRADLEY	1492-EAJ35	End Anchor
27233-117	1	WEIDMULLER	166962000	Terminal Block Operating Tool
27233-367	13	ALLEN-BRADLEY	1492-L3T	Feed-through terminal
27233-371	1	ALLEN-BRADLEY	1492-LG6	PE terminal
27275-017	1	FINDER	92.03	Screw terminal socket panel, for 62.32/66.33
27279-147	1	FINDER	092.71	Metal retaining clip, S92
27311-042	1	COOPER BUSSMAN	FNM 1.5	1.5A Fuse, Time Delay, Dual Element
27311-413	2	COOPER BUSSMAN	FNQR 1.0	1A Fuse, Time Delay, Dual Element
27323-202	1	ALLEN-BRADLEY	140G-H2C3-C20	Molded Case Circuit Breakers, Frame H, 20A, TP, 25KA@480V
27324-231	2	ALLEN-BRADLEY	140G-H-TLC13	Terminal Lug, 125A, H-Frame
27381-085	2	ALLEN-BRADLEY	800F-Q10	1 N.O. Contact Block
27382-003	1	ALLEN-BRADLEY	800F-ALP	Latch
27385-493	1	ALLEN-BRADLEY	800FP-SM32	3-Pos Selector Switch
27434-053	1	FINDER	62.33.8.120.0040	Power relay, 3 pole, 16 A - AC (50/60 Hz) - 120 V - AgCdO - Standard
27494-021	1	ALLEN-BRADLEY	199-DR1	DIN Mounting Rail
27513-021	1	ALLEN-BRADLEY	300-BOD9311	NEMA Size 1, Bulletin 300, AC Contactor
27524-008	1	ALLEN-BRADLEY	800FP-R611	Reset
27524-035	1	ALLEN-BRADLEY	800F-ATR19	Threaded Reset Rod, 515 mm length
27527-125	1	ALLEN-BRADLEY	100-ESB11	Auxiliary Contact, 1NO, 1NC, Right Side
27541-358	1	ALLEN-BRADLEY	193-1EFEG	Overload, Size 1, 5.4-27A, NEMA 300
27557-083	1	DONGAN	DT-0150-4179	Transformer, 150VA, Variable Primary Voltage
29812-020	1	BRADY	94913	Arc Flash Hazard Label
34621-538 13000	1	GORMAN RUPP	34621-538 13000	Circuit Breaker Bracket - Machined Part
38811-497	1	GORMAN RUPP	38811-497	Adhesive Sticker, 48319-115's Electrical Drawings
38816-066	1	GORMAN RUPP	38816-066	Warning Decal

GR PART #	QUANTITY	MANUFACTURER	MANUFACTURER'S PART #	DESCRIPTION
38816-067	1	GORMAN RUPP	38816-067	Warning Decal
38817-088	1	GORMAN RUPP	38817-088	Warning High Interrupting Label
38817-092	1	GORMAN RUPP	38817-092	Spring Cage Terminal Block Label
GR-06	1	GORMAN RUPP	GR-06	GR-06 Decal
GR.DEV 29 15342	1	BRADY	B30C-1125-595-RD	1.125" X 3.0" LABEL (SERIAL NUMBER)
GR.DEV 49 15342	3	BRADY	B33-37-8591-WT	0.5" X 1.5" LABEL, ELAPSED TIME METER
NOT_PURCHASED_01	1	ALLEN-BRADLEY	100-ESA11	Auxiliary Contact, 1NO, 1NC, Left Side, Included with MS
OM-07684	1	GORMAN RUPP	OM-07684	CONTROL PANEL MANUAL ES - PANEL 48319-115
SCE.n/a_01	4	SAGINAW	ELJMFK	Foot Kit
SCE.n/a_02	1	SAGINAW	DFJ-Bracket	Bracket for ELJ DeadFronts

WARNING: CONNECT TO CONTROL PANEL GROUND LUG BEFORE APPLYING LINE POTENTIAL. IF APPLICABLE, CONTROL CIRCUIT TO BE GROUNDED BY USER IF CONDITIONS PERMIT

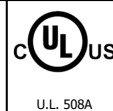

REV.	MODIFICATION	DATE	NAME	APPROVED BY	PAGE DESCRIPTION	BOM	PROJECT NAME	PROJECT DESCRIPTION	THE GORMAN-RUPP CO.	PAGE
					PROJECT CITY	MANSFIELD	CONTROL BOX	SIMPLEX CONTROL PANEL	600 S. AIRPORT ROAD MANSFIELD, OH 44901	8
					PROJECT STATE	OHIO - OH				
					DATE	DRAWN BY				
					04/01/2024	JLS	AA	DRAWING NUMBER	SERIAL NUMBER	ASSEMBLY DATE
								48319-115		



PARTS LIST

DT	GR PART #	QUANTITY	MANUFACTURER	MANUFACTURER'S PART #	DESCRIPTION 1	DESCRIPTION 2	PLACEMENT
CG01	27184-165	1	NEER	C-1001-R	NEER Connector, Uninsulated, Two Screw Type		(PUMP PANEL-S1)
CG02	27184-165	1	NEER	C-1001-R	NEER Connector, Uninsulated, Two Screw Type		(PUMP PANEL-S1)
CR01	27434-053	1	FINDER	62.33.8.120.0040	Power relay, 3 pole, 16 A - AC (50/60 Hz) - 120 V - AgCdO - Standard	Relay	(335)
CR01	27275-017	1	FINDER	92.03	Screw terminal socket panel, for 62.32/66.33	Socket	(335)
CR01	27279-147	1	FINDER	092.71	Metal retaining clip, S92	Accessories	(335)
D1_Labels	29812-020	1	BRADY	94913	Arc Flash Hazard Label	Dimensions: 3.5"H x 5" W, Polyester Material. Black, text. Orange on White Color.	(317)
D1_Labels	38817-092	1	GORMAN RUPP	38817-092	Spring Cage Terminal Block Label		(317)
D1_Labels	27233-117	1	WEIDMULLER	166962000	Terminal Block Operating Tool	ZDK 2.5-2, Z Series	(317)
D1_Labels	38817-088	1	GORMAN RUPP	38817-088	Warning High Interrupting Label		(317)
D1_Labels	OM-07684	1	GORMAN RUPP	OM-07684	CONTROL PANEL MANUAL ES - PANEL 48319-115		(317)
D1_Labels	38811-497	1	GORMAN RUPP	38811-497	Adhesive Sticker, 48319-115's Electrical Drawings	To be placed on front door inner surface, top right corner	(317)
D1_Labels	2577CV	1	GORMAN RUPP	2577CV	Shipping Box		(317)
DR01	27494-021	1	ALLEN-BRADLEY	199-DR1	DIN Mounting Rail	35mm x 7.5 mm x 1 m	(PUMP PANEL-S1)
EA01	27233-054	1	ALLEN-BRADLEY	1492-EA35	End Anchor	Gray	(PUMP PANEL-S1)
EN01	27161-202	1	SAGINAW	14128ELJ	ELJ Enclosure	ANSI-61 gray powder coating inside and out. Optional sub-panels are powder coated white.	(PUMP PANEL-S1)
EN01	27161-982	1	SAGINAW	14P12GALV	Subpanel	Flat Galvannealed	(PUMP PANEL-S1)
EN01	SCE.n/a_02	1	SAGINAW	DFJ-Bracket	Bracket for ELJ DeadFronts		(PUMP PANEL-S1)
EN01	18614-022	1	A+ CORP	HXC 2X2	Inhibitor, 10 CU FT	Humidisorb+, X-Corrode	(PUMP PANEL-S1)
EN01	27161-983	1	SAGINAW	DFJ1412	Dead Front, ELJ & CH	Powder coated white inside and out.	(PUMP PANEL-S1)
EN01	SCE.n/a_01	4	SAGINAW	ELJMFK	Foot Kit	ELJ Mounting (4pc.)	(PUMP PANEL-S1)
EN02	27161-984	1	SAGINAW	MINQPL	Bracket	Mini Quarter Turn Padlock Bracket	(PUMP PANEL-S1)
ET01	26862-123	1	GRASSLIN	FWZ72-120/60	Hour Meter, 7 Digit Display	Intermatic, Black Polycarbonate	(327)
ET01	GR.DEV 49 15342	1	BRADY	B33-37-8591-WT	0.5" X 1.5" LABEL, ELAPSED TIME METER	WEATHER RESISTANT	(327)
FU01	27311-413	2	COOPER BUSSMAN	FNQR 1.0	1A Fuse, Time Delay, Dual Element	FNQ-R-1.0	(312)
FU02	27311-042	1	COOPER BUSSMAN	FNM 1.5	1.5A Fuse, Time Delay, Dual Element	Eaton Cooper Bussman, FNM-1-1/2	(316)
HDL01	12354 13010	1	GORMAN RUPP	12354 13010	Enclosure Carry Handle - Machined Part	Use with Main Plant Panels	(PUMP PANEL-S1)
HDL01	27182-161	2	HOFFMAN	AHK38164X	Hardware Kit, Type 4X, UL-Recognized. 3/8-16, Tumbled, Stainless Steel 304	10 screws, sealing washers and locking nuts	(PUMP PANEL-S1)
LBL01	GR-06	1	GORMAN RUPP	GR-06	GR-06 Decal		(PUMP PANEL-S1)
LBL02	38816-066	1	GORMAN RUPP	38816-066	Warning Decal		(PUMP PANEL-S1)
LBL03	38816-067	1	GORMAN RUPP	38816-067	Warning Decal		(PUMP PANEL-S1)
LBL04	GR.DEV 29 15342	1	BRADY	B30C-1125-595-RD	1.125" X 3.0" LABEL (SERIAL NUMBER)	WEATHER RESISTANT	(PUMP PANEL-S1)
M01	27513-021	1	ALLEN-BRADLEY	300-BOD9311	NEMA Size 1, Bulletin 300, AC Contactor	1 NO 1 NC Auxiliary Contacts	(323)
M01	NOT_PURCHASED_01	1	ALLEN-BRADLEY	100-ESA11	Auxiliary Contact, 1NO, 1NC, Left Side, Included with MS	Size 1...3	(323)
M01	27527-125	1	ALLEN-BRADLEY	100-ESB11	Auxiliary Contact, 1NO, 1NC, Right Side	Side Mounting	(323)
MCB01	27323-202	1	ALLEN-BRADLEY	140G-H2C3-C20	Molded Case Circuit Breakers, Frame H, 20A, TP, 25kA@480V	3-Pole	(304)
MCB01	34621-538 13000	1	GORMAN RUPP	34621-538 13000	Circuit Breaker Bracket - Machined Part	Used for Main Plant Panels	(304)
MCB01	27324-231	2	ALLEN-BRADLEY	140G-H-TLC13	Terminal Lug, 125A, H-Frame	140G Molded Case Circuit Breaker Accessories	(304)
MTRGND01	27222-004	1	PANDUIT	CBA70-14-CY	Copper Cable Lug, 70 Amp, #4-14	Stud Hole 1/4", 1 hole	(307)
OL01	27541-358	1	ALLEN-BRADLEY	193-1EFEG	Overload, Size 1, 5.4-27A, NEMA 300	Direct Mount E100, Energy Saving	(304)
OL01	27524-008	1	ALLEN-BRADLEY	800FP-R611	Reset	Plastic	(304)
OL01	27524-035	1	ALLEN-BRADLEY	800F-ATR19	Threaded Reset Rod, 515 mm length	Standard Length	(304)
OL01	GR.DEV 49 15342	1	BRADY	B30EP-172-593-WT	0.5" X 1.5" LABEL, RESET	WEATHER RESISTANT	(304)
PGND01	27222-004	1	PANDUIT	CBA70-14-CY	Copper Cable Lug, 70 Amp, #4-14	Stud Hole 1/4", 1 hole	(301)
SS01	27385-493	1	ALLEN-BRADLEY	800FP-SM32	3-Pos Selector Switch	Plastic	(320)
SS01	27382-003	1	ALLEN-BRADLEY	800F-ALP	Latch	Plastic	(320)
SS01	27381-085	2	ALLEN-BRADLEY	800F-Q10	1 N.O. Contact Block	1 N.O.	(320)
SS01	GR.DEV 49 15342	1	BRADY	B33-37-8591-WT	0.5" X 1.5" LABEL, HAND-OFF-AUTO	WEATHER RESISTANT	(320)
T01	27557-083	1	DONGAN	DT-0150-4179	Transformer, 150VA, Variable Primary Voltage	575/480/400/240/200 Primary, 120/240 Secondary	(310)
TB01	27233-054	1	ALLEN-BRADLEY	1492-EA35	End Anchor	Gray	()
TB01	27233-041	1	ALLEN-BRADLEY	1492-EBL6	End Barrier	Gray	()
TB01	27233-371	1	ALLEN-BRADLEY	1492-LG6	PE terminal	Feed-Through Ground Block	(318)
TB02	27233-040	1	ALLEN-BRADLEY	1492-EBL3T	End Barrier	Gray	()
TB02	27233-367	13	ALLEN-BRADLEY	1492-L3T	Feed-through terminal	Feed-through Terminal Block with 2 points on one side	(316);(323);(327);(330)
TB02	27233-054	1	ALLEN-BRADLEY	1492-EA35	End Anchor	Gray	

WARNING: CONNECT TO CONTROL PANEL GROUND LUG BEFORE APPLYING LINE POTENTIAL. IF APPLICABLE, CONTROL CIRCUIT TO BE GROUNDED BY USER IF CONDITIONS PERMIT

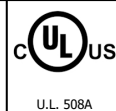

REV.	MODIFICATION	DATE	NAME	APPROVED BY	PAGE DESCRIPTION	PARTS LIST
					PROJECT CITY	MANSFIELD
					PROJECT STATE	OHIO - OH
					DATE	DRAWN BY
					04/01/2024	JLS
					APPROVED BY	AA

PROJECT NAME	CONTROL BOX
--------------	-------------

PROJECT DESCRIPTION	SIMPLEX CONTROL PANEL
DRAWING NUMBER	48319-115
SERIAL NUMBER	
ASSEMBLY DATE	

THE GORMAN-RUPP CO.
600 S. AIRPORT ROAD
MANSFIELD, OH 44901

