

INSTALLATION, OPERATION, PARTS LIST,
AND MAINTENANCE MANUAL

A C E



OM-01323-0E01

February 26, 1981

A large, black outline drawing of the pump assembly, showing the main body, a vertical shaft with a pulley, and various mounting and connection points.

***Engine Driven
Centrifugal Pump
Model 53H2-VH4D***

THE GORMAN-RUPP COMPANY • MANSFIELD, OHIO

GORMAN-RUPP OF CANADA LIMITED • ST. THOMAS, ONTARIO, CANADA

Printed in U.S.A.

Copyright by the Gorman-Rupp Company



This Installation, Operation, and Maintenance Manual is designed specifically to help you get the best performance and longest life from your Gorman-Rupp pump.

This pump is a 50 Series, enclosed impeller, centrifugal model. It is specifically designed for the pumping of clean liquids at high heads and high discharge pressures.

If there are any questions regarding the pump which are not covered in this manual or in other literature accompanying the unit, please contact your Gorman-Rupp distributor, or write:

- The Gorman-Rupp Company Gorman-Rupp of Canada Limited
P.O. Box 1217 70 Burwell Road
Mansfield, Ohio 44902 St. Thomas, Ontario N5P 3R7

For information or technical assistance on the power source, contact the power source manufacturer's local dealer or representative.

The following are used to alert maintenance personnel to procedures which require special attention, to those which could damage equipment, and to those which could be dangerous to personnel:

NOTE

Instructions to aid in installation, operation, or maintenance or which clarify a procedure.

CAUTION

Instructions which must be followed to avoid causing damage to the product or other equipment incidental to the installation. These describe the procedure required and the damage which could result from failure to follow the procedure.

WARNING

Instructions which must be followed to avoid causing injury or death to personnel. These describe the procedure required and the injury which could result from failure to follow the procedure.

TABLE OF CONTENTS

WARNINGS	Section A
INSTALLATION	Section B
OPERATION	Section C
TROUBLESHOOTING	Section D
MAINTENANCE AND REPAIR	Section E
WARRANTY	

WARNINGS

THESE WARNINGS APPLY TO ALL ENGINE DRIVEN PUMPS. REFER TO THE MANUAL ACCOMPANYING THE ENGINE BEFORE ATTEMPTING TO START THE ENGINE.

Before attempting to open or service the pump:

1. Familiarize yourself with this manual.
2. Disconnect the power source to ensure that the pump will remain inoperative.
3. Allow the pump to cool if overheated.
4. Vent the pump slowly and cautiously.
5. Close the suction and discharge valves.
6. Check the temperature before opening any covers, plates, or plugs.
7. Drain the pump.

Do not attempt to pump volatile or corrosive materials for which this pump has not been designed.

After the pump has been located in its operating position, make certain that the pump has been secured before attempting to operate it.

Do not operate the pump without shields and/or guards in place over drive shafts, belts and/or couplings, or other rotating parts. Exposed rotating parts can catch clothing, fingers, or tools, causing severe injury to personnel.

Do not operate the pump against a closed discharge valve for long periods of time. This could bring the liquid to a boil, build pressure, and cause the pump to rupture or explode.

Overheated pumps can cause severe burns and injury. If overheating of the pump casing occurs:

1. Stop the pump immediately.
2. Allow the pump to cool.
3. Refer to instructions in this manual before restarting the pump.

Do not remove plates, covers, gauges, pipe plugs, or fittings from an overheated pump. Vapor pressure within the pump can cause parts being disengaged to be ejected with great force. Allow the pump to cool before servicing.

Do not operate an internal combustion engine in an explosive atmosphere. When operating internal combustion engines in an enclosed area, make certain that exhaust fumes are piped to the outside. These fumes contain carbon monoxide, a deadly gas that is colorless, tasteless, and odorless.

Fuel used by internal combustion engines presents an extreme explosion and fire hazard. Make certain that all fuel lines are securely connected and free of leaks. Never refuel a hot or running engine. Avoid overfilling the fuel tank. Always use the correct type of fuel.

Never tamper with the governor to gain more power. The governor establishes safe operating limits that should not be exceeded.

INSTALLATION

Seldom are two pump installations identical. The information presented in this section is a summary of the recommended installation practices related to inspection, pump positioning, hardware, suction and discharge piping, and sumps. For further assistance, contact your Gorman-Rupp distributor or the Gorman-Rupp Company.

PREINSTALLATION INSPECTION

The pump assembly was inspected and tested before it was shipped from the factory. Before installation, inspect the pump for damage which may have occurred during shipment. Check as follows:

- a. Inspect the pump assembly for cracks, dents, damaged threads, and other obvious damage.
- b. Check for and tighten loose bolts, nuts, cap screws, and other attaching hardware. Since gaskets tend to shrink after drying, check for and tighten loose nuts and cap screws securing mating surfaces.
- c. Carefully read all tags, decals, and markings on the pump assembly, and perform all duties indicated. Note the direction of rotation indicated on the pump.
- d. Check all lubricant levels and lubricate as necessary. Refer to the MAINTENANCE AND REPAIR section of this manual.

POSITIONING THE PUMP

Mounting

Locate the pump in an accessible place as close as practical to the liquid to be pumped. Level mounting is essential for proper operation. The pump may have to be supported to provide for level operation or to eliminate vibration.

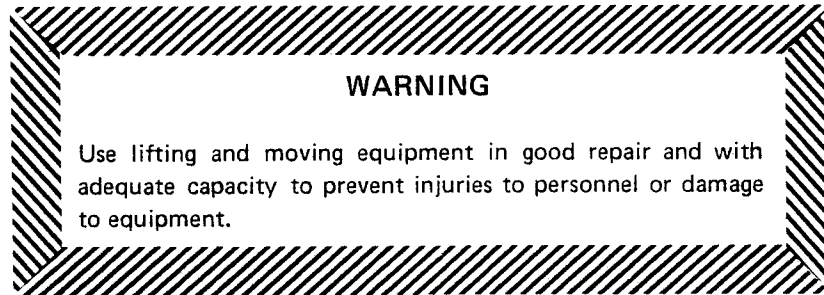
Lifting

Make sure that hoists and other lifting equipment are of sufficient capacity to safely handle the pump assembly. If chains and cables are used, make certain that they are positioned so that they will not damage the pump, and so that the load will be balanced.

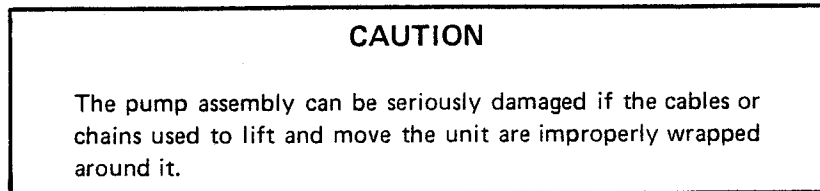
**SUCTION AND DISCHARGE PIPING****Materials**

Either pipe or hose may be used for suction and discharge lines, but hose used in suction lines must be the rigid-wall, reinforced type to prevent collapse under suction. Using pipe couplings in suction lines is not recommended.

Line Configuration

Keep suction and discharge lines as straight as possible to minimize friction losses. Make minimum use of elbows and fittings, which substantially increase friction loss. If elbows are necessary, use the long-radius type to minimize friction loss.

Connections to Pump

Never pull a pipe line into place by tightening the flange bolts. The connecting flange must be aligned exactly with the pump port. Lines near the pump must be independently supported to avoid strain on the pump which could cause serious vibration, decreased bearing life, and increased shaft and seal wear. Hose-type lines should have supports strong enough to secure the line when it is filled with liquid and under pressure.

Gauges

Most pumps are drilled and tapped for installing discharge pressure and vacuum suction gauges. If these gauges are desired for pumps that are not tapped, drill and tap the suction and discharge lines close to the pump before installing the lines.

SUCTION LINES

To avoid air pockets which could affect pump priming, the suction line must be as short and direct as possible. When operation involves a suction lift, the line must always slope upward to the pump from the source of the liquid being pumped; if the line slopes down to the pump at any point along the suction run, air pockets will be created.

Fittings

Suction lines should be the same size as the pump inlet. If reducers are used in suction lines, they should be the eccentric type, and should be installed with the flat part of the reducers uppermost to avoid creating air pockets. Valves are not normally used in suction lines, but if a valve is used, install it with the stem down or to either side to avoid air pockets.

Strainers

Install a strainer at the end of the suction line to avoid possible clogging or damage to the pump. The total area of the openings in the strainer should be at least three or four times the cross section of the suction line, but no opening should be larger than the solids handling capability of the pump. Clean the strainer regularly during operation.

Sealing

All connections in the suction line should be sealed with pipe dope to ensure an airtight seal. Even a slight leak will affect priming, head, and capacity, especially when operating with a high suction lift. After installation, inspect the suction line carefully for potential leaks.

DISCHARGE LINES

Throttling Valves

If a throttling valve is desired, install it in the discharge line. Use a valve as large as the largest pipe in the line to minimize friction losses. Never install a throttling valve in the suction line.

Check Valves

A check valve in the discharge line is normally recommended, but is not necessary in low discharge head applications.

With high discharge heads, install a throttling valve and a check valve in the discharge line to protect the pump from excessive shock pressure and reverse rotation when it is stopped.

Do not terminate the discharge line at a level lower than that of the liquid being pumped unless a siphon breaker is used in the line. Otherwise, a siphoning action could result, causing damage to the pump.

SUCTION LINE POSITIONING

The depth of submergence of the suction line is critical to efficient pump operation. Figure 1 shows recommended minimum submergence vs. velocity.

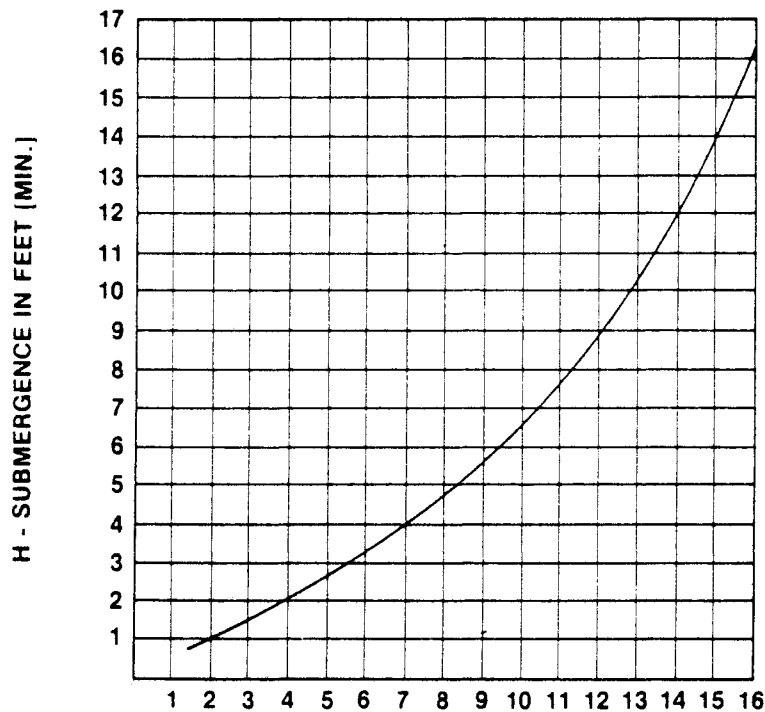

$$\text{VELOCITY IN FEET PER SEC.} = \frac{\text{QUAN. [G.P.M.] x .321}}{\text{AREA}} \text{ OR } \frac{\text{G.P.M. x .4085}}{D^2}$$

Figure 1. Recommended Minimum Suction Line Submergence Vs. Velocity

OPERATION

WARNING

Do not attempt to pump volatile or corrosive materials for which this pump has not been designed.

PRIMING

Install the pump and piping as described in INSTALLATION. Make sure that the piping connections are tight, and that the pump is securely mounted. Check that the pump is properly lubricated (see LUBRICATION in MAINTENANCE AND REPAIR).

Since this pump is not self-priming, it is equipped with an exhaust primer.

Exhaust Primer

In the exhaust primer, engine exhaust gases are directed through a venturi to create a vacuum and draw air out of the suction line and the volute.

The exhaust primer is capable of priming a pump with a 20-foot suction lift in about two minutes; less time will be required for priming at a lesser lift. If the pump does not prime in a reasonable length of time, check the suction line for leaks.

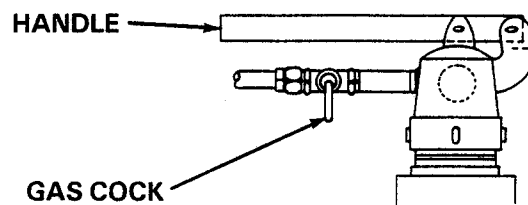

Figure 1. Exhaust Primer Assembly



Close the discharge line throttling valve.

Close the spring-loaded check valve in the discharge line before engaging the exhaust primer.

To prime the pump, close the exhaust primer handle (see figure 1), and open the cock in the priming line. Consult the operating manual furnished with the engine, and start the engine. Allow the pump to prime until liquid flows continuously from the exhaust primer nozzle. When the pump is fully primed, open the exhaust primer handle, and close the cock in the priming line.

Open the spring-loaded check valve in the discharge line. Partially open the discharge throttling valve so that the discharge line fills slowly to prevent damage to piping, gaskets, and other devices in the line which could be affected by shock resulting from rapid filling of the line. When the discharge line is completely filled, adjust the discharge throttling valve to the desired flow rate.

Leakage

No leakage should be visible at pump mating surfaces, or at pump connections or fittings. Keep all line connections and fittings tight to maintain maximum pump efficiency.

Overheating

Overheating can occur if the valves in the suction or discharge lines are closed. Operating against closed valves could bring the liquid to a boil, build pressure, and cause the pump to rupture or explode. If overheating occurs, stop the pump and allow it to cool before servicing it. Refill the volute casing with cool liquid.

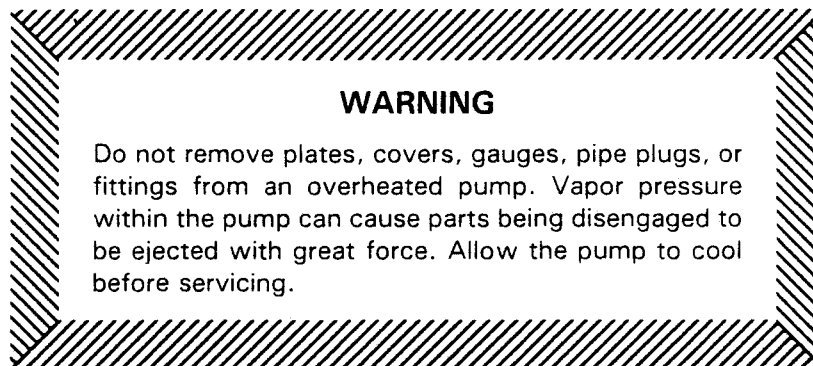

Strainer Check

Check the suction strainer regularly during pump operation, or if the pump flow rate begins to drop, and clean it as necessary. Be especially alert for unusual noises when pumping liquids containing solids.

Pump Vacuum Check

Install a vacuum gauge in the system, using pipe dope on the threads.

The pump should pull a vacuum of 20 inches or more of mercury at operating speed with the suction line blocked. If it does not, check for air leaks in the seals or gaskets.

With the pump primed and at operating speed, and the suction line open, read the vacuum gauge. Shut off the pump, keep the vacuum line open, and read the gauge again to see if the vacuum remains at the maximum developed by the pump. If the vacuum falls off rapidly, an air leak exists. If the liquid level at the source of supply remains at a constant level, check to make certain that the air leak is not from the vacuum gauge connection.

STOPPING

After stopping the pump, disconnect the power source to ensure that the pump will remain inoperative.

In below freezing conditions, drain the pump to prevent damage from freezing. Also, clean out any solids by flushing with a hose. Operate the pump for approximately one minute; this will remove any remaining liquid that could freeze the pump rotating parts.

If the pump will be idle, or if it has been pumping liquids containing a large amount of solids, drain the pump, and flush it thoroughly with clean water. To prevent large solids from clogging the drain port and preventing the pump from completely draining, operate the pump during the draining process. Clean out any remaining solids by flushing with a hose.

TROUBLESHOOTING

WARNING

Before attempting to open or service the pump:

1. Consult pump service manual.
2. Disconnect the power source to ensure that the pump will remain inoperative.
3. Allow pump to cool if overheated.
4. Close suction and discharge valves.
5. Drain pump.

Trouble	Possible Cause	Probable Remedy
PUMP FAILS TO PRIME	<p>Air leak in suction line.</p> <p>Lining of suction hose collapsed.</p> <p>Suction check valve clogged or binding.</p> <p>Leaking or worn seal or pump gasket.</p> <p>Suction lift or discharge head too high.</p> <p>Suction strainer clogged.</p>	<p>Correct leak.</p> <p>Replace suction hose.</p> <p>Clean valve.</p> <p>Check pump vacuum. Replace leaking or worn seal or gasket.</p> <p>Check piping installation and install bypass line if needed. See INSTALLATION.</p> <p>Clean suction strainer.</p>
PUMP STOPS OR FAILS TO DELIVER RATED FLOW OR PRESSURE	<p>Air leak in suction line.</p> <p>Suction intake not submerged at proper level or sump too small.</p> <p>Lining of suction hose collapsed.</p> <p>Impeller or other wearing parts worn or damaged.</p> <p>Impeller clogged.</p> <p>Pump speed too slow.</p> <p>Discharge head too high.</p> <p>Suction lift too high.</p>	<p>Correct leak.</p> <p>Check installation and correct as needed. Check submergence chart (Section B, page 4).</p> <p>Replace suction hose.</p> <p>Check impeller clearance. Replace worn parts as needed.</p> <p>Free impeller of debris.</p> <p>Check driver output.</p> <p>Install bypass line.</p> <p>Reduce suction lift.</p>

Trouble	Possible Cause	Probable Remedy
PUMP STOPS OR FAILS TO DELIVER RATED FLOW OR PRESSURE (cont)	Leaking or worn seal or pump gaskets. Suction strainer clogged.	Check pump vacuum. Replace leaking or worn seal or pump gaskets. Clean suction strainer.
PUMP REQUIRES TOO MUCH POWER	Pump speed too high. Discharge head too low. Liquid solution too thick.	Reduce speed of power source. Adjust discharge valve. Dilute if possible.
PUMP CLOGS FREQUENTLY	Discharge flow too slow. Suction check valve clogged or binding.	Open discharge valve fully to increase flow rate, and run engine at maximum governed speed. Free valve, and clean or replace it.
EXCESSIVE NOISE	Cavitation in pump. Pumping entrained air. Pump or drive not securely mounted. Impeller clogged or damaged.	Reduce suction lift and/or friction losses in suction line. Locate and eliminate source of air bubble. Secure mounting hardware. Clean out debris; replace damaged parts.

Engine Driven Centrifugal Pump Model 53H2-VH4D

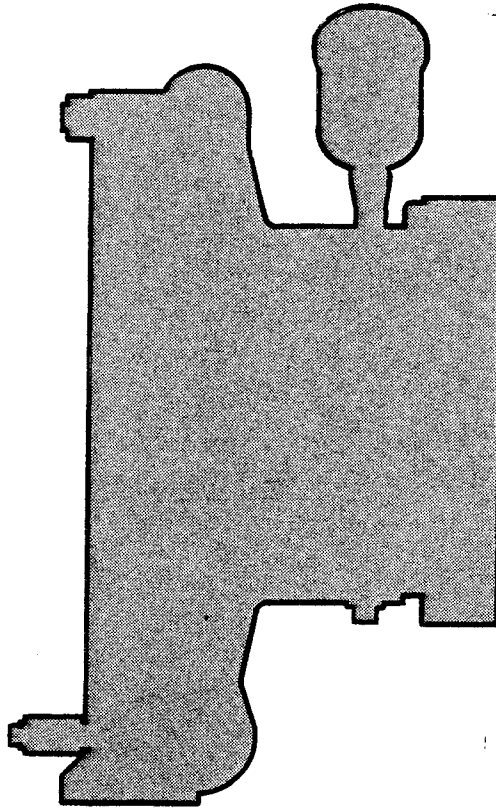

The only moving parts of this pump are the impeller, seal rotating elements, and the shaft. The wear ring, impeller, and seal, which receive the most wear, are easily accessible and can be replaced by removing the cover without disturbing the volute casing and piping. Maintenance and replacement of these three parts will maintain the peak operating efficiency of the pump.

SECTIONAL DRAWING

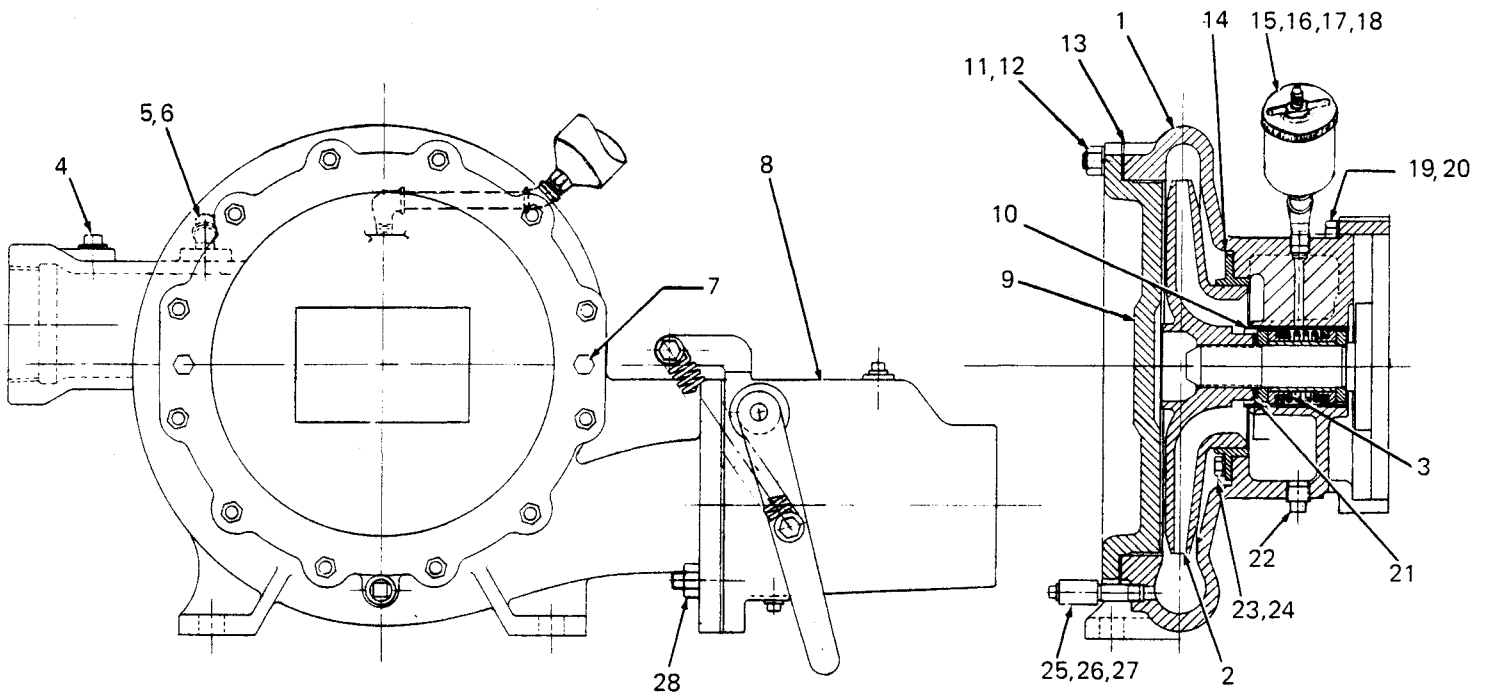

Figure 1. Pump End Only Model 53H2-VH4D



PARTS LIST

PUMP END ONLY MODEL 53H2-VH4D

(From S/N 500372 up)

ITEM NO.	PART NAME	PART NUMBER	MATL CODE	QTY	ITEM NO.	PART NAME	PART NUMBER	MATL CODE	QTY
1	VOLUTE CASING	2201	10010	1	NOT SHOWN:				
2	★IMPELLER	2203	10010	1	STRAINER	S-1569	-	-	1
3	★SEAL ASSEMBLY	GS-1250	-	1	WISCONSIN VH4D ENGINE	202-M2	-	-	1
4	ACCESSORY PLUG	P-08	11990	1	SADDLE STRAP	4062-X	24000	-	2
5	PIPE NIPPLE	2434	15070	1	BASE	5673	24000	-	1
6	STREET ELBOW	AGS-06	11990	1	FUEL TANK BRACKET	5741	15990	-	1
7	HEX HEAD CAPSCREW	B-0604	15991	2	TANK SUPPORT	6559-D	24000	-	2
8	★CHECK VALVE ASSEMBLY	GRP14-01	-	1	FELT STRIP	9490-C	18030	-	2
	ADJUSTING SHIM SET	669-A	17000	1	FLEX OIL LINE	S-515-A	-	-	1
	SPRING BRACKET	3844	14000	1	FUEL TANK	S-563	-	-	1
	CHECK VALVE BODY	3480-A	10010	1	HOSE CLAMP	S-887	-	-	2
	EXTENSION SPRING	3849	16030	1	EP5 EXHAUST PRIMER	GRP15-01	-	-	1
	SPACER	3855	15070	2	VALVE HANDLE	1458	15990	-	1
	PACKING NUT	5252	14100	1	EXHAUST VALVE BODY	1468	10010	-	1
	GASKET	5252-G	18000	1	PRIMING VALVE CAP	1469	10010	-	1
	WEIGHT ARM	5253-A	15990	1	EJECTOR BODY	1602-A	14000	-	1
	SHAFT	5263	17010	1	EJECTOR NOZZLE	1603-A	14000	-	1
	HANDLE	6334	11000	1	PIPE NIPPLE	2434	15070	-	1
	BUSHING	11573	15030	1	COTTER PIN	M-0406	15990	-	2
	VALVE WEIGHT	11588	10010	1	GAS COCK	S-02	-	-	1
	CHECK VALVE GASKET	11589-G	18000	1	SPRING WASHER	S-165	-	-	3
	CHECK VALVE	12391	24010	1	PIPE NIPPLE	T-06	15070	-	1
	HEX HEAD CAPSCREW	B-0604	15991	2	PIPE NIPPLE	T-08	15070	-	1
	HEX HEAD CAPSCREW	B-0606	15991	2	SHUTOFF COCK	26661-351	-	-	1
	STUD	C-1009	15991	4	RUBBER HOSE	31412-103	-	-	1
	HEX NUT	D-10	15991	4	INSTRUMENT PANEL ASSEMBLY	48312-805	-	-	1
	LOCKWASHER	J-06	15991	4	WIRE ASSEMBLY	5795-G	-	-	1
	FLAT WASHER	K-06	15991	2	WIRE ASSEMBLY	5795-H	-	-	1
	PIPE PLUG	P-04	11990	2	WIRE ASSEMBLY	5795-J	-	-	1
	ROLL PIN	S-0630	-	2	WIRE ASSEMBLY	5795-Z	-	-	1
	O-RING	S-0942	-	1	INSTRUMENT PANEL	6363-B	15990	-	1
	NYLOCK CAPSCREW	BT-0806 1/2	15991	1	PRESSURE LINE CLIP	6450	15990	-	1
	FLAT WASHER	KE-08	15991	2	FLAT WASHER	K-04	15991	-	1
	DRIV-LOK PIN	21142-445	-	1	NUT	S-293	-	-	2
9	COVER PLATE	2202-C	10010	1	FEMALE CONNECTOR	S-577	-	-	1
10	★SEAL LINER	2205	14080	1	TUBE FITTING	S-634	-	-	1
11	STUD	C-0807	15991	12	FITTING	S-698	-	-	1
12	HEX NUT	D-08	15991	12	PUSH STOP SWITCH	S-783	-	-	1
13	★COVER GASKET	2202-G	18000	1	GROMMET	S-807	-	-	4
14	★IMPELLER WEAR RING	2204	14000	1	SAFETY SWITCH	S-948	-	-	1
15	PIPE ELBOW	AG-04	11990	1	COMBINATION SAFETY SWITCH	S-971	-	-	1
16	PIPE NIPPLE	T-0416	15070	1	FLEX HOSE ASSEMBLY	S-1003	-	-	1
17	STREET ELBOW	RS-04	11990	1	OIL PRESSURE GAUGE	S-1588	-	-	1
18	★SEAL GREASE CUP	S-1509	-	1	COPPER TUBING	W-4152	14990	-	1
19	HEX HEAD CAPSCREW	B-0709	15991	4	PAN HEAD TAPSCREW	BP#14-02	15991	-	4
20	LOCKWASHER	J-07	15991	4	MOUNTING HARDWARE				
21	★IMPELLER SHIM SET	37-J	17090	1	MACHINE BOLT	A-1007	15991	-	2
22	VOLUTE DRAIN PLUG	P-06	11990	1	HEX HEAD CAPSCREW	B-0810	15991	-	2
23	HEX HEAD CAPSCREW	B-0503	14990	2	HEX NUT	D-08	15991	-	4
24	LOCKWASHER	J-05	15991	2	HEX NUT	D-10	15991	-	2
25	PIPE NIPPLE	T-0606	15070	1	LOCKWASHER	J-08	15991	-	4
26	PIPE COUPLING	AE-06	11990	1	LOCKWASHER	J-10	15991	-	2
27	VOLUTE DRAIN PLUG	P-06	11990	1	OPTIONAL:				
28	HEX NUT	D-10	15991	4	WHEEL KIT	GRP30-08			

★ INDICATES PARTS RECOMMENDED FOR STOCK
Above Serial Numbers Do Not Apply To Pumps Made In Canada.

CANADIAN SERIAL NO. AND UP

PUMP AND SEAL DISASSEMBLY AND REASSEMBLY

This pump requires little service due to its rugged, minimum-maintenance design. If it becomes necessary to inspect and/or replace the wearing parts, however, follow these instructions, which are keyed to the sectional view (see figure 1) and the accompanying parts list.

Pump Disassembly

Disconnect the power source, making certain that it will remain inoperative while the pump is being serviced, and close all connecting valves. Remove the volute drain plugs (22 and 27) to drain the pump.

Remove the hex nuts (12) securing the cover plate (9) to the volute casing (1) for access to the wear ring (14), impeller (2), and seal assembly (3).

To remove the impeller, block the shaft or power source to prevent rotation, and using an impeller wrench, turn the impeller in the direction of pump rotation. Unscrew the impeller and replace it if scored or badly worn.

Remove the impeller adjusting shims (21). For ease of reassembly, tag and tie the shims, or measure and record their thickness.

Inspect the wear ring, and replace it if scored or worn.

Seal Disassembly

Before removing the seal assembly, turn the cross arm on the seal grease cup (18) clockwise until it rests against the cover (see figure 3). This will prevent the grease in the cup from escaping after the seal is removed.

Carefully remove the seal spring, the shaft sleeve, and the stationary and rotating seal elements, using a stiff wire with a hooked end if necessary. Remove the seal liner (10), which is a press fit.

Clean the seal cavity and shaft with a soft cloth soaked in cleaning solvent.

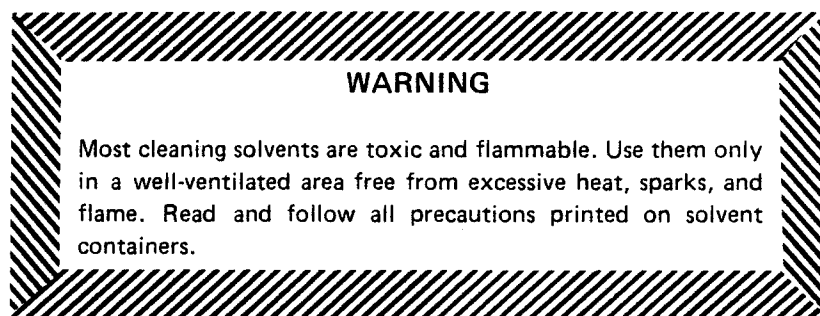
**Seal Reassembly**

The seal is not normally reused because of the high polish on its lapped faces, but if it is necessary to reuse the old seal, wash all metallic parts in cleaning solvent and dry thoroughly.

Inspect the seal components for wear, scoring, grooves, and other damage that might cause leakage. If any components are worn, replace the complete seal; never mix old and new seal parts. Clean and polish the shaft sleeve, or replace it if there are nicks or cuts on the end.

Replace the seal liner if worn or grooved. If the seal liner is replaced, a hole must be drilled in it after installation to permit the flow of lubricant from the grease cup to the seal assembly. Deburr the hole after drilling, and clean the seal liner.

CAUTION

This seal is not designed for operation at temperatures above 110°F. Do not use at higher operating temperatures.

Reinstall the shaft sleeve, and install the replacement seal as a complete unit.

Lubricate the packing rings with soft grease or oil when installing the seal, and place a drop of light lubricating oil on the lapped faces. Assemble the seal as shown in figure 2.

Before starting the pump, fill the grease cup through the grease fitting with a good grade of No. 2 pressure gun grease until grease escapes from the relief hole. Turn the grease cup arm counterclockwise until it is at the top of the stem; this will release the spring to apply grease to the seal (see figure 3).

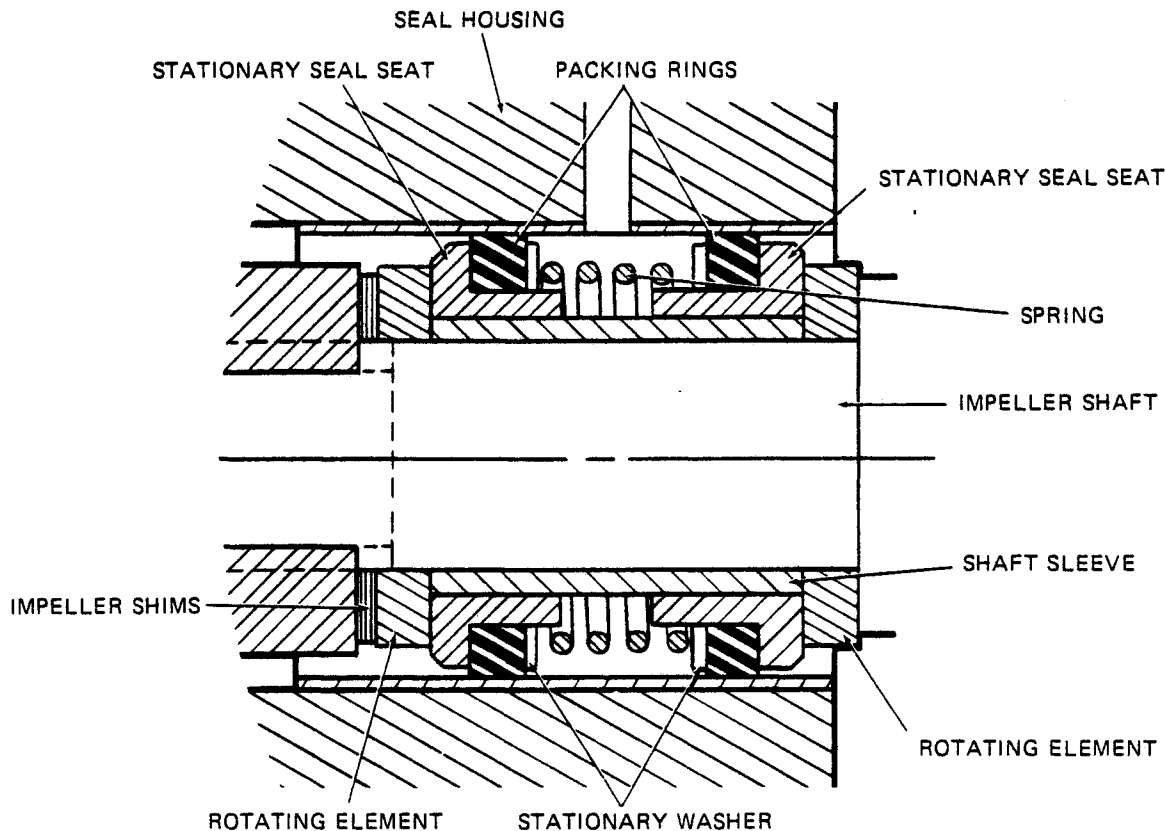

Figure 2. GS-1250 Seal Assembly

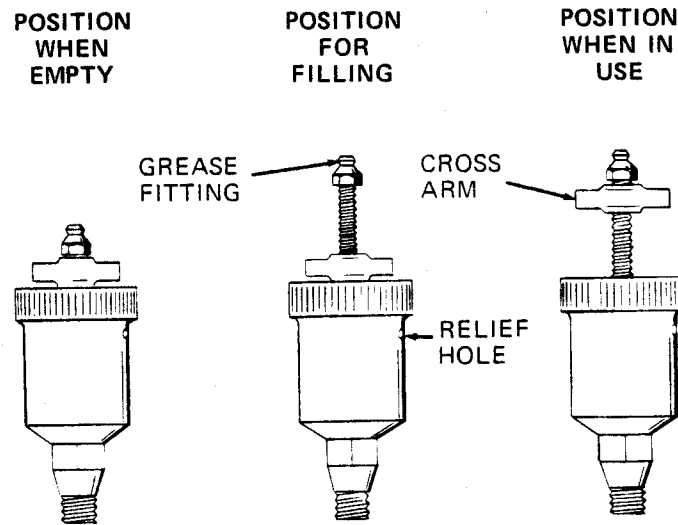

Figure 3. Automatic Lubricating Grease Cup

Pump Reassembly

Reinstall the impeller adjusting shims and the impeller. It is necessary for the impeller to be centered in the volute scroll for maximum pump efficiency. Measure this clearance and add or subtract impeller shims until it is reached.

Reassemble the cover plate to the volute casing, replacing the cover gasket (13).

Before starting the pump, turn the impeller shaft to be sure the impeller does not bind or scrape.

Clean and reinstall the volute drain plugs.

LUBRICATION

Seal Assembly

Before starting the pump, fill the grease cup through the grease fitting with a good grade of No. 2 pressure gun grease until grease escapes from the relief hole. Turn the grease cup arm counterclockwise until it is at the top of the stem; this will release the spring to apply grease to the seal (see figure 3).

**For U.S. and International Warranty Information,
Please Visit www.grpumps.com/warranty
or call:
U.S.: 419-755-1280
International: +1-419-755-1352**

**For Canadian Warranty Information,
Please Visit www.grcanada.com/warranty
or call:
519-631-2870**