

INSTALLATION, OPERATION, PARTS LIST,
AND MAINTENANCE MANUAL

Q



OM-01251-0P02

March 17, 1982

Rev. A

A large, stylized outline of a pump housing, serving as a background for the title text. The outline shows the main body of the pump, a top flange with a central bolt, and a bottom section that tapers out.

Power Take Off
Self-Priming
Centrifugal Pump
Model 06C15-GA

THE GORMAN-RUPP COMPANY • MANSFIELD, OHIO
GORMAN-RUPP OF CANADA LIMITED • ST. THOMAS, ONTARIO, CANADA

Printed in U.S.A.

Copyright by the Gorman-Rupp Company

This Installation, Operation, and Maintenance Manual is designed to help you get the best performance and longest life from your Gorman-Rupp pump.

This pump is an O Series, enclosed impeller, self-priming centrifugal model without a suction check valve. The pump is designed primarily for handling petroleum liquids, but is also suitable for pumping liquids which do not contain large solids.

If there are any questions regarding the pump which are not covered in this manual or in other literature accompanying the unit, please contact your Gorman-Rupp distributor, or write:

The Gorman-Rupp Company	or	Gorman-Rupp of Canada Limited
P.O. Box 1217		70 Burwell Road
Mansfield, Ohio 44902		St. Thomas, Ontario N5P 3R7

The following are used to alert maintenance personnel to procedures which require special attention, to those which could damage equipment, and to those which could be dangerous to personnel:

NOTE

Instructions to aid in installation, operation, or maintenance or which clarify a procedure.

CAUTION

Instructions which must be followed to avoid causing damage to the product or other equipment incidental to the installation. These describe the procedure required and the damage which could result from failure to follow the procedure.

WARNING

Instructions which must be followed to avoid causing injury or death to personnel. These describe the procedure required and the injury which could result from failure to follow the procedure.

TABLE OF CONTENTS

WARNINGS	Section A
INSTALLATION	Section B
OPERATION	Section C
TROUBLESHOOTING	Section D
MAINTENANCE AND REPAIR	Section E
WARRANTY	

WARNINGS

THESE WARNINGS APPLY TO O SERIES PUMPS WITH POWER TAKE OFF DRIVE

Before attempting to open or service the pump:

1. Familiarize yourself with this manual.
2. Shut off the power source ignition to ensure that the pump will remain inoperative.
3. Allow the pump to cool if overheated.
4. Vent the pump slowly and cautiously.
5. Close the suction and discharge valves.
6. Check the temperature before opening any covers, plates, or plugs.
7. Drain the pump.

This pump is designed primarily to handle specific volatile and/or flammable liquids. Do not attempt to pump any liquids for which this pump has not been designed.

This pump is usually installed in a permanent configuration. After the pump has been installed, make certain that the pump and all piping connections are secure before attempting to operate it.

Do not operate the pump against a closed discharge valve for long periods of time. This could bring the liquid to a boil, build pressure, and cause the pump to rupture or explode.



Overheated pumps can cause severe burns and injury. If overheating of the pump casing occurs:

1. Stop the pump immediately.
2. Allow the pump to cool.
3. Refer to instructions in this manual before restarting the pump.

Do not remove plates, covers, gauges, pipe plugs, or fittings from an overheated pump. Vapor pressure within the pump can cause parts being disengaged to be ejected with great force. Allow the pump to cool before servicing.

Overheating may produce dangerous fumes. Use extreme caution when venting the pump, or when removing covers, plates, plugs or fittings.

Take precautions to ensure that adequate ventilation is provided, and that adequate protective clothing is worn, while the pump is being serviced.

INSTALLATION

Since pump installations vary, this section is intended only to summarize recommended installation practice. If there are any questions concerning a specific installation, contact your Gorman-Rupp distributor or the Gorman-Rupp Company.

PREINSTALLATION INSPECTION

The pump assembly was inspected and tested before it was shipped from the factory. Before installation, inspect the pump for damage which may have occurred during shipment.

a. Check the pump assembly for cracks, dents, damaged threads, and other obvious damage.

b. Check for and tighten loose bolts, nuts, cap screws, and other attaching hardware. Since gaskets tend to shrink after drying, check for and tighten loose nuts and cap screws securing mating surfaces.

c. Carefully read all tags, decals, and markings on the pump assembly, and perform all duties indicated. Note the direction of rotation indicated on the pump. Check that the pump shaft rotates in the required direction.

CAUTION

Only operate this pump in the direction indicated by the arrow on the pump body and on the accompanying decal. Otherwise, the impeller could become loosened from the shaft and seriously damage the pump.

d. Check all lubricant levels and lubricate as necessary. Refer to the MAINTENANCE AND REPAIR section of this manual.

Lifting

WARNING

Use lifting and moving equipment in good repair and with adequate capacity to prevent injuries to personnel or damage to equipment.

Make sure that hoists and other lifting equipment are of sufficient capacity to safely handle the pump assembly. If chains or cables must be used, make certain that they are positioned so that they will not damage the pump, and so that the load will be balanced.



CAUTION

The pump assembly can be seriously damaged if the cables or chains used to lift and move the unit are improperly wrapped around it.

SUCTION AND DISCHARGE PIPING

Materials

This pump is usually installed in a permanent piping configuration, but either pipe or hose may be used for suction and discharge lines. Piping materials must be compatible with the liquid being pumped. If hose is used in suction lines, it must be the rigid-wall, reinforced type to prevent collapse under suction. Using pipe couplings in suction lines is not recommended.

Line Configuration

Keep suction and discharge lines as straight as possible to minimize friction losses. Make minimum use of elbows and fittings, which substantially increase friction loss. If elbows are necessary, use the long-radius type to minimize friction loss.

Connections to Pump

Before tightening a connecting flange, align it exactly with the pump port. Never pull a pipe line into place by tightening the flange bolts.

Lines near the pump must be independently supported to avoid strain on the pump which could cause excessive vibration, decreased bearing life, and increased shaft and seal wear. If hose-type lines are used, they should have adequate support to secure them when filled with liquid and under pressure.

SUCTION LINES

To avoid air pockets which could affect pump priming, the suction line must be as short and direct as possible. When operation involves a suction lift, the line must always slope upward to the pump from the source of the liquid being pumped; if the line slopes down to the pump at any point along the suction run, air pockets will be created.

Fittings

Suction lines should be the same size as the pump inlet. If reducers are used in suction lines, they should be the eccentric type, and should be installed with the flat part of the reducers uppermost to avoid creating air pockets. Valves are not normally used in suction lines, but if a valve is used, install it with the stem horizontal to avoid air pockets.

Strainers

If a strainer is installed by the pump user, make certain that the total area of the openings in the strainer is at least three or four times the cross section of the suction line, and that the openings will not permit passage of solids larger than the solids handling capability of the pump.

Sealing

Since even a slight leak will affect priming, head, and capacity, all connections in the suction line should be sealed with pipe dope to ensure an airtight seal. In volatile and/or flammable service, the pipe dope should be compatible with the liquid being pumped.

Valves

If a throttling valve is desired in the discharge line, use a valve as large as the largest pipe in the line to minimize friction losses. Never install a throttling valve in a suction line.

A check valve in the discharge line is normally recommended, but is not necessary in low discharge head applications.

It is recommended that a throttling valve and a check valve be installed in the discharge line to protect the pump from excessive shock pressure and reverse rotation when it is stopped.

ALIGNMENT

When this pump is shipped from the Gorman-Rupp factory, the pump and gearbox are securely attached. The attaching hex nuts may become loosened in transit and handling, however, and should be checked before the pump is put into service.

CAUTION

Before operating this pump, make certain that the hex nuts securing the pump to the gearbox are fully tightened.

OPERATION

WARNING

This pump is designed primarily to handle specific volatile and/or flammable liquids. Do not attempt to pump any volatile and/or flammable liquids for which this pump has not been designed.

PRIMING

Install the pump and piping as described in INSTALLATION. Make sure that the piping connections are tight, and that the pump is securely mounted. Check that the pump is properly lubricated (see LUBRICATION in MAINTENANCE AND REPAIR).

Although this pump is self-priming, it should never be operated unless any valves in the suction line are open, and the volute is filled with liquid.

CAUTION

Never operate this pump unless the volute is filled with liquid. The pump will not prime when dry. Extended operation of a dry pump will destroy the seal assembly.

When the volute housing is filled with liquid, the pump will prime and reprime as necessary.

WARNING

Do not attempt to operate the pump unless all connecting piping is securely installed. Otherwise, liquid in the pump forced out under pressure could cause injury to personnel.

STARTING

Rotation

The correct direction of pump rotation is indicated by an arrow on the pump body, and on the accompanying decal. If the pump is operated in the wrong direction, the impeller could become loosened from the shaft and seriously damage the pump.

CAUTION

Only operate this pump in the direction indicated by the arrow on the pump body and on the accompanying decal. Otherwise, the impeller could become loosened from the shaft and seriously damage the pump.

Piping Valves

Open all valves in the suction and discharge line and engage the pump drive. Priming is indicated by a positive reading on the discharge pressure gauge, or by quieter operation. If the pump fails to prime within five minutes, stop it and check the suction line for leaks.

After the pump has primed, partially close the discharge throttling valve in order to fill the line slowly and guard against excessive shock pressure which would damage pipe ends, gaskets, and any other fixtures connected to the line. When the discharge line is completely filled, adjust the throttling valve to the required discharge flow rate.

Leakage

No leakage should be visible at pump mating surfaces, or at pump connections or fittings. Keep all line connections and fittings tight to maintain maximum pump efficiency.

Overheating

Overheating can occur if the valves in the suction or discharge lines are closed. Operating against closed valves could bring the liquid to a boil, build pressure, and cause the pump to rupture or explode. If overheating occurs, stop the pump and allow it to cool before servicing it.

WARNING

Do not remove plates, covers, gauges, pipe plugs, or fittings from an overheated pump. Vapor pressure within the pump can cause parts being disengaged to be ejected with great force. Allow the pump to cool before servicing.

WARNING

Overheating may produce dangerous fumes. Use extreme caution when venting the pump, or when removing covers, plates, plugs or fittings.



Strainer Check

If a suction strainer has been installed by the user, check the strainer regularly, and clean it as necessary. The strainer should also be checked if pump flow rate begins to drop.

Pump Vacuum Check

Since this pump does not have a suction check valve, the discharge line must be fitted with a check valve if a pump vacuum reading is to be taken.

With the pump inoperative, install a vacuum gauge in the system, using pipe dope on the threads. Block the suction line and start the pump. At operating speed the pump should pull a vacuum of 20 inches or more of mercury. If it does not, check for air leaks in the seal or gasket.

Open the suction line, and read the vacuum gauge with the pump primed and at operating speed. Shut off the pump. The vacuum gauge reading will immediately drop proportionately to static suction lift, and should then stabilize. If the vacuum reading falls off rapidly after stabilizing, an air leak exists. Before checking the lines for the source of the air leak, check the point of installation of the vacuum gauge.

Stopping

After stopping the pump, shut off the power source ignition to ensure that the pump will remain inoperative.

In below-freezing conditions in other than petroleum service, drain the pump to prevent damage from freezing, and clean out any solids by flushing with a hose. Operate the pump for approximately one minute; this will remove any remaining liquid that could freeze the pump rotating parts.

If the pump will be idle for more than a few hours, or if it has been pumping liquids containing a large amount of solids, drain the pump, and flush it thoroughly with clean water. Operate the pump during the draining process.

Unless they are extremely severe, below-freezing conditions will not affect pump operation in petroleum service.

BEARING TEMPERATURE CHECK

Bearings normally run at higher than ambient temperatures because of heat generated by friction. Temperatures up to 160°F are considered normal for pedestal bearings, and they can operate safely to at least 180°F.

Checking bearing temperatures by hand is inaccurate. Bearing temperatures can be measured accurately by placing a contact-type thermometer against the housing. Record this temperature for future reference.

A sudden increase in bearing temperatures is a warning that the bearings are at the point of failing to operate properly. Make certain that the bearing lubricant is of the proper viscosity and at the correct level (see LUBRICATION in MAINTENANCE AND REPAIR). Bearing overheating can also be caused by shaft misalignment and/or excessive vibration.

When pumps are first started, the bearings may seem to run at temperatures above normal. Operation should bring the temperatures down to normal levels.

TROUBLESHOOTING

WARNING

Before attempting to open or service the pump:

1. Familiarize yourself with this manual.
2. Shut off the power source ignition to ensure that the pump will remain inoperative.
3. Allow pump to cool if overheated.
4. Vent the pump slowly and cautiously.
5. Close the suction and discharge valves.
6. Check the temperature before opening any covers, plates, or plugs.
7. Drain the pump.

Trouble	Possible Cause	Probable Remedy
PUMP FAILS TO PRIME	Air leak in suction line. Lining of suction hose collapsed. Leaking or worn seal or pump gasket.	Correct leak. Replace suction hose. Check pump vacuum. Replace leaking or worn seal or gasket.
PUMP STOPS OR FAILS TO DELIVER RATED FLOW OR PRESSURE	Air leak in suction line. Lining of suction hose collapsed. Impeller or other wearing parts worn or damaged. Impeller clogged. Pump speed too slow. Strainer clogged. Leaking or worn seal or pump gaskets.	Correct leak. Replace suction hose. Replace worn or damaged parts. Check that impeller is properly centered and rotates freely. Free impeller of debris. Check driver output; check belts or couplings for slippage. Check strainer and clean if necessary. Check pump vacuum. Replace leaking or worn seal or pump gaskets.



Trouble	Possible Cause	Probable Remedy
PUMP REQUIRES TOO MUCH POWER	Pump speed too high. Discharge head too low.	Check driver output. Adjust discharge valve.
PUMP CLOGS FREQUENTLY	Discharge flow too slow.	Open discharge valve fully to increase flow rate.
EXCESSIVE NOISE	Cavitation in pump. Pumping entrained air. Pump or drive not securely mounted. Impeller clogged or damaged.	Reduce friction losses in suction line. Locate and eliminate source of air bubble. Secure mounting hardware. Clean out debris; replace damaged parts.
BEARINGS RUN TOO HOT	Bearing temperature is high, but within limits. Low or incorrect lubricant. Suction and discharge lines not properly supported. Drive misaligned.	Check bearing temperature frequently to monitor any increase. Check for proper type and level of lubricant. Check piping installation for proper support. Align drive properly.



MAINTENANCE AND REPAIR

MAINTENANCE AND REPAIR OF THE WEARING PARTS OF THE PUMP WILL MAINTAIN PEAK OPERATING PERFORMANCE.

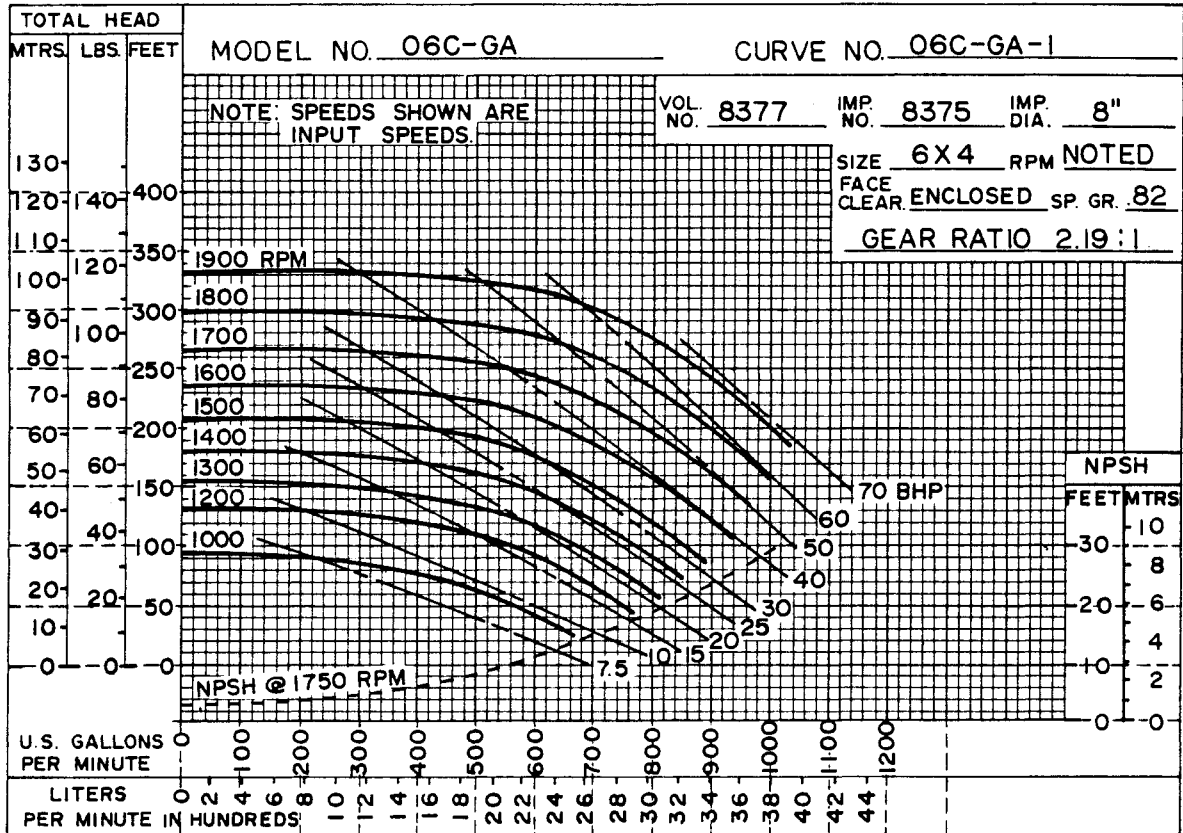

C-11-13-72 REV.

* STANDARD PERFORMANCE FOR PUMP MODEL 06C15-GA

* Based on 70°F clear water at sea level corrected to 0.82 specific gravity with minimum suction lift. Since pump installations are seldom identical, your performance may be different due to such factors as viscosity, specific gravity, elevation, temperature, and impeller trim.

If your pump serial number is followed by an "N" or if you have a question on performance, contact The Gorman-Rupp Company.

SECTIONAL DRAWING

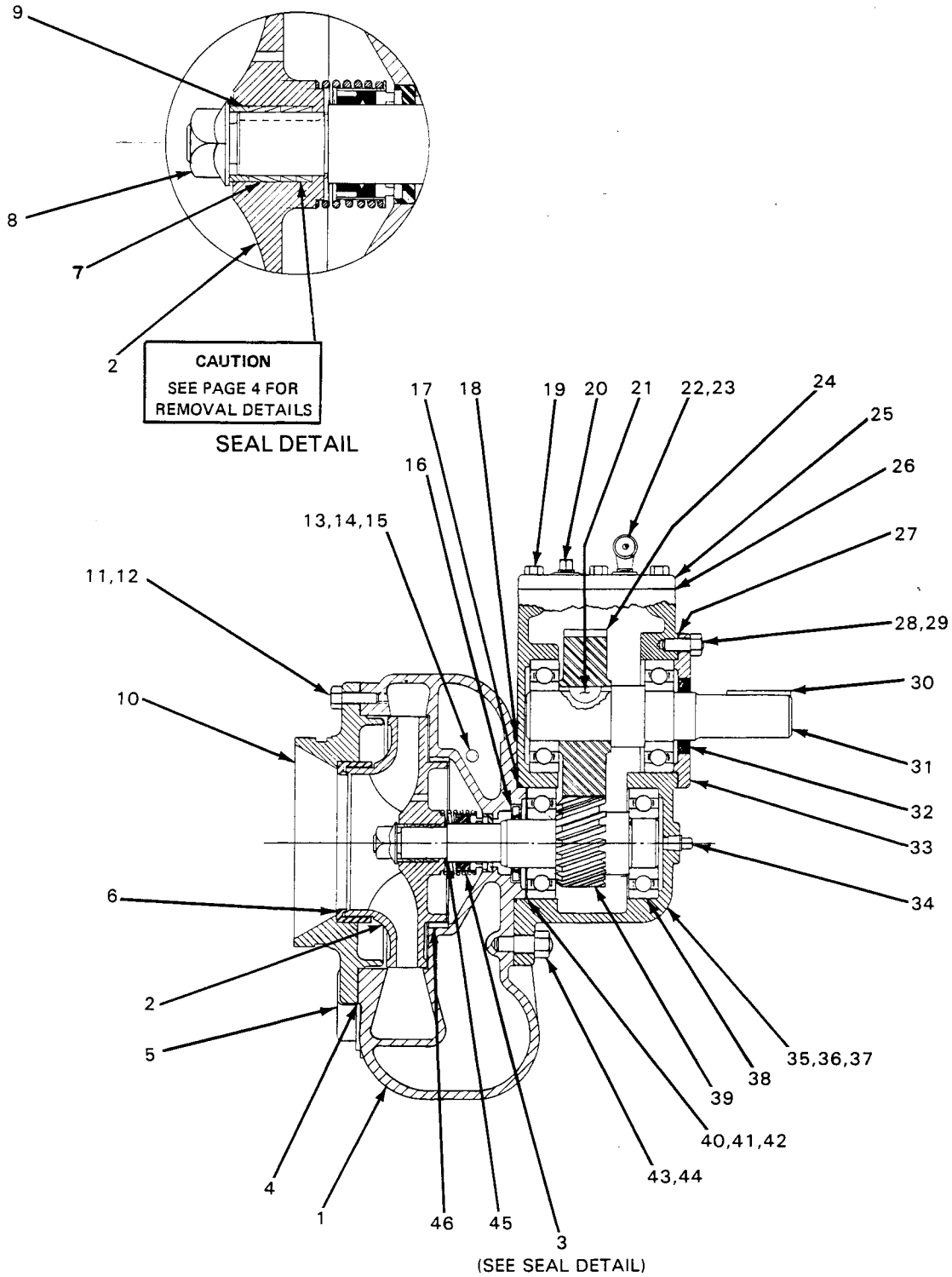

Figure 1. Pump Model 06C15-GA



PARTS LIST
PUMP MODEL 06C15-GA
(From S/N 520951 up)

ITEM NO.	PART NAME	PART NUMBER	MATL CODE	QTY	ITEM NO.	PART NAME	PART NUMBER	MATL CODE	QTY
1	VOLUTE	8377	13040	1	26	★ COVER PLATE GASKET	10210-G	18000	1
2	★ IMPELLER	38624-507	—	1	27	★ BEARING CAP GASKET	10213-G	18000	1
3	★ SEAL ASSEMBLY	25271-192	—	1	28	STUD	C-0605	15991	4
4	★ SUCTION HEAD GASKET	8376-G	20000	1	29	HEX NUT	D-06	15991	4
5	VOLUTE DRAIN PLUG	P-32	11991	1	30	DRIVE SHAFT KEY	N-0508	15990	1
6	★ SUCTION HD WEAR RING	64-H5	10018	1	31	★ DRIVE SHAFT	10209	16040	1
7	LOCKING ELEMENT	24133-025	—	4	32	★ OIL SEAL	S-0506	—	1
8	IMPELLER LOCKNUT	S-2202	—	1	33	BEARING CAP	10213	10010	1
9	IMPELLER SPACER	31143-059	—	1	34	PIPE PLUG	P-06	11990	1
10	SUCTION HEAD	10218	13040	1	35	GEARBOX HOUSING	10200	10010	1
11	STUD	C-0605½	15991	12	36	PIPE PLUG	P-06	11990	1
12	HEX NUT	D-06	15991	12	37	GEARBOX DRAIN PLUG	PM-06	11990	1
13	STUD	C-0606½	15991	8	38	★ BALL BEARING	S-1080	—	4
14	HEX NUT	D-06	15991	8	39	★ PINION SHAFT	10202-B	16070	1
15	★ DISCHARGE FLNG GSKE	5372-G	20000	1	40	★ BEARING SHIM SET	8543	15990	1
16	★ OIL SEAL	S-2007	—	1	41	DOES NOT APPLY			
17	★ VOLUTE O-RING	S-2085	—	1	42	DOES NOT APPLY			
18	★ VOLUTE GASKET	8377-G	18000	1	43	STUD	C-0807	15991	6
19	HEX HEAD CAPSCREW	B-0503	15991	8	44	HEX NUT	D-08	15991	6
20	PIPE PLUG	P-04	11990	1	45	★ IMPELLER SHIM SET	2-X	17090	1
21	DRIVE SHAFT KEY	AV-1009	15990	1	46	★ VOLUTE WEAR RING	8464	10018	1
22	PRESSURE RELIEF FITTING	S-1530	—	1	NOT SHOWN:				
23	STREET ELBOW	RS-02	11990	1		NAME PLATE	2613-AY	13990	1
24	★ DRIVE GEAR	10203	16070	1		DIRECTION PLATE	2613-BM	00000	1
25	COVER PLATE ASSEMBLY	10210-A	24020	1		DRIVE SCREW	BM#04-03	15990	2

★ INDICATES PARTS RECOMMENDED FOR STOCK

CANADIAN SERIAL NO. AND UP

PUMP, SEAL, AND GEARBOX DISASSEMBLY AND REASSEMBLY

This pump requires little service due to its rugged, minimum-maintenance design. If it becomes necessary to inspect or replace components, however, follow these instructions, which are keyed to the sectional view (see figure 1) and the accompanying parts list.

Pump Disassembly

WARNING

Before attempting to open or service the pump:

1. Familiarize yourself with this manual.
2. Disconnect the power source ignition to ensure that the pump will remain inoperative.
3. Allow the pump to cool if overheated.
4. Vent the pump slowly and cautiously.
5. Close the suction and discharge valves.
6. Check the temperature before opening any covers, plates, or plugs.
7. Drain the pump.

The seal assembly and impeller may be serviced with the pump in place. To service the gearbox, the pump should be dismounted.

Disconnect the power source ignition, making certain that it will remain inoperative while the pump is being serviced, and close all connecting valves.

Remove the volute housing drain plug (5) to drain the pump. Remove the gearbox drain plug (37), to drain the gearbox. Clean and reinstall both drain plugs.

For access to the impeller (2) and seal assembly (3), disconnect the suction piping, and remove the suction head (10) and wear ring (6) by disengaging the hex nuts (12).

To remove the impeller, remove the impeller locknut (8) and spacer (9). The locking elements (7) should separate when the locknut and spacer are removed. If the elements jam, loosen them by tapping the end of the shaft lightly with a soft-faced mallet or hammer; use caution not to damage the shaft threads. A stiff wire with a hooked end may be useful in removing the locking elements.

Slide the impeller off the shaft. Use caution when removing the impeller; tension on the seal spring will be released as the impeller is removed.

Remove the impeller adjusting shims (45). For ease of reassembly, tag and tie the shims.

Seal Disassembly

Remove the seal spring. Using a stiff wire with a hooked end, remove the remainder of the seal components.

Clean the seal cavity and shaft with a soft cloth soaked in cleaning solvent.

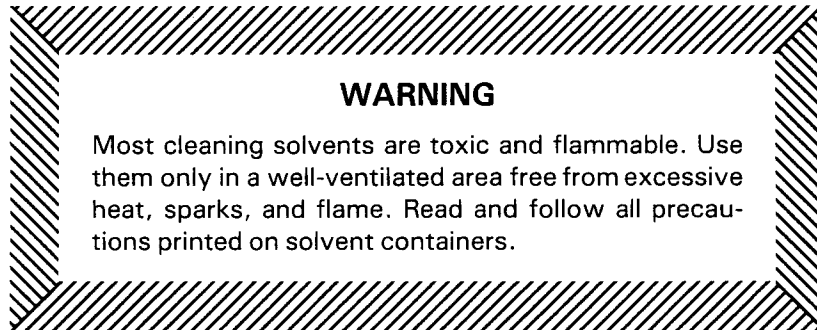
**Seal Reassembly**

If the gearbox is to be serviced or disassembled, do not reassemble the seal or the pump at this time.

The seal is not normally reused because of the high polish on its lapped faces, but if it is necessary to reuse the old seal, wash all metallic parts in cleaning solvent and dry thoroughly.

Inspect the seal components for wear, scoring, grooves, and other damage that might cause leakage. If any components are worn, replace the complete seal; never mix old and new seal parts.

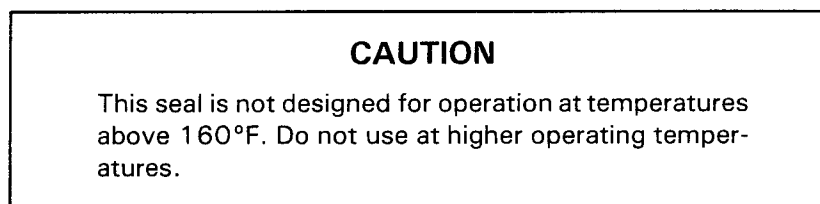

See figure 2 for the correct order of installation of seal components.

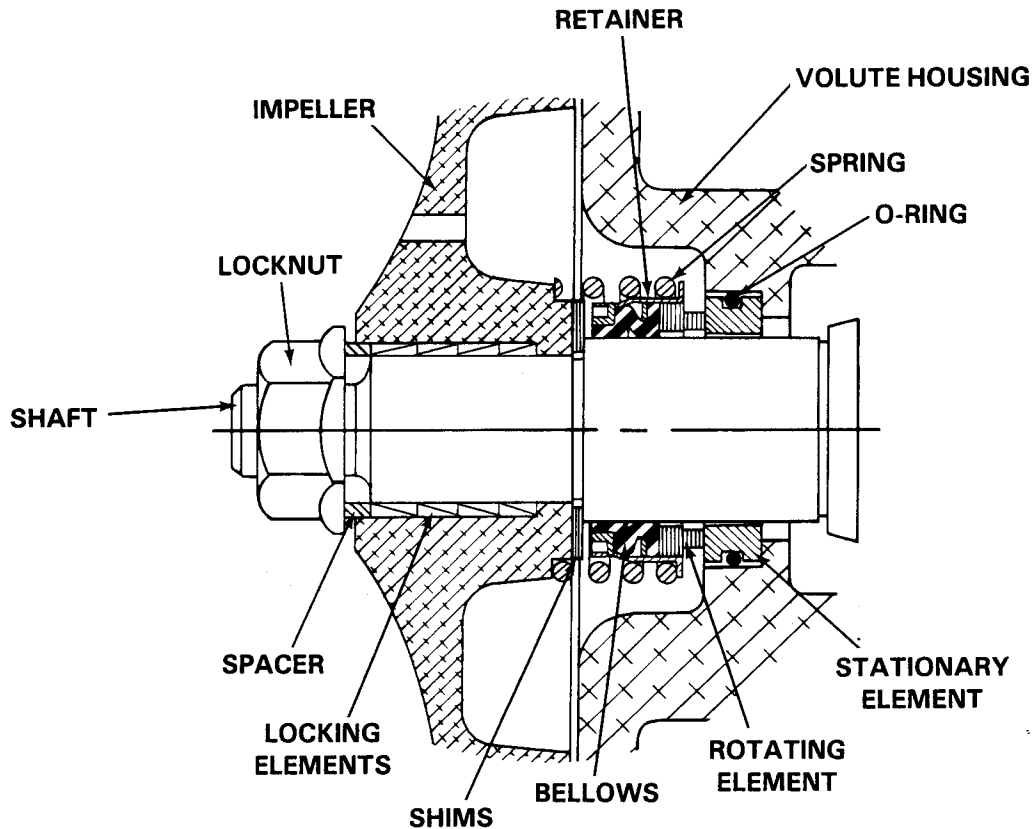

Figure 2. 25271-192 Seal Assembly

Place a drop of light lubricating oil on the lapped faces of the seal, lubricate the stationary seat with soft grease or oil, and install it. Install the stationary and rotating elements. Lubricate the bellows with soft grease or oil, and install the bellows assembly. Install the seal spring, making certain that all components of the seal are seated squarely.

Pump Reassembly

Reinstall the impeller shim set.

Inspect the volute wear ring (46), and replace it if scored or worn. Inspect the impeller, and replace it if cracked or badly worn.

Lightly oil the impeller bore, spacer, and locking elements. Do not use a lubricant containing molybdenum disulfide. Position the impeller on the shaft.

The impeller locking elements must be installed in inner-ring, outer-ring sequence. It is recommended that a special tool (not furnished by Gorman-Rupp) be used when installing the locking elements; see figure 3. This tool can be made from 1 1/4-inch O.D. by 7/8-inch I.D. round mechanical tubing.

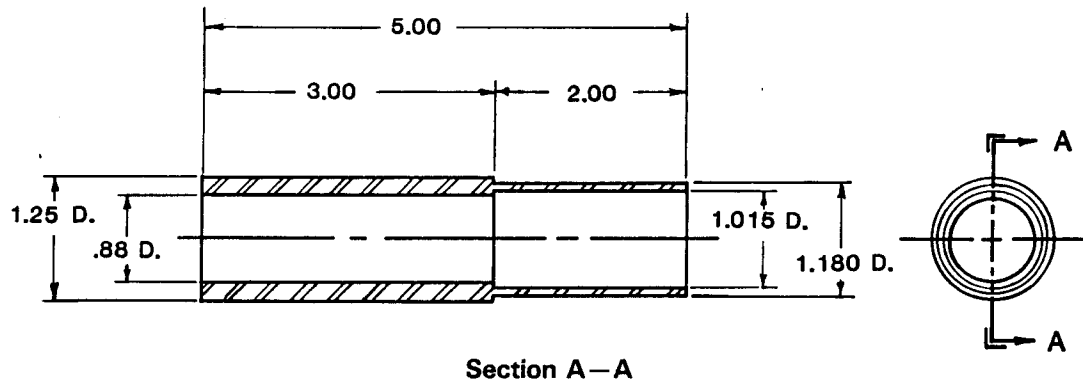

Figure 3. Locking Element Installation Tool

Using the tool, install the first locking element in inner-ring, outer-ring sequence in the bore of the impeller so that it seats squarely against the impeller shoulder. Install the next and subsequent locking elements so that they seat squarely against the previously installed element.

Install the impeller spacer and lock nut, and torque the lock nut to 120 ft. lbs.

Turn the shaft to check that the impeller rotates freely. If the impeller binds, add or remove impeller shims until it rotates freely.

Inspect the suction head wear ring, and replace it if cracked or worn. Replace the suction head gasket (4), and reinstall the suction head.

If the pump is to be put into service at this time, reconnect the suction piping, lubricate the gearbox, and open all connecting valves.



LUBRICATION

Seal Assembly

The seal assembly is lubricated by the medium being pumped.

Gearbox

Remove the gearbox cover pipe plug (20) and gearbox housing pipe plug (34). Add 2 ounces of Molykote M or equivalent gear lubricant and approximately 23 ounces of SAE No. 90 non-detergent motor oil through the cover plug hole. Fill the gearbox until the oil level reaches the housing plug hole. Clean and reinstall both pipe plugs.

Gearbox Disassembly

Refer to **Pump and Seal Disassembly**. Close all connecting valves, and drain the pump and gearbox; clean and reinstall the drain plugs. Disconnect the suction and discharge piping, and remove the pump assembly. Remove the suction head (10), impeller (2), and seal assembly (3).

Disengage the hex nuts (44) securing the gearbox to the volute housing, and separate the assemblies. Remove the oil seal (16) from the volute housing, and the bearing shim set (40); for ease of reassembly, tag and tie the shims.

Disengage the hex head capscrews (19) securing the cover plate assembly (25) to the gearbox housing, and remove the cover plate. Disengage the hex nuts (29) securing the bearing cap (33) to the gearbox housing, and remove the cap.

Extract the drive shaft (31) from the gearbox housing, retaining the drive gear (24) and key (21) as they come free from the shaft. Disengage the drive gear from the pinion shaft (39), and remove the drive shaft bearing (38) seated in the gearbox housing.

Extract the pinion shaft from the gearbox housing, and remove the pinion shaft bearing seated in the housing.

Gearbox Reassembly

Inspect all shafts, gears, and bearings, and replace as necessary.

Reinstall the pinion shaft bearing in the gearbox housing, and reinstall the pinion shaft and bearing.

Reinstall the drive shaft bearing in the gearbox housing. Reinstall the drive gear key, and position the drive gear so that it engages the pinion shaft gear. Install the drive shaft and bearing. Inspect the oil seal (32) and replace as necessary. Reinstall the oil seal in the bearing cap, positioning the lip as shown in figure 1, replace the bearing cap gasket (27), and secure the bearing cap to the gearbox housing.

Replace the cover plate gasket (26), and secure the cover plate to the gearbox housing.

Replace the bearing shims. After final reassembly, shaft end play should fall between .005 to .012 inches; add or remove bearing shims to reach this recommended tolerance. Inspect the oil seal, and replace as necessary. Reinstall the oil seal in the volute housing, positioning the lip as shown in figure 1.

Replace the volute housing O-ring (17) and gasket (18). Secure the gearbox housing assembly to the volute housing. Reinstall the seal assembly, impeller, and suction head (see **Pump and Seal Reassembly**).

Reinstall the pump and gearbox assembly, connect all piping, and lubricate the gearbox (see LUBRICATION).

**For U.S. and International Warranty Information,
Please Visit www.grpumps.com/warranty
or call:
U.S.: 419-755-1280
International: +1-419-755-1352**

**For Canadian Warranty Information,
Please Visit www.grcanada.com/warranty
or call:
519-631-2870**