

INSTALLATION, OPERATION, PARTS LIST,  
AND MAINTENANCE MANUAL

---



C

May 26, 1981

A large, stylized outline of a centrifugal pump housing, which serves as a background for the main title text.

***Basic Self-Priming  
Centrifugal Pump***  
***Model 03A52-B***

THE GORMAN-RUPP COMPANY • MANSFIELD, OHIO

GORMAN-RUPP OF CANADA LIMITED • ST. THOMAS, ONTARIO, CANADA

Printed in U.S.A.

Copyright by the Gorman-Rupp Company





This Installation, Operation, and Maintenance Manual is designed to help you get the best performance and longest life from your Gorman-Rupp pump.

This pump is an O Series, enclosed impeller, self-priming centrifugal model with straight-in suction without a suction check valve, and is suitable for pumping liquids which do not contain large solids. For specific service, consult your Gorman-Rupp distributor or the Gorman-Rupp Company.

If there are any questions regarding the pump which are not covered in this manual or in other literature accompanying the unit, please contact your Gorman-Rupp distributor, or write:

The Gorman-Rupp Company	or	Gorman-Rupp of Canada Limited
P.O. Box 1217		70 Burwell Road
Mansfield, Ohio 44902		St. Thomas, Ontario N5P 3R7

For information or technical assistance on the power source, contact the power source manufacturer's local dealer or representative.

The following are used to alert maintenance personnel to procedures which require special attention, to those which could damage equipment, and to those which could be dangerous to personnel:

**NOTE**

Instructions to aid in installation, operation, or maintenance or which clarify a procedure.

**CAUTION**

Instructions which must be followed to avoid causing damage to the product or other equipment incidental to the installation. These describe the procedure required and the damage which could result from failure to follow the procedure.

**WARNING**

Instructions which must be followed to avoid causing injury or death to personnel. These describe the procedure required and the injury which could result from failure to follow the procedure.

**TABLE OF CONTENTS**

WARNINGS	Section A
INSTALLATION	Section B
OPERATION	Section C
TROUBLESHOOTING	Section D
MAINTENANCE AND REPAIR	Section E
WARRANTY	



## WARNINGS

**THESE WARNINGS APPLY TO O SERIES BASIC PUMPS. GORMAN-RUPP HAS NO CONTROL OVER OR PARTICULAR KNOWLEDGE OF THE POWER SOURCE WHICH WILL BE USED. REFER TO THE MANUAL ACCOMPANYING THE POWER SOURCE BEFORE ATTEMPTING TO START THE POWER SOURCE.**

Before attempting to open or service the pump:

1. Familiarize yourself with this manual.
2. Disconnect the power source to ensure that the pump will remain inoperative.
3. Allow the pump to cool if overheated.
4. Vent the pump slowly and cautiously.
5. Close the suction and discharge valves.
6. Check the temperature before opening any covers, plates, or plugs.
7. Drain the pump.

This pump is designed primarily to handle specific volatile and/or flammable liquids. Do not attempt to pump any liquids for which this pump has not been designed.

This pump is usually installed in a permanent configuration. After the pump has been installed, make certain that the pump and all piping connections are secure before attempting to operate it.

Do not operate the pump without shields and/or guards in place over drive shafts, belts and/or couplings, or other rotating parts. Exposed rotating parts can catch clothing, fingers, or tools, causing severe injury to personnel.

Do not operate the pump against a closed discharge valve for long periods of time. This could bring the liquid to a boil, build pressure, and cause the pump to rupture or explode.



Overheated pumps can cause severe burns and injury. If overheating of the pump casing occurs:

1. Stop the pump immediately.
2. Allow the pump to cool.
3. Refer to instructions in this manual before restarting the pump.

Do not remove plates, covers, gauges, pipe plugs, or fittings from an overheated pump. Vapor pressure within the pump can cause parts being disengaged to be ejected with great force. Allow the pump to cool before servicing.

If this pump is used with volatile and/or flammable liquids, overheating may produce dangerous fumes. Use extreme caution when venting the pump, or when removing covers, plates, plugs or fittings.

If this pump is used with volatile and/or flammable liquids, take precautions to ensure that adequate ventilation is provided, and that adequate protective clothing is worn, while the pump is being serviced.

## INSTALLATION

Since pump installations vary, this section is intended only to summarize recommended installation practice. If there are any questions concerning a specific installation, contact your Gorman-Rupp distributor or the Gorman-Rupp Company.

### PREINSTALLATION INSPECTION

The pump assembly was inspected and tested before it was shipped from the factory. Before installation, inspect the pump for damage which may have occurred during shipment.

a. Check the pump assembly for cracks, dents, damaged threads, and other obvious damage.

b. Check for and tighten loose bolts, nuts, cap screws, and other attaching hardware. Since gaskets tend to shrink after drying, check for and tighten loose nuts and cap screws securing mating surfaces.

c. Carefully read all tags, decals, and markings on the pump assembly, and perform all duties indicated. Note the direction of rotation indicated on the pump. Check that the pump shaft rotates in the required direction.

#### CAUTION

Only operate this pump in the direction indicated by the arrow on the pump body and on the accompanying decal. Otherwise, the impeller could become loosened from the shaft and seriously damage the pump.

d. Check all lubricant levels and lubricate as necessary. Refer to the MAINTENANCE AND REPAIR section of this manual.

### POSITIONING THE PUMP

#### Mounting

Locate the pump in an accessible place as close as practical to the liquid being pumped. Level mounting is essential for proper operation. It may be necessary to support or shim the pump for level operation.

### Lifting

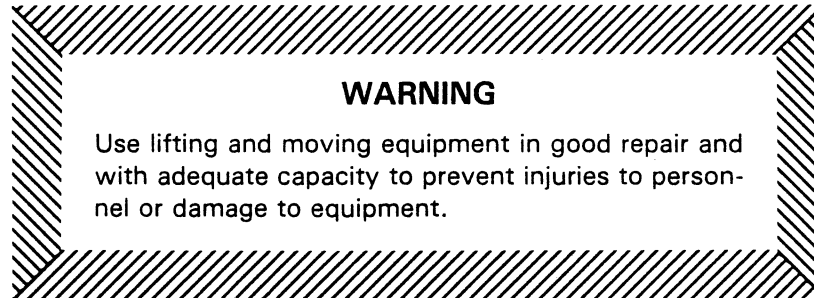

Make sure that hoists and other lifting equipment are of sufficient capacity to safely handle the pumping assembly. If chains and cables are used in lifting, make certain that they are positioned so that they will not damage the pump, and so that the load will be balanced.

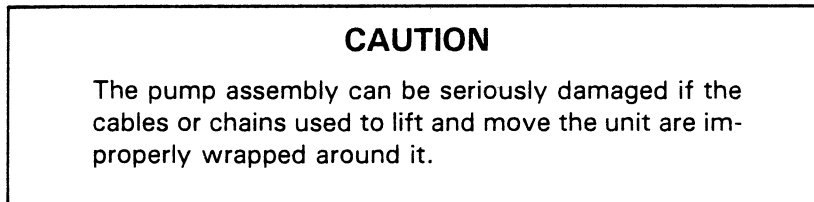

## SUCTION AND DISCHARGE PIPING

### Materials

This pump is usually installed in a permanent piping configuration, but either pipe or hose may be used for suction and discharge lines. Piping materials must be compatible with the liquid being pumped. If hose is used in suction lines, it must be the rigid-wall, reinforced type to prevent collapse under suction. Using pipe couplings in suction lines is not recommended.

### Line Configuration

Keep suction and discharge lines as straight as possible to minimize friction losses. Make minimum use of elbows and fittings, which substantially increase friction loss. If elbows are necessary, use the long-radius type to minimize friction loss.

### Connections to Pump

Before tightening a connecting flange, align it exactly with the pump port. Never pull a pipe line into place by tightening the flange bolts.

Lines near the pump must be independently supported to avoid strain on the pump which could cause excessive vibration, decreased bearing life, and increased shaft and seal wear. If hose-type lines are used, they should have adequate support to secure them when filled with liquid and under pressure.

### Gauges

Most pumps are drilled and tapped for installing discharge pressure and vacuum suction gauges. If these gauges are desired for pumps that are not tapped, drill and tap the suction and discharge lines close to the pump before installing the lines.



## SUCTION LINES

To avoid air pockets which could affect pump priming, the suction line must be as short and direct as possible. When operation involves a suction lift, the line must always slope upward to the pump from the source of the liquid being pumped; if the line slopes down to the pump at any point along the suction run, air pockets will be created.

### Fittings

Suction lines should be the same size as the pump inlet. If reducers are used in suction lines, they should be the eccentric type, and should be installed with the flat part of the reducers uppermost to avoid creating air pockets. Valves are not normally used in suction lines, but if a valve is used, install it with the stem down or to either side to avoid air pockets.

### Strainers

This pump is designed primarily for liquids which do not need straining, and a strainer is not usually furnished with the pump when it is shipped from the factory. If a strainer is furnished with the pump, however, be certain to use it. Any entrained solids which pass through a strainer furnished with the pump will also pass through the pump itself.

If a strainer is not furnished with the pump, but is installed by the pump user, make certain that the total area of the openings in the strainer is at least three or four times the cross section of the suction line, and that the openings will not permit passage of solids larger than the solids handling capability of the pump.

### Sealing

Since even a slight leak will affect priming, head, and capacity, especially when operating with a high suction lift, all connections in the suction line should be sealed with pipe dope to ensure an airtight seal. In volatile and/or corrosive service, the pipe dope should be compatible with the liquid being pumped.

### Suction Lines In Sumps

If a single suction line is installed in a sump, it should be positioned away from the wall of the sump at a distance equal to one and one-half the size of the suction line.

If there is a liquid flow from an open pipe into the sump, the flow should be kept away from the suction inlet because the inflow will carry air down into the sump, and air entering the suction line will reduce pump efficiency.

If it is necessary to position inflow close to the suction inlet, install a baffle between the inflow and the suction inlet at a distance one and one-half times the size of the suction line. The baffle will allow entrained air to escape from the liquid before it is drawn into the suction inlet.

If two suction lines are installed in a single sump, the flow paths may interact, reducing the efficiency of one or both pumps. To avoid this, position the suction inlets so that they are separated by a distance at least three times the diameter of the suction line.

**Suction Line Positioning**

The depth of submergence of the suction line is critical to efficient pump operation. Figure 1 shows recommended minimum submergence vs. velocity.

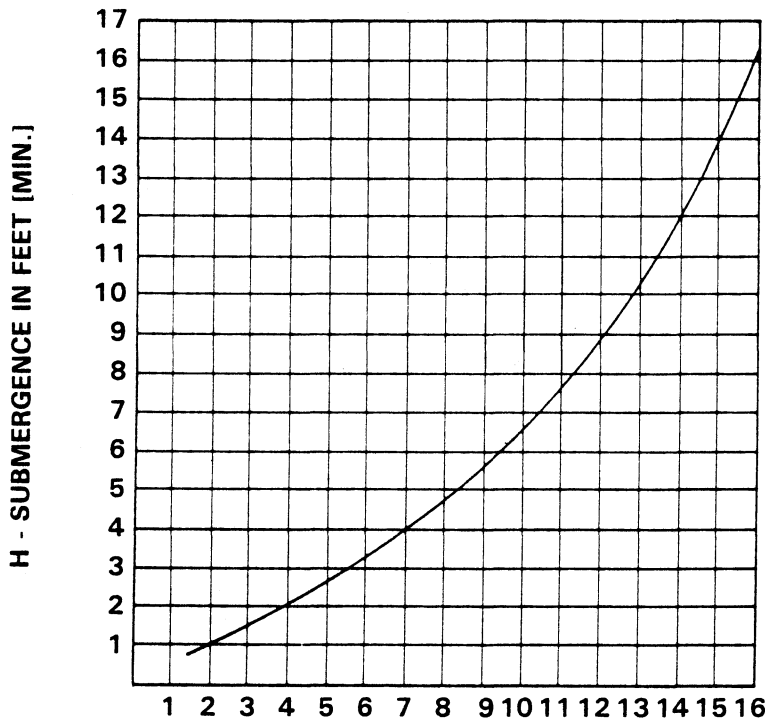

$$\text{VELOCITY IN FEET PER SEC.} = \frac{\text{QUAN. [G.P.M.] x .321}}{\text{AREA}} \text{ OR } \frac{\text{G.P.M. x .4085}}{D^2}$$

Figure 1. Recommended Minimum Suction Line Submergence Vs. Velocity

**DISCHARGE LINES**

Do not terminate the discharge line at a level lower than that of the liquid being pumped unless a siphon breaker is used in the line. Otherwise, a siphoning action causing damage to the pump could result.

**Valves**

If a throttling valve is desired in the discharge line, use a valve as large as the largest pipe in the line to minimize friction losses. Never install a throttling valve in a suction line.

A check valve in the discharge line is normally recommended, but is not necessary in low discharge head applications.

It is recommended that a throttling valve and a check valve be installed in the discharge line to protect the pump from excessive shock pressure and reverse rotation when it is stopped.

**Bypass Lines**

If it is necessary to permit the escape of air to atmosphere in initial priming or during the repriming cycle, install a bypass line — sized so that it will not affect pump discharge capacity — between the pump and the discharge check valve. Since this pump does not use a suction check valve, the discharge end of the bypass line must be submerged in the liquid being pumped in order to maintain suction.

**NOTE**

The bypass line may clog frequently, particularly if the valve remains closed. If this condition occurs, either use a larger bypass line or leave the shutoff valve open during the pumping operation.

**ALIGNMENT**

Aligning the pump and its power source is critical for trouble-free mechanical operation.

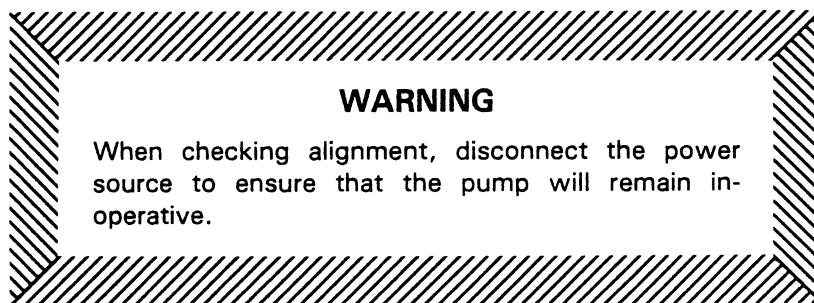

Before checking alignment, tighten the foundation bolts, pump casing and/or pedestal feet, and power source mounting bolts. Make sure that the pump is level.

**CAUTION**

Adjusting the alignment in one direction may alter the alignment in another direction. Check each procedure after altering alignment.

### Coupling-Driven Pumps

When using couplings, the axis of the power source must be aligned to the axis of the pump shaft in both the horizontal and vertical planes. Most couplings require a specific gap or clearance between the driving and the driven shafts. Refer to the coupling manufacturer's service literature.

Align spider insert type couplings by using calipers to measure the dimensions on the circumference of the outer ends of the coupling hub every 90 degrees. The coupling is in alignment when the hub ends are the same distance apart at all points (see figure 2A).

Align non-spider type couplings by using a feeler gauge or taper gauge between the coupling halves every 90 degrees. The coupling is in alignment when the hubs are the same distance apart at all points (see figure 2B).

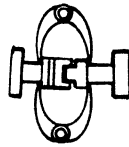

Figure 2A. Aligning Spider-Type Couplings



Figure 2B. Aligning Non-Spider Type Couplings

Check parallel adjustment by laying a straightedge across both coupling rims at the top, bottom, and side. When the straightedge rests evenly on both halves of the coupling, the coupling is in horizontal parallel alignment. If the coupling is misaligned, use a feeler gauge between the coupling and the straightedge to measure the amount of misalignment.

### V-Belt Driven Pumps

When using V-belt drives, the power source and the pump must be parallel. Use a straightedge along the sides of the pulleys to ensure that the pulleys are properly aligned (see figure 2C). In drive systems using two or more belts, make certain that the belts are a matched set; unmatched sets will cause accelerated belt wear.



**MISALIGNED: SHAFTS NOT  
PARALLEL**

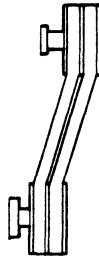

**MISALIGNED: SHEAVES NOT  
IN LINE**



**ALIGNED: SHAFTS PARALLEL  
AND SHEAVES IN LINE**

**Figure 2C. Alignment of V-Belt Driven Pumps**

Tighten the belts in accordance with the belt manufacturer's instructions. If the belts are too loose, they will slip; if the belts are too tight, there will be excessive power loss and possible bearing failure. Select pulleys that will match the proper speed ratio; overspeeding the pump may damage both pump and power source.

#### **Drive Shaft Guards**

Driver and shaft assemblies, couplings, and belts and sheaves mounted at the Gorman-Rupp factory are supplied with a guard for protection of personnel. Do not operate the pump without a guard.

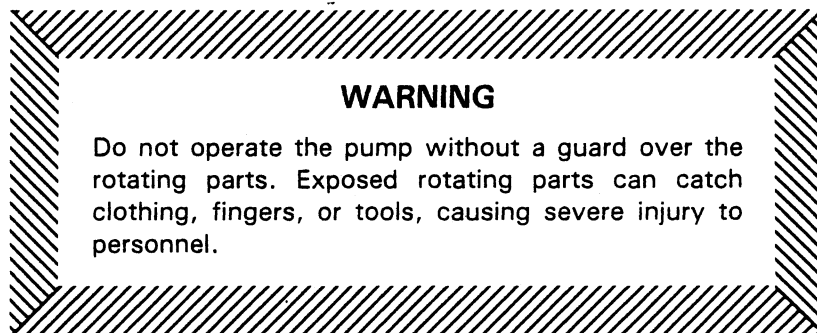



## OPERATION

### WARNING

This pump is designed primarily to handle specific volatile and/or flammable liquids. Do not attempt to pump any volatile and/or flammable liquids for which this pump has not been designed.

### PRIMING

Install the pump and piping as described in INSTALLATION. Make sure that the piping connections are tight, and that the pump is securely mounted. Check that the pump is properly lubricated (see LUBRICATION in MAINTENANCE AND REPAIR).

Although this pump is self-priming, it should never be operated unless the volute is filled with liquid.

### CAUTION

Never operate this pump unless the volute is filled with liquid. The pump will not prime when dry. Extended operation of a dry pump will destroy the seal assembly.

### Fill the pump with liquid:

1. When the pump is being put into service for the first time.
2. When the pump has not been used for a considerable length of time.
3. When the liquid in the volute housing has evaporated.

When the volute housing is full, the pump will prime and reprime as necessary.

To fill the pump, remove the fill plug at the top of the volute housing, and add clean liquid. Be certain to reinstall the fill plug before operating the pump.

### WARNING

After filling the volute housing, do not attempt to operate the pump unless the fill plug and all connecting piping is securely installed. Otherwise, liquid in the pump forced out under pressure could cause injury to personnel.

**STARTING****Rotation**

The correct direction of pump rotation is indicated by an arrow on the pump body, and on the accompanying decal. If the pump is operated in the wrong direction, the impeller could become loosened from the shaft and seriously damage the pump.

**CAUTION**

Only operate this pump in the direction indicated by the arrow on the pump body and on the accompanying decal. Otherwise, the impeller could become loosened from the shaft and seriously damage the pump.

Consult the operating manual furnished with the power source before attempting to start the power source.

If a three-phase electric motor is being used, check rotation by starting the pump for a moment to see if the rotation is correct. If the shaft, coupling, or V-belt is not visible, rotation can usually be determined by observing the motor cooling fan. If the rotation is incorrect, have qualified personnel interchange any two of the three-phase wires to change direction.

**Lines With a Bypass**

Since this pump does not have a suction check valve, the discharge end of the bypass line must be submerged in order to maintain suction.

Close the throttling valve in the discharge line, and open the shutoff valve in the bypass line so that the pump will not have to prime against the weight of the liquid in the discharge line. Start the power source. When the pump has been primed and liquid is flowing steadily through the bypass line, close the bypass shutoff valve and open the discharge throttling valve.

**Lines Without a Bypass**

Open all valves in the discharge line and start the power source. Priming is indicated by a positive reading on the discharge pressure gauge or by quieter operation. The pump may not prime immediately because the suction line must first fill with liquid. If the pump fails to prime within five minutes, stop it and check the suction line for leaks.

After the pump has been primed, partially close the discharge line throttling valve in order to fill the line slowly and guard against excessive shock pressure which could damage pipe ends, gaskets, sprinkler heads, and any other fixtures connected to the line. When the discharge line is completely filled, adjust the throttling valve to the required discharge flow rate.

**Leakage**

No leakage should be visible at pump mating surfaces, or at pump connections or fittings. Keep all line connections and fittings tight to maintain maximum pump efficiency.



### Overheating

Overheating can occur if the valves in the suction or discharge lines are closed. Operating against closed valves could bring the liquid to a boil, build pressure, and cause the pump to rupture or explode. If overheating occurs, stop the pump and allow it to cool before servicing it. Refill the volute casing with cool liquid.

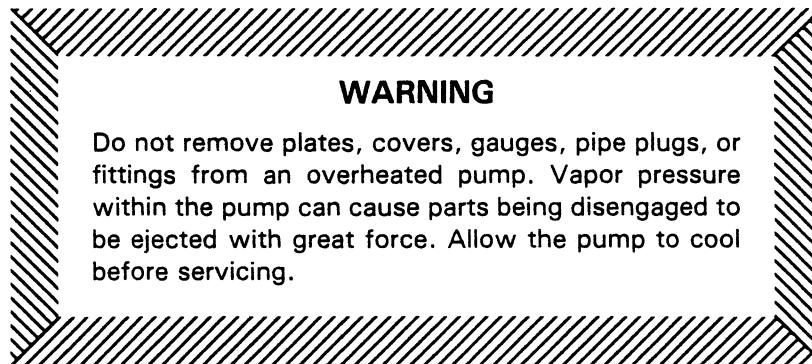

### Strainer Check

If a suction strainer has been shipped with the pump or installed by the user, check the strainer regularly, and clean it as necessary. The strainer should also be checked if pump flow rate begins to drop.

### Pump Vacuum Check

Since this pump does not have a suction check valve, the discharge line must be fitted with a check valve if a pump vacuum reading is to be taken.

With the pump inoperative, install a vacuum gauge in the system, using pipe dope on the threads. Block the suction line and start the pump. At operating speed the pump should pull a vacuum of 20 inches or more of mercury. If it does not, check for air leaks in the seal or gasket.

Open the suction line, and read the vacuum gauge with the pump primed and at operating speed. Shut off the pump, and read the gauge again to determine if the vacuum remains at the maximum developed by the pump. If the vacuum falls off rapidly, an air leak exists; check to make certain that the air leak is not from the vacuum gauge connection.

### Stopping

After stopping the pump, disconnect the power source to ensure that the pump will remain inoperative.

Unless they are extremely severe, below-freezing conditions will not affect pump operation in petroleum service. In other service in below-freezing conditions, a stopped pump should be drained, and any solids cleaned out by flushing with a hose, to prevent damage from freezing. After draining and flushing, operate the pump for approximately one minute to remove any remaining liquid that could freeze pump rotating parts.

In above-freezing conditions, a pump which will be idle for more than a few hours, or which has been pumping liquids containing solids, should be drained and flushed thoroughly. Operate the pump during the draining process.

### **BEARING TEMPERATURE CHECK**

Bearings normally run at higher than ambient temperatures because of heat generated by friction. Temperatures up to 160°F are considered normal for pedestal bearings, and they can operate safely to at least 180°F.

Checking bearing temperatures by hand is inaccurate. Bearing temperatures can be measured accurately by placing a contact-type thermometer against the housing. Record this temperature for future reference.

A sudden increase in bearing temperatures is a warning that the bearings are at the point of failing to operate properly. Make certain that the bearing lubricant is of the proper viscosity and at the correct level (see LUBRICATION in MAINTENANCE AND REPAIR). Bearing overheating can also be caused by shaft misalignment and/or excessive vibration.

When pumps are first started, the bearings may seem to run at temperatures above normal. Continued operation should bring the temperatures down to normal levels.



## TROUBLESHOOTING

### WARNING

Before attempting to open or service the pump:

1. Consult pump service manual.
2. Disconnect the power source to ensure that the pump will remain inoperative.
3. Allow pump to cool if overheated.
4. Close suction and discharge valves.
5. Drain pump.

Trouble	Possible Cause	Probable Remedy
<b>PUMP FAILS TO PRIME</b>	Air leak in suction line.  Lining of suction hose collapsed.  Leaking or worn seal or pump gasket.  Suction lift or discharge head too high.  Strainer clogged.	Correct leak.  Replace suction hose.  Check pump vacuum. Replace leaking or worn seal or gasket.  Check piping installation and install bypass line if needed. See <b>INSTALLATION</b> .  Check strainer and clean if necessary.
<b>PUMP STOPS OR FAILS TO DELIVER RATED FLOW OR PRESSURE</b>	Air leak in suction line.  Suction intake not submerged at proper level or sump too small.  Lining of suction hose collapsed.  Impeller or other wearing parts worn or damaged.  Impeller clogged.  Pump speed too slow.  Discharge head too high.  Suction lift too high.  Strainer clogged.	Correct leak.  Check installation and correct as needed. Check submergence chart (Section B, 4).  Replace suction hose.  Replace worn or damaged parts. Check that impeller is properly centered and rotates freely.  Free impeller of debris.  Check driver output; check belts or couplings for slippage.  Install bypass line.  Reduce suction lift.  Check strainer and clean if necessary.

Trouble	Possible Cause	Probable Remedy
PUMP STOPS OR FAILS TO DELIVER RATED FLOW OR PRESSURE (cont)	Leaking or worn seal or pump gaskets.	Check pump vacuum. Replace leaking or worn seal or pump gaskets.
PUMP REQUIRES TOO MUCH POWER	<p>Pump speed too high.</p> <p>Discharge head too low.</p> <p>Liquid solution too thick.</p>	<p>Check driver output; check that sheaves or couplings are correctly sized.</p> <p>Adjust discharge valve.</p> <p>Dilute if possible.</p>
PUMP CLOGS FREQUENTLY	Discharge flow too slow.	Open discharge valve fully to increase flow rate, and run engine at maximum governed speed.
EXCESSIVE NOISE	<p>Cavitation in pump.</p> <p>Pumping entrained air.</p> <p>Pump or drive not securely mounted.</p> <p>Impeller clogged or damaged.</p>	<p>Reduce suction lift and/or friction losses in suction line.</p> <p>Locate and eliminate source of air bubble.</p> <p>Secure mounting hardware.</p> <p>Clean out debris; replace damaged parts.</p>
BEARINGS RUN TOO HOT	<p>Bearing temperature is high, but within limits.</p> <p>Low or incorrect lubricant.</p> <p>Suction and discharge lines not properly supported.</p> <p>Drive misaligned.</p>	<p>Check bearing temperature frequently to monitor any increase.</p> <p>Check for proper type and level of lubricant.</p> <p>Check piping installation for proper support.</p> <p>Align drive properly.</p>

# ***Basic Self-Priming Centrifugal Pump Model 03A52-B***

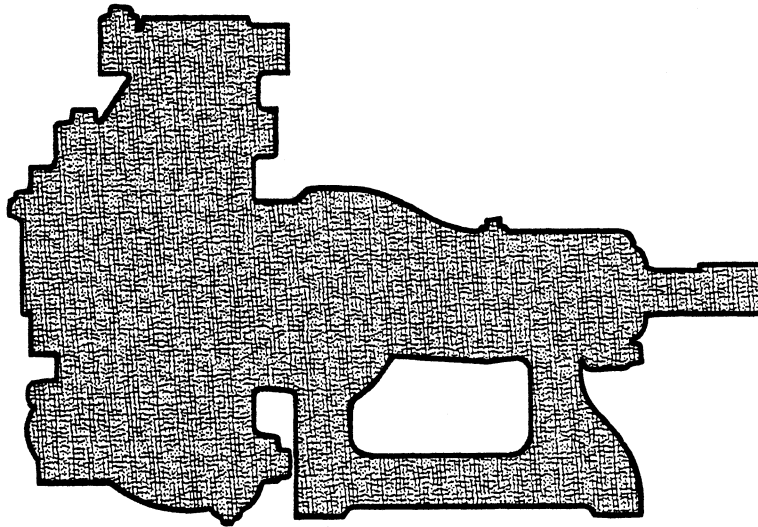

The only moving parts of this pump are the impeller, seal rotating elements, and the shaft. The wear ring, impeller, and seal, which receive the most wear, are easily accessible and can be replaced without disturbing the piping. Maintenance and replacement of these parts will maintain the peak operating efficiency of the pump.

# SECTIONAL DRAWING

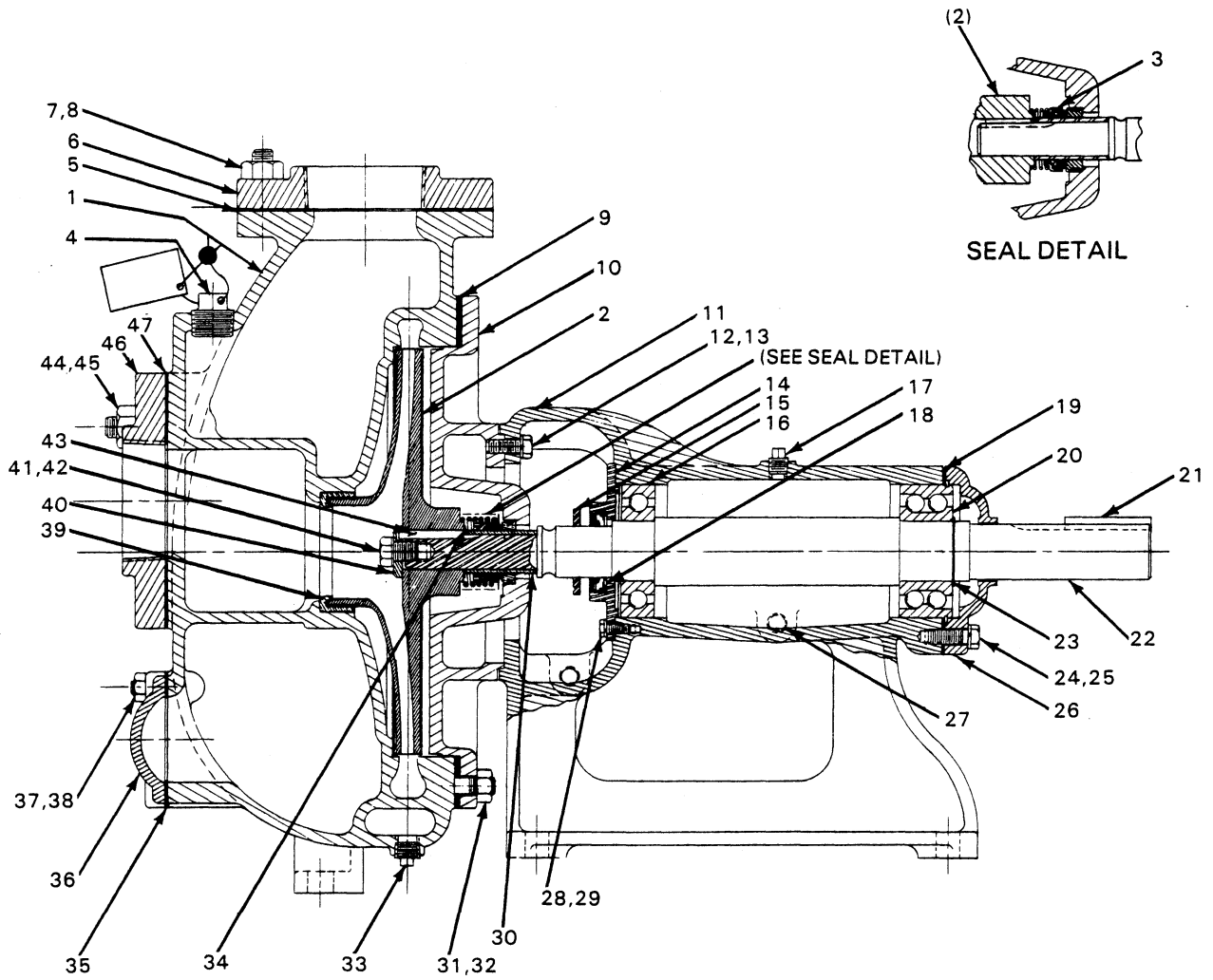

Figure 1. Pump Model O3A52-B



# PARTS LIST

## PUMP MODEL 03A52-B

(From S/N 251067 up)

ITEM NO.	PART NAME	PART NUMBER	MATL CODE	QTY	ITEM NO.	PART NAME	PART NUMBER	MATL CODE	QTY			
1	VOLUTE HOUSING	4156-A	10010	1	25	LOCKWASHER	J-06	15991	4			
2	★ IMPELLER	4170-D	10010	1	26	BEARING CAP	64-H7	10010	1			
3	★ SEAL ASSEMBLY	25284-951	-	1	27	PEDESTAL DRAIN PLUG	P-04	11990	1			
4	FILL PLUG ASSEMBLY	48271-062	-	1	28	HEX HEAD CAPSCREW	B-0403	15991	4			
5	★ DISCHARGE FLNG GSKT	1674-GB	20000	1	29	LOCKWASHER	J-04	15991	4			
6	DISCHARGE FLANGE	1753-A	10010	1	30	SHAFT SLEEVE	2146-F	17030	1			
7	STUD	C-1009	15991	4	31	STUD	C-0807	15991	12			
8	HEX NUT	D-10	15991	4	32	HEX NUT	D-08	15991	12			
9	★ VOLUTE HOUSING GSKT	4156-GA	20000	1	33	VOLUTE DRAIN PLUG	P-04	11990	1			
10	SEAL PLATE	5349-A	10010	1	34	★ IMPELLER SHIM SET	2-X	17090	1			
11	PEDESTAL	7639	10010	1	35	★ COVER GASKET	4635-GA	20000	1			
12	HEX HEAD CAPSCREW	B-0604	15991	4	36	COVER	4635	10010	1			
13	LOCKWASHER	J-06	15991	4	37	STUD	C-0606	15991	4			
14	BEARING CAP	7622	10010	1	38	HEX NUT	D-06	15991	4			
15	★ SLINGER RING	2352	19120	1	39	★ WEAR RING	4158-A	10010	1			
16	★ BALL BEARING	S-0374	-	1	40	IMPELLER WASHER	6750-A	17000	1			
17	PEDESTAL VENTED PLUG	4823	11990	1	41	IMPELLER CAPSCREW	B-0803-S	15991	1			
18	★ GREASE SEAL	S-29	-	1	42	IMPELLER LOCKWASHER	AK-08	15991	1			
19	★ BEARING CAP SHIM SET	3876-A	15990	1	43	IMPELLER KEY	N-0407½	15990	1			
20	★ BALL BEARING	S-0375	-	1	44	STUD	C-1009	15991	4			
21	SHAFT KEY	N-0610	15990	1	45	HEX NUT	D-10	15991	4			
22	★ IMPELLER SHAFT	5343-A	15010	1	46	SUCTION FLANGE	1753-A	10010	1			
23	RETAINING RING	S-0442	-	1	47	★ SUCTION FLANGE GSKT	1674-GB	20000	1			
24	HEX HEAD CAPSCREW	B-0605	15991	4	NOT SHOWN:							
★ INDICATES PARTS RECOMMENDED FOR STOCK					NAME PLATE					2613-C	13990	1
Above Serial Numbers Do Not Apply To Pumps Made In Canada.					ROTATION DECAL					2613-CU	00000	1

CANADIAN SERIAL NO. . . . . AND UP

## PUMP AND SEAL DISASSEMBLY AND REASSEMBLY

This pump requires little service due to its rugged, minimum-maintenance design. If it becomes necessary to inspect or replace components in and adjacent to the rotating assembly, however, follow these instructions, which are keyed to the sectional view (see figure 1) and the accompanying parts list.

### Pump Disassembly

#### WARNING

Before attempting to open or service the pump:

1. Familiarize yourself with this manual.
2. Disconnect the power source to ensure that the pump will remain inoperative.
3. Allow the pump to cool if overheated.
4. Vent the pump slowly and cautiously.
5. Close the suction and discharge valves.
6. Check the temperature before opening any covers, plates, or plugs.
7. Drain the pump.

Disconnect the power source, making certain that it will remain inoperative while the pump is being serviced, and close all connecting valves.

Remove the volute housing drain plug (33) to drain the pump. Clean and reinstall the plug after the pump has been drained.

For access to the impeller (2) and seal assembly (3), the pump must be opened at the point where the volute housing (1) and seal plate (10) are joined. Remove the hex nuts (32) securing the volute housing to the seal plate, and separate the assemblies.

To remove the impeller, immobilize it by placing a block of wood between the vanes, and disengage the impeller capscrew (41), washers (40 and 42). Slide the impeller off the shaft (22) retaining shaft key (43). Use caution when sliding the impeller from the shaft; tension on the seal spring will be released as the impeller is removed.

Remove the impeller adjusting shims (34). For ease of reassembly, tag and tie the shims, or measure and record their thickness.



**Seal Disassembly**

Remove the seal spring. Using a stiff wire with a hooked end if necessary, remove the remainder of the seal components and the shaft sleeve (30).

Clean the seal cavity and the shaft with a soft cloth soaked in cleaning solvent.

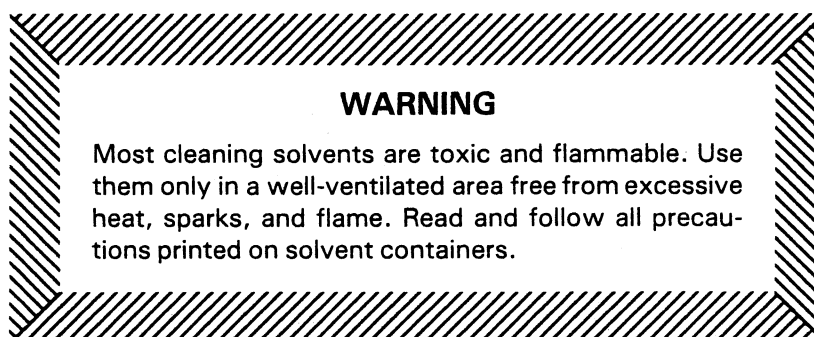
**Seal Reassembly**

The seal is not normally reused because of the high polish on its lapped face, but if it is necessary to reuse the old seal, wash all metallic parts in cleaning solvent and dry thoroughly.

Inspect the seal components for wear, scoring, grooves, and other damage that might cause leakage. If any components are worn, replace the complete seal; never mix old and new seal parts.

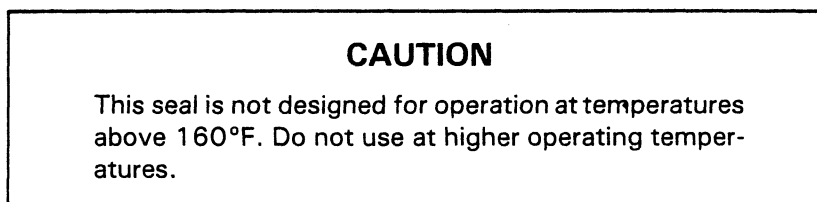

See figure 2 for the correct order of installation of seal components.

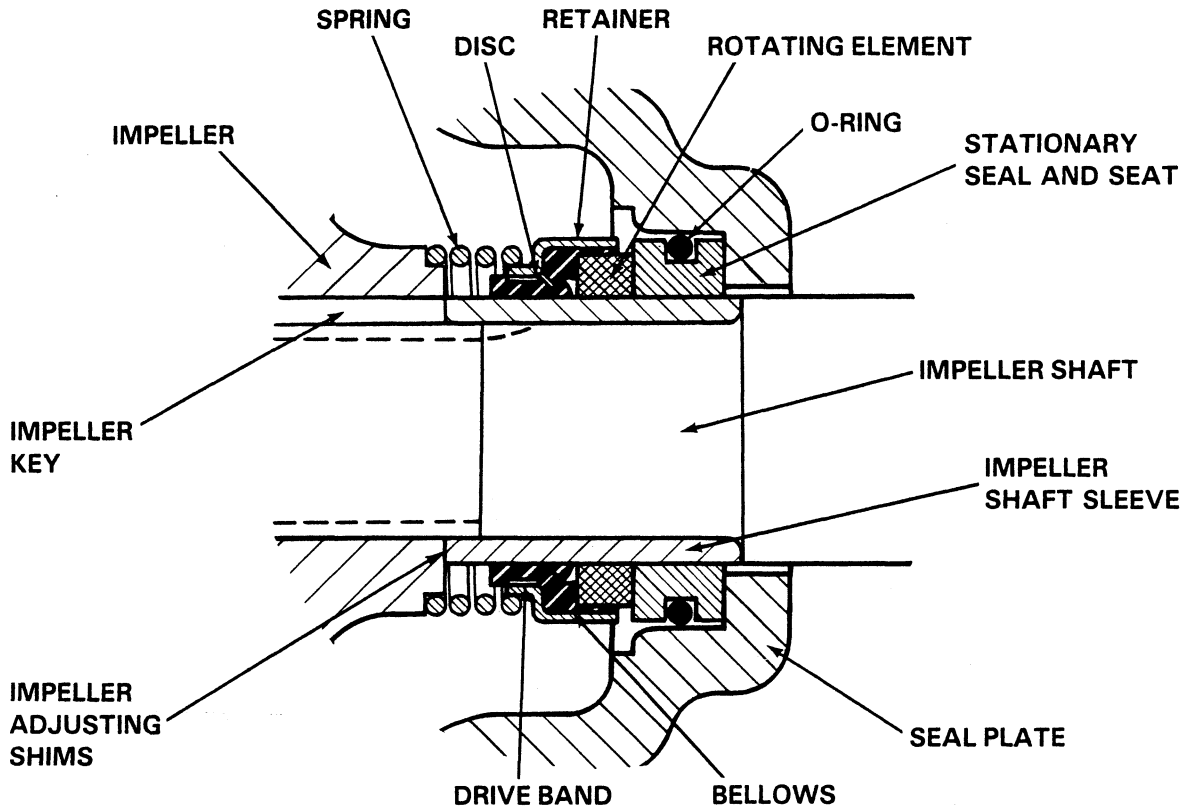

Figure 2. 25284-951 Seal Assembly

Clean and polish the shaft sleeve, or replace it if there are nicks or cuts on the end; reinstall the shaft sleeve.

Place a drop of light lubricating oil on the lapped faces of the seal. Lubricate the stationary seat O-ring with soft grease or oil; install the O-ring in the stationary seat.

Install the stationary seat, and rotating element. Lubricate the bellows with soft grease or oil, and install the bellows assembly. Install the seal spring, making certain that all components of the seal are seated squarely.

#### Pump Reassembly

For maximum pump efficiency, the impeller must be centered with the volute scroll.

Install the impeller adjusting shims. If the same number and thickness of impeller shims are reinstalled as were removed, the impeller should be centered with the volute scroll.

Inspect the wear ring (39), and replace if badly worn.



Inspect the impeller, and replace it if cracked or badly worn. Install the impeller shaft key, and slide the impeller onto the shaft. Install the impeller washers, and install and tighten the impeller capscrew.

Replace the volute housing gasket (9) and secure the volute housing to the seal plate.

Turn the shaft by hand to check that the impeller rotates freely. If it does not, remove additional impeller shims until the impeller rotates freely when the pump is completely assembled.

Remove the fill plug (4), and fill the volute with clean liquid. Clean and reinstall the fill plug. Make certain that the fill plug and all piping are securely tightened before starting the pump.

## LUBRICATION

### Seal Assembly

The seal assembly is lubricated by the medium being pumped.

### Bearings

When shipped from the factory, this pump contained sufficient grease to lubricate the bearings for approximately 5,000 operating hours. Do not lubricate sooner than required. When additional grease is required, remove the vented pedestal plug (17), and fill the cavity with No. 0 pressure gun grease until the cavity is approximately one-third full, or just below the shaft. Clean and reinstall the vented pedestal plug.





**For U.S. and International Warranty Information,  
Please Visit [www.grpumps.com/warranty](http://www.grpumps.com/warranty)  
or call:  
U.S.: 419-755-1280  
International: +1-419-755-1352**

**For Canadian Warranty Information,  
Please Visit [www.grcanada.com/warranty](http://www.grcanada.com/warranty)  
or call:  
519-631-2870**