**INSTALLATION, OPERATION,
AND MAINTENANCE MANUAL**
WITH PARTS LIST



80 SERIES PUMPS

MODEL
82K3-(8) PPO

THE GORMAN-RUPP COMPANY • MANSFIELD, OHIO

www.grpumps.com

GORMAN-RUPP OF CANADA LIMITED • ST. THOMAS, ONTARIO, CANADA Printed in U.S.A.

©1986 The Gorman-Rupp Company

Register your new
Gorman-Rupp pump online at
www.grpumps.com

Valid serial number and e-mail address required.



The engine exhaust from this product contains chemicals known to the State of California to cause cancer, birth defects or other reproductive harm.

RECORD YOUR PUMP MODEL AND SERIAL NUMBER

Please record your pump model and serial number in the spaces provided below. Your Gorman-Rupp distributor needs this information when you require parts or service.

Pump Model: _____

Serial Number: _____

TABLE OF CONTENTS

INTRODUCTION	PAGE I – 1
SAFETY - SECTION A	PAGE A – 1
INSTALLATION – SECTION B	PAGE B – 1
POSITIONING PUMP	PAGE B – 1
Lifting	PAGE B – 1
Mounting	PAGE B – 1
SUCTION AND DISCHARGE PIPING	PAGE B – 2
Materials	PAGE B – 2
Line Configuration	PAGE B – 2
Connections to Pump	PAGE B – 2
Gauges	PAGE B – 2
SUCTION LINES	PAGE B – 2
Fittings	PAGE B – 2
Strainers	PAGE B – 2
Sealing	PAGE B – 2
Suction Lines In Sumps	PAGE B – 3
Suction Line Positioning	PAGE B – 3
DISCHARGE LINES	PAGE B – 4
Siphoning	PAGE B – 4
Valves	PAGE B – 4
Bypass Lines	PAGE B – 4
OPERATION – SECTION C	PAGE C – 1
PRIMING	PAGE C – 1
STARTING	PAGE C – 1
OPERATION	PAGE C – 1
Lines With a Bypass	PAGE C – 1
Lines Without a Bypass	PAGE C – 2
Leakage	PAGE C – 2
Liquid Temperature And Overheating	PAGE C – 2
Strainer Check	PAGE C – 2
Pump Vacuum Check	PAGE C – 2
STOPPING	PAGE C – 2
Cold Weather Preservation	PAGE C – 3
TROUBLESHOOTING – SECTION D	PAGE D – 1
PREVENTIVE MAINTENANCE	PAGE D – 3
PUMP MAINTENANCE AND REPAIR - SECTION E	PAGE E – 1
STANDARD PERFORMANCE CURVE	PAGE E – 1

TABLE OF CONTENTS
(continued)

PARTS LISTS:	
82K3-(8) PPO	PAGE E – 3
PUMP AND SEAL DISASSEMBLY AND REASSEMBLY	PAGE E – 4
Pump Casing Removal	PAGE E – 4
Impeller Removal	PAGE E – 4
Seal Removal and Disassembly	PAGE E – 4
Seal Reassembly and Installation	PAGE E – 5
Impeller Installation And Adjustment	PAGE E – 6
Pump Casing Installation	PAGE E – 6
Final Pump Assembly	PAGE E – 7
LUBRICATION	PAGE E – 7
Seal Assembly	PAGE E – 7
Engine	PAGE E – 7

INTRODUCTION

Thank You for purchasing a Gorman-Rupp pump. **Read this manual** carefully to learn how to safely install and operate your pump. Failure to do so could result in personal injury or damage to the pump.

This pump is an 80 Series, semi-open impeller, self-priming centrifugal model without a suction check valve. It is designed to be close-coupled to a single cylinder, Briggs and Stratton gasoline engine. The pump is designed for handling most non-volatile, nonflammable liquids containing specified entrained solids. The basic material of construction for wetted parts is gray iron, with gray iron impeller.

Because pump installations are seldom identical, this manual cannot possibly provide detailed instructions and precautions for every aspect of each specific application. Therefore, it is the responsibility of the owner/installer of the pump to ensure that applications not addressed in this manual are performed **only** after establishing that neither operator safety nor pump integrity are compromised by the installation. Pumps and related equipment **must** be installed and operated according to all national, local and industry standards.

If there are any questions regarding the pump or its application which are not covered in this manual or in other literature accompanying this unit, please contact your Gorman-Rupp distributor, or:

The Gorman-Rupp Company
P.O. Box 1217
Mansfield, Ohio 44901-1217
Phone: (419) 755-1011
 or:
Gorman-Rupp of Canada Limited
70 Burwell Road
St. Thomas, Ontario N5P 3R7
Phone: (519) 631-2870

The following are used to alert maintenance personnel to procedures which require special attention, to those which could damage equipment, and to those which could be dangerous to personnel:



Immediate hazards which WILL result in severe personal injury or death. These instructions describe the procedure required and the injury which will result from failure to follow the procedure.



Hazards or unsafe practices which COULD result in severe personal injury or death. These instructions describe the procedure required and the injury which could result from failure to follow the procedure.



Hazards or unsafe practices which COULD result in minor personal injury or product or property damage. These instructions describe the requirements and the possible damage which could result from failure to follow the procedure.

NOTE

Instructions to aid in installation, operation, and maintenance or which clarify a procedure.

SAFETY - SECTION A

This information applies to 80 Series engine driven pumps. Refer to the manual accompanying the engine before attempting to begin operation.

This manual will alert personnel to known procedures which require special attention, to those which could damage equipment, and to those which could be dangerous to personnel. However, this manual cannot possibly anticipate and provide detailed instructions and precautions for every situation that might occur during maintenance of the unit. Therefore, it is the responsibility of the owner/maintenance personnel to ensure that only safe, established maintenance procedures are used, and that any procedures not addressed in this manual are performed only after establishing that neither personal safety nor pump integrity are compromised by such practices.



WARNING

Before attempting to open or service the pump:

1. Familiarize yourself with this manual.
2. Shut down the engine and disconnect the spark plug wire to ensure that the pump will remain inoperative.
3. Allow the pump to completely cool if overheated.
4. Check the temperature before opening any covers, plates, or plugs.
5. Close the suction and discharge valves.
6. Vent the pump slowly and cautiously.
7. Drain the pump.



WARNING

This pump is designed to handle most non-volatile, non-flammable liquids containing specified entrained solids. Do not attempt to pump volatile, corrosive, or flammable liquids which may damage the pump or endanger personnel as a result of pump failure.



WARNING!

Be certain proper safety practices are followed before operating or servicing the pump. Do not disassemble the pump in an explosive atmosphere. Provide adequate ventilation, prohibit smoking, wear static-resistant clothing and shoes. Clean up all fuel spills immediately after occurrence.



WARNING

After the pump has been installed, make certain that the pump and all piping or hose connections are tight, properly supported and secure before operation.



WARNING

Do not operate the pump against a closed discharge valve for long periods of time. If operated against a closed discharge valve, pump components will deteriorate, and the liquid could come to a boil, build pressure, and cause the pump casing to rupture or explode.



WARNING

Overheated pumps can cause severe burns and injuries. If overheating of the pump occurs:

1. Stop the pump immediately.

2. Ventilate the area.
3. Allow the pump to completely cool.
4. Check the temperature before opening any covers, plates, gauges, or plugs.
5. Vent the pump slowly and cautiously.
6. Refer to instructions in this manual before restarting the pump.

**WARNING**

Do not remove plates, covers, gauges, pipe plugs, or fittings from an overheated pump. Vapor pressure within the pump can cause parts being disengaged to be ejected with great force. Allow the pump to completely cool before servicing.

**WARNING!**

Do not operate an internal combustion engine in an explosive atmosphere. When operating internal combustion engines in an enclosed area, make certain that exhaust fumes are piped to the

outside. These fumes contain carbon monoxide, a deadly gas that is colorless, tasteless, and odorless.

**WARNING!**

Fuel used by internal combustion engines presents an extreme explosion and fire hazard. Make certain that all fuel lines are securely connected and free of leaks. Never refuel a hot or running engine. Avoid overfilling the fuel tank. Always use the correct type of fuel.

**WARNING!**

Never tamper with the governor to gain more power. The governor establishes safe operating limits that should not be exceeded.

**CAUTION**

Pumps and related equipment must be installed and operated according to all national, local and industry standards.

INSTALLATION – SECTION B

Review all **SAFETY** information in Section A.

Follow the instructions on all tags, labels and decals attached to the pump.



Do not test or operate this pump before reading the installation and operation instructions in this manual.

Since pump installations are seldom identical, this section offers only general recommendations and practices required to inspect, position, and arrange the pump and piping.

Most of the information pertains to a standard **static lift** application where the pump is positioned above the free level of liquid to be pumped.

If installed in a **flooded suction application** where the liquid is supplied to the pump under pressure, some of the information such as mounting, line configuration, and priming must be tailored to the specific application. Since the pressure supplied to the pump is critical to performance and safety, **be sure** to limit the incoming pressure to 50% of the maximum permissible operating pressure as shown on the pump performance curve (see Section E, Page 1).

For further assistance, contact your Gorman-Rupp distributor or the Gorman-Rupp Company.

POSITIONING PUMP

Lifting



Use lifting and moving equipment in good repair and with adequate capacity to prevent injuries to personnel or damage to equipment.

Pump unit weights will vary depending on the mounting and drive provided. Check the shipping tag on the unit packaging for the actual weight, and use lifting equipment with appropriate capacity. Drain the pump and remove all customer-installed equipment such as suction and discharge hoses or piping before attempting to lift existing, installed units.

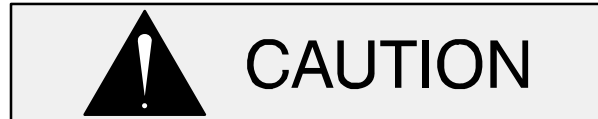

The pump assembly can be seriously damaged if the cables or chains used to lift and move the unit are improperly wrapped around the pump.

Mounting

Locate the pump in an accessible place as close as practical to the liquid being pumped. Level mounting is essential for proper operation.

The pump may have to be supported or shimmed to provide for level operation or to eliminate vibration.

If the pump has been mounted on a moveable base, make certain the base is stationary by setting the brake and blocking the wheels before attempting to operate the pump.

To ensure sufficient lubrication and fuel supply to the engine, **do not** position the pump and engine more than 15° off horizontal for continuous operation. The pump and engine may be positioned up to 30° off horizontal for **intermittent operation only**; however, the engine manufacturer should be consulted for continuous operation at angles greater than 15°.

SUCTION AND DISCHARGE PIPING

Pump performance is adversely effected by increased suction lift, discharge elevation, and friction losses. See the performance curve and notes

on Page E-1 to be sure your overall application allows pump to operate within the safe operation range.

Materials

Either pipe or hose may be used for suction and discharge lines; however, the materials must be compatible with the liquid being pumped. If hose is used in suction lines, it must be the rigid-wall, reinforced type to prevent collapse under suction. Using piping couplings in suction lines is not recommended.

Line Configuration

Keep suction and discharge lines as straight as possible to minimize friction losses. Make minimum use of elbows and fittings, which substantially increase friction loss. If elbows are necessary, use the long-radius type to minimize friction loss.

Connections to Pump

Before tightening a connecting flange, align it exactly with the pump port. Never pull a pipe line into place by tightening the flange bolts and/or couplings.

Lines near the pump must be independently supported to avoid strain on the pump which could cause excessive vibration, decreased bearing life, and increased shaft and seal wear. If hose-type lines are used, they should have adequate support to secure them when filled with liquid and under pressure.

Gauges

Most pumps are drilled and tapped for installing discharge pressure and vacuum suction gauges. If these gauges are desired for pumps that are not tapped, drill and tap the suction and discharge lines not less than 18 inches (457,2 mm) from the suction and discharge ports and install the lines. Installation closer to the pump may result in erratic readings.

SUCTION LINES

To avoid air pockets which could affect pump priming, the suction line must be as short and direct as possible. When operation involves a suction lift, the line must always slope upward to the pump from the source of the liquid being pumped; if the line slopes down to the pump at any point along the suction run, air pockets will be created.

Fittings

Suction lines should be the same size as the pump inlet. If reducers are used in suction lines, they should be the eccentric type, and should be installed with the flat part of the reducers uppermost to avoid creating air pockets. Valves are not normally used in suction lines, but if a valve is used, install it with the stem horizontal to avoid air pockets.

Strainers

If a strainer is furnished with the pump, be certain to use it; any spherical solids which pass through a strainer furnished with the pump will also pass through the pump itself.

If a strainer is not furnished with the pump, but is installed by the pump user, make certain that the total area of the openings in the strainer is at least three or four times the cross section of the suction line, and that the openings will not permit passage of solids larger than the solids handling capability of the pump.

Sealing

Since even a slight leak will affect priming, head, and capacity, especially when operating with a high suction lift, all connections in the suction line should be sealed with pipe dope to ensure an air-tight seal. Follow the sealant manufacturer's recommendations when selecting and applying the pipe dope. The pipe dope should be compatible with the liquid being pumped.

Suction Lines In Sumps

If a single suction line is installed in a sump, it should be positioned away from the wall of the sump at a distance equal to 1-1/2 times the diameter of the suction line.

If there is a liquid flow from an open pipe into the sump, the flow should be kept away from the suction inlet because the inflow will carry air down into the sump, and air entering the suction line will reduce pump efficiency.

If it is necessary to position inflow close to the suction inlet, install a baffle between the inflow and the suction inlet at a distance 1-1/2 times the diameter of the suction pipe. The baffle will allow entrained air to escape from the liquid before it is drawn into the suction inlet.

If two suction lines are installed in a single sump, the flow paths may interact, reducing the efficiency

of one or both pumps. To avoid this, position the suction inlets so that they are separated by a distance equal to at least 3 times the diameter of the suction pipe.

Suction Line Positioning

The depth of submergence of the suction line is critical to efficient pump operation. Figure 1 shows recommended minimum submergence vs. velocity.

NOTE

The pipe submergence required may be reduced by installing a standard pipe increaser fitting at the end of the suction line. The larger opening size will reduce the inlet velocity. Calculate the required submergence using the following formula based on the increased opening size (area or diameter).

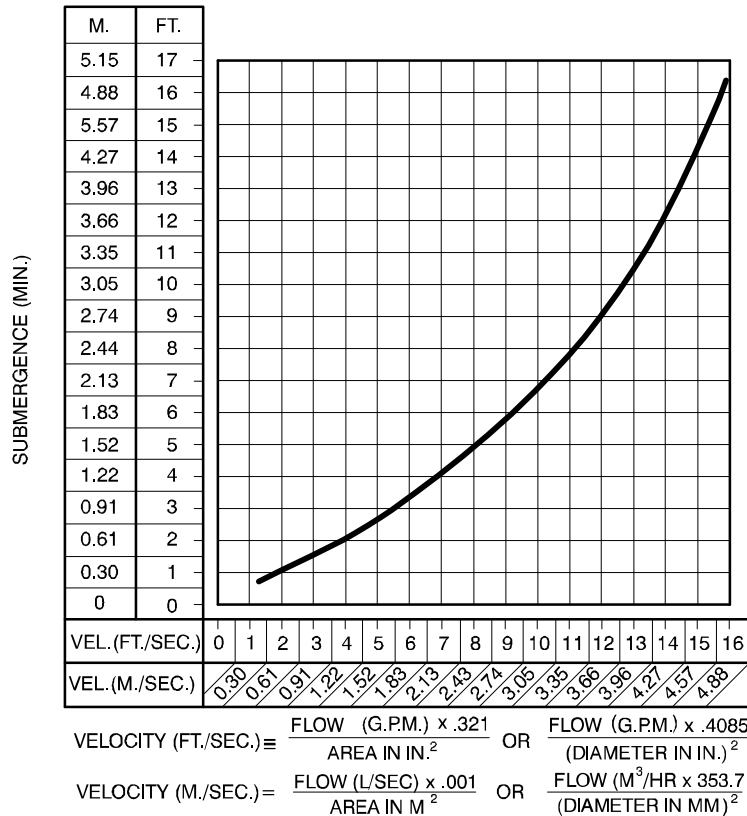

Figure 1. Recommended Minimum Suction Line Submergence vs. Velocity

DISCHARGE LINES

Siphoning

Do not terminate the discharge line at a level lower than that of the liquid being pumped unless a siphon breaker is used in the line. Otherwise, a siphoning action causing damage to the pump could result.

Valves

If a throttling valve is desired in the discharge line, use a valve as large as the largest pipe to minimize friction losses. Never install a throttling valve in a suction line.

A check valve in the discharge line is normally recommended, but it is not necessary in low discharge head applications.

With high discharge heads, it is recommended that a throttling valve and a system check valve be in-

stalled in the discharge line to protect the pump from excessive shock pressure and reverse rotation when it is stopped.

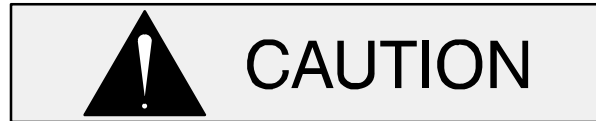

If the application involves a high discharge head, gradually close the discharge throttling valve before stopping the pump.

Bypass Lines

If a system check valve is used due to high discharge head, it may be necessary to vent trapped air from the top of the pump during the priming process. This may be accomplished by installing a bypass line from the top of the pump, back to the source of liquid. The end of the bypass line must be submerged. The line must be large enough to prevent clogging, but not so large as to affect pump discharge capacity.

OPERATION – SECTION C

Review all information in Safety, Section A.

Follow the instructions on all tags, labels and decals attached to the pump.



This pump is designed to handle most non-volatile, non-flammable liquids containing specified entrained solids. Do not attempt to pump volatile, corrosive, or flammable liquids which may damage the pump or endanger personnel as a result of pump failure.



Never tamper with the governor to gain more power. the governor establishes safe operating limits that should not be exceeded.

PRIMING

Install the pump and piping as described in **INSTALLATION**. Make sure that the piping connections are tight, and that the pump is securely mounted. Check that the pump is properly lubricated (see **LUBRICATION** in **MAINTENANCE AND REPAIR**).

This pump is self-priming, but the pump should never be operated unless there is liquid in the pump casing.



Never operate this pump unless there is liquid in the pump casing. the pump will not prime when dry. Extended operation of a dry pump will destroy the seal assembly.

Add liquid to the pump casing when:

1. The pump is being put into service for the first time.
2. The pump has not been used for a considerable length of time.
3. The liquid in the pump casing has evaporated.

Once the pump casing has been filled, the pump will prime and reprime as necessary.



After filling the pump casing, reinstall and tighten the fill plug. do not attempt to operate the pump unless all connecting piping is securely installed. otherwise, liquid in the pump forced out under pressure could cause injury to personnel.

To fill the pump, remove the pump casing fill cover or fill plug in the top of the casing, and add clean liquid until the casing is filled. Replace the fill cover or fill plug before operating the pump.

STARTING

Consult the operations manual furnished with the engine.

OPERATION



Pump speed and operating condition points must be within the continuous performance range shown on the curve (see Section E, Page 1).

Lines With a Bypass

Close the discharge throttling valve (if so equipped) so that the pump will not have to prime against the weight of the liquid in the discharge

line. Air from the suction line will be discharged through the bypass line back to the wet well during the priming cycle. When the pump is fully primed and liquid is flowing steadily from the bypass line, open the discharge throttling valve. Liquid will then continue to circulate through the bypass line while the pump is in operation.

Lines Without a Bypass

Open all valves in the discharge line and start the engine. Priming is indicated by a positive reading on the discharge pressure gauge or by a quieter operation. The pump may not prime immediately because the suction line must first fill with liquid. If the pump fails to prime within five minutes, stop it and check the suction line for leaks.

After the pump has been primed, partially close the discharge line throttling valve in order to fill the line slowly and guard against excessive shock pressure which could damage pipe ends, gaskets, sprinkler heads, and any other fixtures connected to the line. When the discharge line is completely filled, adjust the throttling valve to the required flow rate.

Leakage

No leakage should be visible at pump mating surfaces, or at pump connections or fittings. Keep all line connections and fittings tight to maintain maximum pump efficiency.

Liquid Temperature And Overheating

The **maximum** liquid temperature for this pump is 160° F (71° C). Do not apply it at a higher operating temperature.

Overheating can occur if operated with the valves in the suction or discharge lines closed. Operating against closed valves could bring the liquid to a boil, build pressure, and cause the pump to rupture or explode. If overheating occurs, stop the pump and allow it to cool before servicing it. Refill the pump casing with cool liquid.



WARNING

Do not remove plates, covers, gauges, pipe plugs, or fittings from an overheated pump. Vapor pressure within the pump can cause parts being disengaged to be ejected with great force. Allow the pump to cool before servicing.

Strainer Check

If a suction strainer has been shipped with the pump or installed by the user, check the strainer regularly, and clean it as necessary. The strainer should also be checked if pump flow rate begins to drop. If a vacuum suction gauge has been installed, monitor and record the readings regularly to detect strainer blockage.

Never introduce air or steam pressure into the pump casing or piping to remove a blockage. This could result in personal injury or damage to the equipment. If backflushing is absolutely necessary, **liquid pressure** must be limited to 50% of the maximum permissible operating pressure shown on the pump performance curve (see Section E, Page 1).

Pump Vacuum Check

With the pump inoperative, install a vacuum gauge in the system, using pipe dope on the threads. Block the suction line and start the pump. At operating speed the pump should pull a vacuum of 20 inches (508,0 mm) or more of mercury. If it does not, check for air leaks in the seal, gasket, or discharge valve.

Open the suction line, and read the vacuum gauge with the pump primed and at operation speed. Shut off the pump. The vacuum gauge reading will immediately drop proportionate to static suction lift, and should then stabilize. If the vacuum reading falls off rapidly after stabilization, an air leak exists. Before checking for the source of the leak, check the point of installation of the vacuum gauge.

STOPPING

Never halt the flow of liquid suddenly. If the liquid being pumped is stopped abruptly, damaging

shock waves can be transmitted to the pump and piping system. Close all connecting valves slowly.

On engine driven pumps, reduce the throttle speed slowly and allow the engine to idle briefly before stopping.



If the application involves a high discharge head, gradually close the discharge throttling valve before stopping the pump.

After stopping the pump, remove the spark plug wire to ensure that the pump will remain inoperative.

Cold Weather Preservation

In below freezing conditions, drain the pump to prevent damage from freezing. Also, clean out any solids by flushing with a hose. Operate the pump for approximately one minute; this will remove any remaining liquid that could freeze the pump rotating parts. If the pump will be idle for more than a few hours, or if it has been pumping liquids containing a large amount of solids, drain the pump, and flush it thoroughly with clean water. To prevent large solids from clogging the drain port and preventing the pump from completely draining, insert a rod or stiff wire in the drain port, and agitate the liquid during the draining process. Clean out any remaining solids by flushing with a hose.

TROUBLESHOOTING – SECTION D

Review all Safety information in Section A.



Before attempting to open or service the pump:

1. Familiarize yourself with this manual.
2. Shut down the engine and disconnect the spark plug wire to ensure that the pump will remain inoperative.
3. Allow the pump to completely cool if overheated.
4. Check the temperature before opening any covers, plates, or plugs.
5. Close the suction and discharge valves.
6. Vent the pump slowly and cautiously.
7. Drain the pump.

TROUBLE	POSSIBLE CAUSE	PROBABLE REMEDY
PUMP FAILS TO PRIME	<p>Not enough liquid in casing.</p> <p>Suction check valve contaminated or damaged.</p> <p>Air leak in suction line.</p> <p>Lining of suction hose collapsed.</p> <p>Leaking or worn seal or pump gasket.</p> <p>Suction check valve or foot valve clogged or binding.</p> <p>Pump speed too slow.</p> <p>Suction lift or discharge head too high.</p> <p>Strainer clogged.</p>	<p>Add liquid to casing. See PRIMING.</p> <p>Clean or replace check valve.</p> <p>Correct leak.</p> <p>Replace suction hose.</p> <p>Check pump vacuum. Replace leaking or worn seal or gasket.</p> <p>Clean valve.</p> <p>Check engine output; consult engine operation manual.</p> <p>Check piping installation and install bypass line if needed. See INSTALLATION.</p> <p>Check strainer and clean if necessary.</p>

TROUBLE	POSSIBLE CAUSE	PROBABLE REMEDY
PUMP STOPS OR FAILS TO DELIVER RATED FLOW OR PRESSURE	<p>Air leak in suction line.</p> <p>Lining of suction hose collapsed.</p> <p>Leaking or worn seal or pump gasket.</p> <p>Suction intake not submerged at proper level or sump too small.</p> <p>Impeller or other wearing parts worn or damaged.</p> <p>Strainer clogged.</p> <p>Impeller clogged.</p> <p>Suction lift or discharge head too high.</p> <p>Pump speed too slow.</p>	<p>Correct leak.</p> <p>Replace suction hose.</p> <p>Check pump vacuum. Replace leaking or worn seal or gasket.</p> <p>Check installation and correct submergence as needed.</p> <p>Replace worn or damaged parts. Check that impeller is properly centered and rotates freely.</p> <p>Check strainer and clean if necessary.</p> <p>Free impeller of debris.</p> <p>Check piping installation and install bypass line if needed. See INSTALLATION.</p> <p>Check engine output; consult engine operation manual.</p>
PUMP REQUIRES TOO MUCH POWER	<p>Pump speed too high.</p> <p>Discharge head too low.</p> <p>Liquid solution too thick.</p>	<p>Check driver output; check that sheaves or couplings are correctly sized.</p> <p>Adjust discharge valve.</p> <p>Dilute if possible.</p>
PUMP CLOGS FREQUENTLY	<p>Discharge flow too slow.</p> <p>Suction check valve or foot valve clogged or binding.</p> <p>Discharge line clogged or restricted; hose kinked.</p>	<p>Open discharge valve fully to increase flow rate, and run engine at maximum governed speed.</p> <p>Clean valve.</p> <p>Check discharge lines; straighten hose.</p>
EXCESSIVE NOISE	<p>Cavitation in pump.</p> <p>Pumping entrained air.</p> <p>Pump or drive not securely mounted.</p> <p>Impeller clogged or damaged.</p>	<p>Reduce suction lift and/or friction losses in suction line. Record vacuum and pressure gauge readings and consult local representative or factory.</p> <p>Locate and eliminate source of air bubble.</p> <p>Secure mounting hardware.</p>

PREVENTIVE MAINTENANCE

Since pump applications are seldom identical, and pump wear is directly affected by such things as the abrasive qualities, pressure and temperature of the liquid being pumped, this section is intended only to provide general recommendations and practices for preventive maintenance. Regardless of the application however, following a routine preventive maintenance schedule will help assure trouble-free performance and long life from your Gorman-Rupp pump. For specific questions concerning your application, contact your Gorman-Rupp distributor or the Gorman-Rupp Company.

Record keeping is an essential component of a good preventive maintenance program. Changes in suction and discharge gauge readings (if so

equipped) between regularly scheduled inspections can indicate problems that can be corrected before system damage or catastrophic failure occurs. The appearance of wearing parts should also be documented at each inspection for comparison as well. Also, if records indicate that a certain part (such as the seal) fails at approximately the same duty cycle, the part can be checked and replaced before failure occurs, reducing unscheduled down time.

For new applications, a first inspection of wearing parts at 250 hours will give insight into the wear rate for your particular application. Subsequent inspections should be performed at the intervals shown on the chart below. Critical applications should be inspected more frequently.

Preventive Maintenance Schedule					
Item	Service Interval*				
	Daily	Weekly	Monthly	Semi-Annually	Annually
General Condition (Temperature, Unusual Noises or Vibrations, Cracks, Leaks, Loose Hardware, Etc.)	I				
Pump Performance (Gauges, Speed, Flow)	I				
Bearing Lubrication		I			R
Seal Lubrication (And Packing Adjustment, If So Equipped)		I			R
V-Belts (If So Equipped)			I		
Air Release Valve Plunger Rod (If So Equipped)			I	C	
Front Impeller Clearance (Wear Plate)				I	
Rear Impeller Clearance (Seal Plate)				I	
Check Valve					I
Pressure Relief Valve (If So Equipped)					C
Pump and Driver Alignment					I
Shaft Deflection					I
Bearings					I
Bearing Housing					I
Piping					I
Driver Lubrication – See Mfgr’s Literature					I

Legend:
 I = Inspect, Clean, Adjust, Repair or Replace as Necessary
 C = Clean
 R = Replace

* Service interval based on an intermittent duty cycle equal to approximately 4000 hours annually. Adjust schedule as required for lower or higher duty cycles or extreme operating conditions.

PUMP MAINTENANCE AND REPAIR - SECTION E

MAINTENANCE AND REPAIR OF THE WEARING PARTS OF THE PUMP WILL MAINTAIN PEAK OPERATING PERFORMANCE.

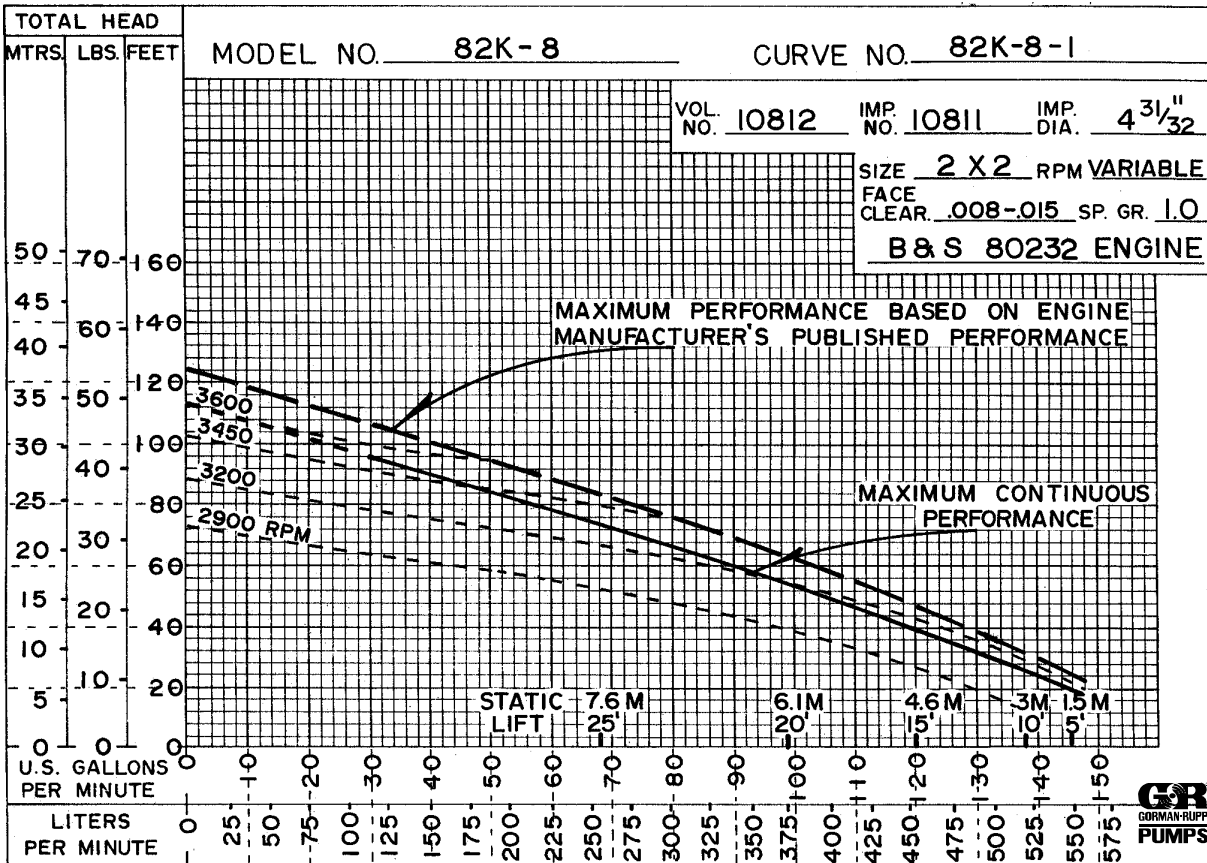

C-12-74 -REV.

*** STANDARD PERFORMANCE FOR PUMP MODEL 82K3-(8) PPO**

* Based on 70° F (21° C) clear water at sea level with minimum suction lift. Since pump installations are seldom identical, your performance may be difference due to such factors as viscosity, specific gravity, elevation, temperature, and impeller trim.

Contact the Gorman-Rupp Company to verify performance or part numbers.

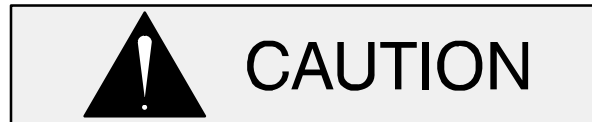

Pump speed and operating condition points must be within the continuous performance range shown on the curve.

If your pump serial number is followed by an "N", your pump is **NOT** a standard production model.

SECTION DRAWING

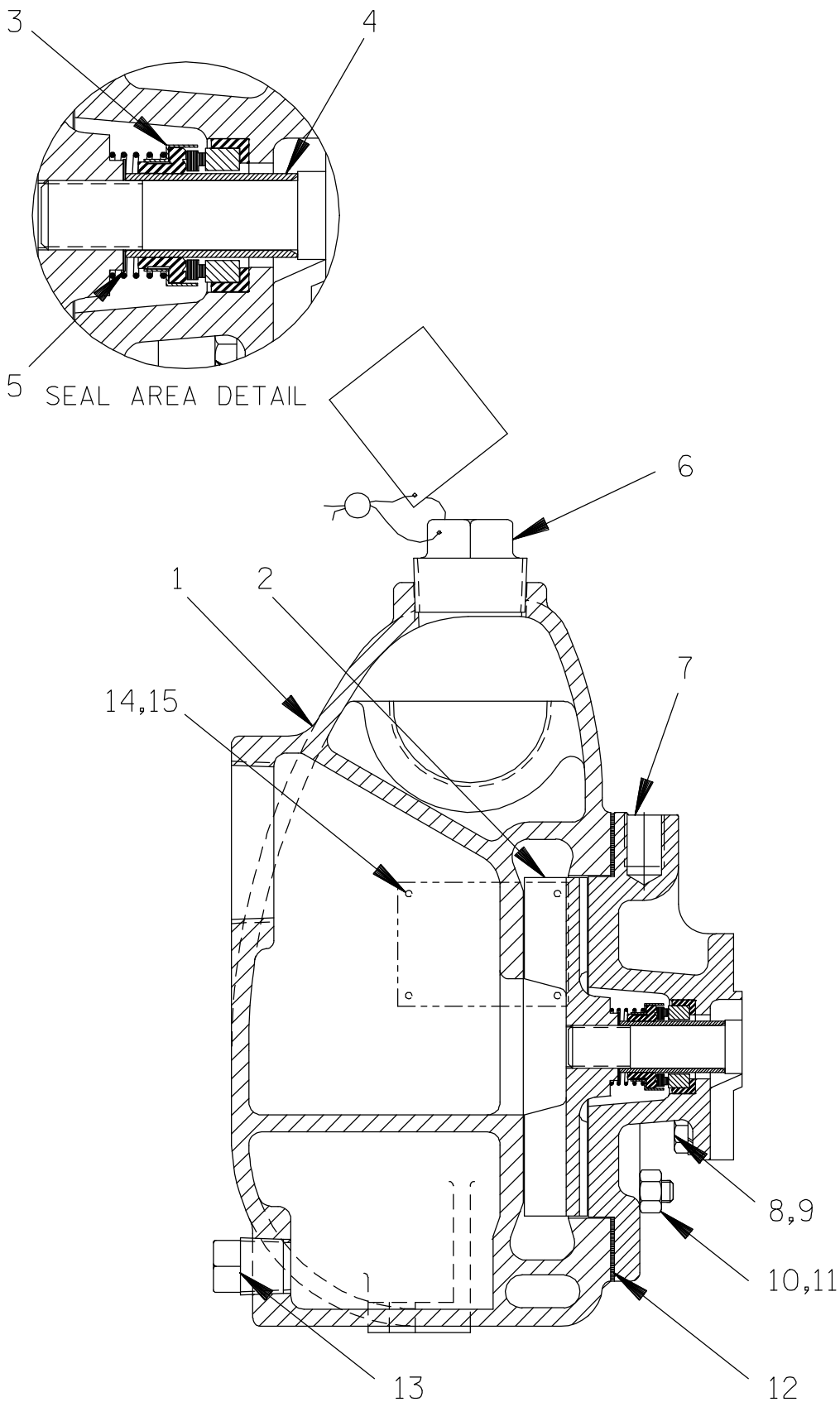

Figure 1. Pump Model 82K3-(8) PPO

PARTS LIST
Pump Model 82K3-(8) PPO
 (From S/N 864439 Up)

ITEM NO.	PART NAME	PART NUMBER	MAT'L CODE	QTY
1	PUMP CASING	10812	10010	1
2	* IMPELLER	10811	10010	1
3	* SEAL ASSEMBLY	S1575	---	1
4	* SHAFT SLEEVE	2353	14090	1
5	IMPELLER ADJUSTING SHIM SET	513A	17090	REF
6	FILL PLUG ASSEMBLY	48271-065	---	1
7	INTERMEDIATE BRACKET	10813	10010	1
8	HEX HD CAPSCREW	B0503-1/2S	15991	5
9	LOCK WASHER	J05	15991	4
10	STUD	C0605	15991	4
11	HEX NUT	D06	15991	4
12	* PUMP CASING GASKET SET	504G	18000	1
13	PIPE PLUG	P08	15079	1
14	NAME PLATE	38812-041	13990	1
15	DRIVE SCREW	BM#04-03	17000	1
NOT SHOWN:				
	STRAINER	26841-025	---	1
	G-R DECAL	GR-03	---	1
	INSTRUCTION TAG	38817-085	---	1
	SUCTION STICKER	6588AG	---	1
	PRIMING STICKER	6588AH	---	1
	DISCHARGE STICKER	6588BJ	---	1

* INDICATES PARTS RECOMMENDED FOR STOCK

PUMP AND SEAL DISASSEMBLY AND REASSEMBLY

Review all SAFETY information in Section A.

Follow the instructions on all tags, label and decals attached to the pump.

This pump requires little service due to its rugged, minimum-maintenance design. However, if it becomes necessary to inspect or replace the wearing parts, follow these instructions which are keyed to the sectional view (see Figure 1) and the accompanying parts list.

This manual will alert personnel to known procedures which require special attention, to those which could damage equipment, and to those which could be dangerous to personnel. However, this manual cannot possibly anticipate and provide detailed precautions for every situation that might occur during maintenance of the unit. Therefore, it is the responsibility of the owner/maintenance personnel to ensure that **only** safe, established maintenance procedures are used, and that any procedures not addressed in this manual are performed **only** after establishing that neither personal safety nor pump integrity are compromised by such practices.

Before attempting to service the pump, shut down the engine and disconnect the spark plug wire to ensure that it will remain inoperative. Close all valves in the suction and discharge lines.

For engine disassembly and repair, consult the literature supplied with the engine, or contact your local engine representative.



Before attempting to open or service the pump:

1. **Familiarize yourself with this manual.**
2. **Shut down the engine and disconnect the spark plug wire to ensure that the pump will remain inoperative.**

3. **Allow the pump to completely cool if overheated.**
4. **Check the temperature before opening any covers, plates, or plugs.**
5. **Close the suction and discharge valves.**
6. **Vent the pump slowly and cautiously.**
7. **Drain the pump.**

Pump Casing Removal

To service the impeller or seal assembly, disconnect the discharge piping. Remove the hardware securing the pump casing to the base.

Tie and tag any leveling shims used under the casing mounting feet for ease of reassembly.

Remove the nuts (11) and separate the pump casing (1) and gasket set (12) from the intermediate (7). Clean the mating surfaces of the intermediate and pump casing. Tie and tag the gaskets, or measure and record their thickness for ease of reassembly.

Impeller Removal

To loosen the impeller (2), tap the vanes of the impeller in a counterclockwise direction (when facing the impeller) with a block of wood or a soft-faced mallet. **Be careful** not to damage the impeller vanes. Use caution when removing the impeller; tension on the seal spring will be released as the impeller is unscrewed.

Inspect the impeller and replace it if cracked or badly worn. Remove the impeller adjusting shims (4) from the shaft. Tie and tag the shims or measure and record their thickness for ease of reassembly.

Seal Removal and Disassembly

(Figures 1 and 2)

Remove the seal spring. Slide shaft sleeve (4) and rotating portion of the seal off the shaft as a unit. Apply oil to the sleeve and work it under the bellows. Slide the rotating portion of the seal off the sleeve.

To remove the stationary seat, remove the hardware (8 and 9) and slide the stationary portion of

the seal and intermediate (7) off the shaft as a unit. Position the intermediate on a flat surface with the impeller side down. Use thumb pressure to press the stationary element and seat from the intermediate.

If no further disassembly is required, see **Seal Reassembly and Installation**.

Seal Reassembly and Installation

(Figures 1 and 2)

Clean the seal cavity and shaft with a cloth soaked in fresh cleaning solvent.



Most cleaning solvents are toxic and flammable. Use them only in a well ventilated area free from excessive heat, sparks, and flame. Read and follow all precautions printed on solvent containers.

Inspect the engine shaft for damage. Small scratches or nicks may be removed with a fine file or emery cloth. If excessive wear exists, the shaft will have to be replaced (refer to the engine service manual).

The seal is not normally reused because wear patterns on the finished faces cannot be realigned during reassembly. This could result in premature failure. If necessary to reuse an old seal in an emergency, **carefully** wash all metallic parts in **fresh** cleaning solvent and allow to dry thoroughly.

Handle the seal parts with extreme care to prevent damage. Be careful not to contaminate precision finished faces; even fingerprints on the faces can shorten seal life. If necessary, clean the faces with a non-oil based solvent and a clean, lint-free tissue. Wipe **lightly** in a concentric pattern to avoid scratching the faces.

Inspect the seal components for wear, scoring, grooves, and other damage that might cause leakage. Clean and polish the shaft sleeve, or replace it if there are nicks or cuts on either end. If any components are worn, replace the complete seal; **never mix old and new seal parts**.

If a replacement seal is being used, remove it from the container and inspect the precision finished faces to ensure that they are free of any foreign matter.

To ease installation of the seal, lubricate the shaft sleeve with water or a very **small** amount of oil, and apply a drop of light lubricating oil on the finished faces. Assemble the seal as follows, (see Figure 2).

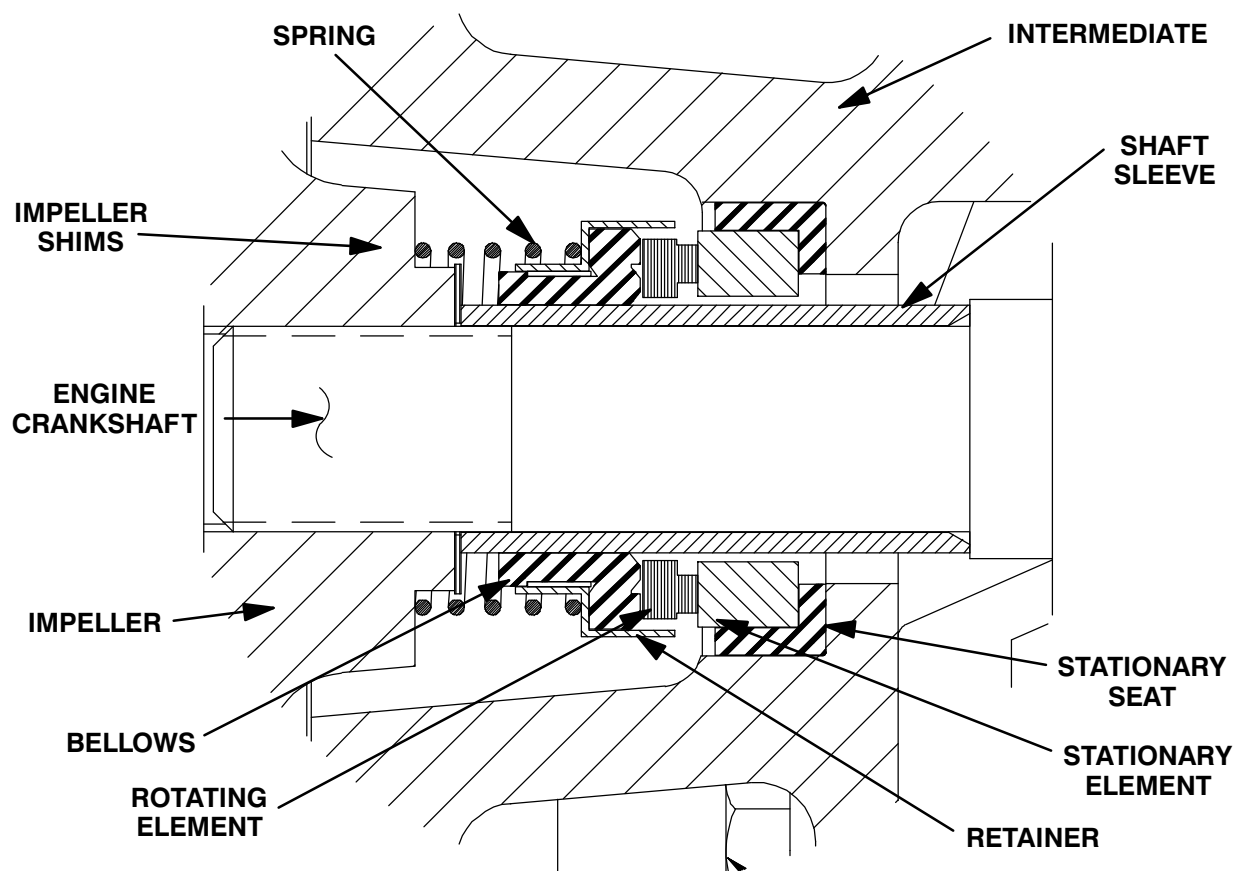

Figure 2. Seal Assembly



This seal is not designed for operation at temperatures above 160°F (71°C). Do not use at higher operating temperatures.

Install the stationary element in the stationary seat. Lubricate the O.D. of the stationary seat and press this stationary subassembly into the intermediate (7) until fully seated. After installation, wipe the sealing face lightly in a concentric pattern with a clean, lint-free tissue.

Position the intermediate and stationary subassembly over the shaft and against the engine. Use caution not to damage the stationary sealing element. Secure the intermediate to the engine with the hardware (8 and 9).

Slide the rotating subassembly (consisting of the rotating element, bellows and retainer) over the lubricated shaft sleeve (4) until the rotating element is **just flush** with the chamfered end of the sleeve. Slide the sleeve over the shaft until the sealing

faces contact. Continue to press the shaft sleeve through the seal assembly until it seats squarely against the shaft shoulder.

Install the seal spring.

Impeller Installation And Adjustment

Inspect the impeller, and replace it if cracked or badly worn. Install the same thickness of impeller shims (5) as previously removed, and screw the impeller onto the shaft until tight.

A clearance of .010 to .020 inch (0,25 to 0,50 mm) between the impeller and the intermediate is necessary for maximum pump efficiency. Measure this clearance and add or remove impeller shims until this clearance is reached.

Pump Casing Installation

Install the same thickness of pump casing gaskets (12) as previously removed and secure the pump casing to the intermediate with the nuts (11). **Do not** fully tighten the nuts at this time.

A clearance of .008 to .015 inch (0,20 to 0,38 mm) between the impeller and the pump casing is also recommended for maximum pump efficiency. Set this clearance by adding or removing gaskets in the pump casing gasket set (12) until the impeller scrapes against the wear plate when the shaft is turned. After the impeller scrapes, add approximately .008 inch (0,20 mm) of gaskets.

After the face clearance has been set, tighten the nuts securing the pump casing to the intermediate.

Secure the pump casing to the base with the previously removed hardware. Be sure to reinstall any leveling shims used under the casing mounting feet.

Final Pump Assembly

Be sure the pump and engine are securely mounted to the base.

Install the suction and discharge lines and open all valves. Make certain that all piping connections are tight, properly supported and secure.

Be sure the pump and engine have been properly lubricated, see **LUBRICATION**.

Remove the fill plug (6) and fill the pump casing with clean liquid. Reinstall the fill plug and tighten it.

Refer to **OPERATION**, Section C, before putting the pump back into service.

LUBRICATION

Seal Assembly

The seal assembly is lubricated by the medium being pumped, and no additional lubrication is required.

Engine

Consult the literature supplied with the engine, or contact your local engine representative.

**For U.S. and International Warranty Information,
Please Visit www.grpumps.com/warranty**

or call:

U.S.: 419-755-1280

International: +1-419-755-1352

**For Canadian Warranty Information,
Please Visit www.grcanada.com/warranty**

or call:

519-631-2870