

80SERIES™

INSTALLATION, OPERATION, PARTS LIST, AND MAINTENANCE MANUAL

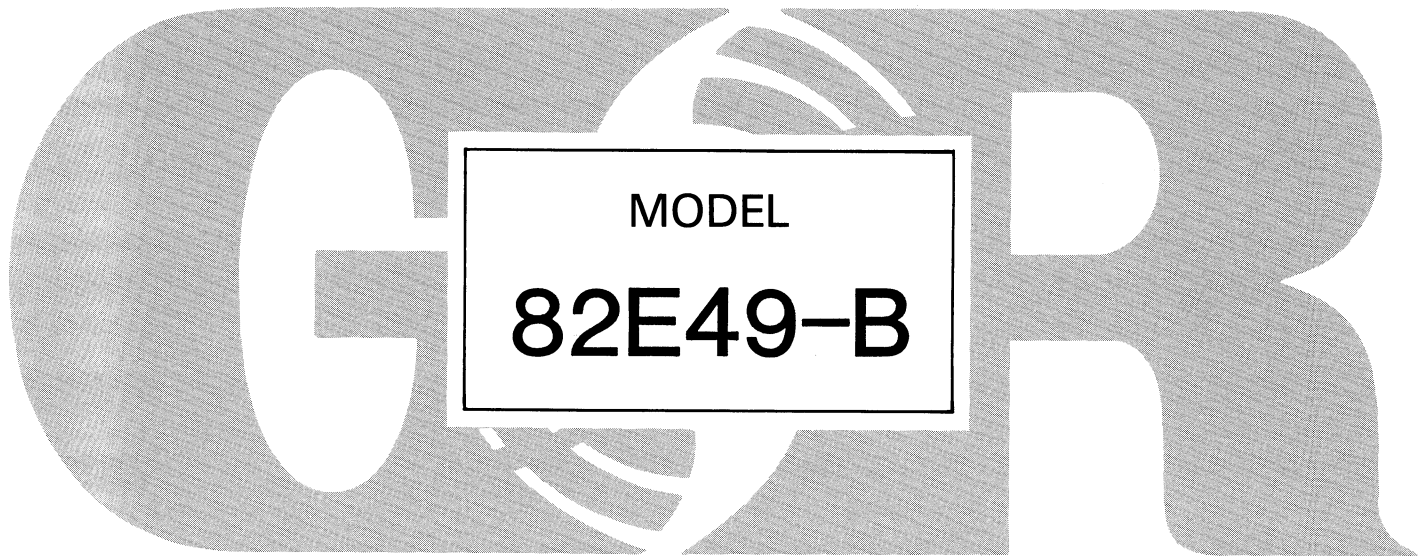

THE GORMAN-RUPP COMPANY • MANSFIELD, OHIO

GORMAN-RUPP OF CANADA LIMITED • ST. THOMAS, ONTARIO, CANADA

Printed in U.S.A.

Copyright by the Gorman-Rupp Company

TABLE OF CONTENTS

INTRODUCTION	I-1
WARNINGS - SECTION A	A-1
COMPATABILITY APPLICATION RECOMMENDATION CHART	A-3
INSTALLATION - SECTION B	B-1
Pump Dimensions	B-1
PREINSTALLATION INSPECTION	B-2
POSITIONING PUMP	B-3
Lifting	B-3
Mounting	B-4
Recommended Pump Installation	B-4
SUCTION AND DISCHARGE PIPING	B-5
Materials	B-5
Line Configuration	B-6
Connections to Pump	B-6
Gauges	B-6
SUCTION LINES	B-6
Fittings	B-7
Strainers	B-7
Sealing	B-7
Suction Lines In Sumps	B-7
Suction Line Positioning	B-8
DISCHARGE LINES	B-8
Siphoning	B-8
Valves	B-9
Bypass Lines	B-9
ALIGNMENT	B-10
Coupled Drives	B-11
V-Belt Drives	B-11
OPERATION - SECTION C	C-1
PRIMING	C-1
STARTING	C-2
Rotation	C-2
OPERATION	C-2
Lines With a Bypass	C-2
Lines Without a Bypass	C-3
Leakage	C-3
Liquid Temperature And Overheating	C-3
Strainer Check	C-3
Pump Vacuum Check	C-4
STOPPING	C-4
Cold Weather Preservation	C-4
BEARING TEMPERATURE CHECK	C-4
TROUBLESHOOTING - SECTION D	D-1
MAINTENANCE AND REPAIR - SECTION E	E-1
PERFORMANCE CURVE	E-1
PUMP MODEL - PARTS LIST	E-3
PUMP AND SEAL DISASSEMBLY AND REASSEMBLY	E-4
Suction Check Valve Removal	E-4
Pump Disassembly	E-5
Seal Disassembly	E-6
Impeller Shaft And Bearing Disassembly	E-6
Impeller Shaft And Bearing Reassembly	E-7
Seal Reassembly	E-9
Pump Reassembly	E-11
Suction Check Valve Installation	E-12
Final Pump Reassembly	E-12

LUBRICATION	E-12
Seal Assembly	E-12
Bearings	E-12

INTRODUCTION

This Installation, Operation, and Maintenance Manual is designed to help you achieve the best performance and longest life from your Gorman-Rupp pump.

This pump is an 80 Series, semi-open impeller, self-priming centrifugal model with a suction check valve. The pump is designed for handling liquids containing non-abrasive chemicals. This pump is **not** recommended for solutions in concentrations which will 'salt-out' or form precipitates. The basic material of construction (pump casing, flanges, seal plate and impeller) is fiberglass-reinforced thermosetting polyester. All other wetted parts are Type 316 stainless steel.

This pump will safely handle chemicals and chemical waste solutions of the concentrations and temperatures shown on the chart on Page A-3.

If there are any questions regarding the pump or its application which are not covered in this manual or in other literature accompanying this unit, please contact your Gorman-Rupp distributor, or write:

The Gorman-Rupp Company	or	Gorman-Rupp of Canada Limited
P.O. Box 1217		70 Burwell Road
Mansfield, Ohio 44901		St. Thomas, Ontario N5P 3R7

For information or technical assistance on the power source, contact the power source manufacturer's local dealer or representative.

The following are used to alert maintenance personnel to procedures which require special attention, to those which could damage equipment, and to those which could be dangerous to personnel:

NOTE

Instructions to aid in installation, operation, and maintenance or which clarify a procedure.

CAUTION

Instructions which must be followed to avoid causing damage to the product or other equipment incidental to the installation. These instructions describe the requirements and the possible damage which could result from failure to follow the procedures.

WARNING

```

////////////////////////////////////
//
// These instructions must be followed to avoid causing in- //
// jury or death to personnel, and describe the procedure //
// required and the injury which could result from failure //
// to follow the procedure. //
// //
////////////////////////////////////

```

WARNINGS

WARNINGS - SECTION A

THESE WARNINGS APPLY TO 80 SERIES BASIC PUMPS. GORMAN-RUPP HAS NO CONTROL OVER OR PARTICULAR KNOWLEDGE OF THE POWER SOURCE WHICH WILL BE USED. REFER TO THE MANUAL ACCOMPANYING THE POWER SOURCE BEFORE ATTEMPTING TO BEGIN OPERATION.

WARNING

Before attempting to open or service the pump:
1. Familiarize yourself with this manual.
2. Disconnect the power source to ensure that the pump will remain inoperative.
3. Allow the pump to cool if overheated.
4. Vent the pump slowly and cautiously.
5. Close the suction and discharge valves.
6. Check the temperature before opening any covers, plates, or plugs.
7. Drain the pump.

WARNING

This pump is designed to pump materials which could cause serious illness or injury through direct exposure or emitted fumes. Wear protective clothing, such as rubber gloves, face mask, and rubber apron, as necessary before disassembling the pump or piping.

WARNING

This pump is designed to pump liquids containing non-abrasive chemicals of the type and concentration indicated on the application chart (Page A-3). Do not attempt to pump any solutions which has not been specified, or liquids which may damage the pump or endanger personnel as a result of pump failure.

WARNING

After the pump has been installed, make certain that the pump and all piping connections are secure before attempting to operate the pump.

WARNINGS

WARNING

```

////////////////////////////////////
//
// Do not operate the pump without a guard over the rotat- //
// ing parts. Exposed rotating parts can catch clothing, //
// fingers, or tools, causing severe injury to personnel. //
//
////////////////////////////////////

```

WARNING

```

////////////////////////////////////
//
// Do not operate the pump against a closed discharge valve //
// for long periods of time. This could bring the liquid //
// to a boil, build pressure, and cause the pump to rupture //
// or explode.
//
////////////////////////////////////

```

WARNING

```

////////////////////////////////////
//
// Overheated pumps can cause severe burns and injury. If //
// overheating of the pump occurs:
//
// 1. Stop the pump immediately.
// 2. Allow the pump to cool.
// 3. Refer to instructions in this manual before re- //
// starting the pump.
//
////////////////////////////////////

```

WARNING

```

////////////////////////////////////
//
// Do not remove plates, covers, gauges, pipe plugs, or //
// fittings from an overheated pump. Vapor pressure within //
// the pump can cause parts being disengaged to be ejected //
// with great force. Allow the pump to cool before servic- //
// ing.
//
////////////////////////////////////

```

WARNINGS

COMPATABILITY APPLICATION RECOMMENDATION CHART

The wetted portions of this pump are constructed of fiberglass-reinforced thermosetting polyester and type 316 stainless steel. It incorporates a mechanical self-lubricating shaft seal with ceramic and carbide faces. The pump will safely handle non-abrasive chemicals and solutions, at the recommended concentrations and within a 0° to 160°F temperature range, as specified in the following chart.

The application compatibility shown on the following chart can be further affected by dynamic and static product pressures and by hydrostatic shock pressure.

This pump is keyed as R = RECOMMENDED and N S = NOT SUITABLE for the liquids and concentrations listed. Concentrations are keyed as < = LESS THAN and > = GREATER THAN.

WARNING

```

////////////////////////////////////
// DO NOT apply this pump on liquids which have not been //
// listed as compatible on the Compatibility Application //
// Recommendation Chart, or at temperatures beyond 0° to //
// 160°F, or at other than specified concentrations. Oper- //
// ating this pump in any other manner could damage it, and //
// cause the pump to rupture and release corrosive chemi- //
// cals and/or fumes. //
// //
////////////////////////////////////
    
```

LIQUID PUMPED AND CONCENTRATION	APPLICATION	LIQUID PUMPED AND CONCENTRATION	APP
Acetic Acid	<50%	N S	N S
Acetic Anhydride		N S	N S
Acetone		N S	N S
Acetonitrile		N S	N S
Aluminum Fluoride		N S	N S
Aluminum Hydroxide		N S	N S
Aluminum Nitrate	10%	N S	N S
Ammonia, Aqueous	<30%	N S	R
Ammonium Benzoate		N S	N S
Ammonium Bicarbonate	10-50%	R	R
Ammonium Carbonate		R	R
Ammonium Chloride		R	R
Ammonium Citrate		N S	N S
Ammonium Fluosilicate		N S	N S
Ammonium Hydroxide		N S	N S
Ammonium Nitrate		N S	R
Ammonium Persulfate		R	N S
Ammonium Phosphate		R	R
Ammonium Sulfate	>20%	R	R
Ammonium Thiocyanate	20-50%	R	R
Amyl Acetate		N S	R
Amyl Alcohol		R	R
		Amyl Chloride	N S
		Aniline	N S
		Aniline Sulfate	N S
		Aqua Regia	N S
		Arsenic Acid	80% R
		Arsenious Acid	15% N S
		Barium Acetate	N S
		Barium Chloride	R
		Barium Sulfate	N S
		Barium Sulfide	R
		Beer	R
		Beet Sugar Liquor	R
		Benzaldehyde	N S
		Benzene	N S
		Benzene Sulfonic Acid	0-75% N S
		Benzoic Acid	R
		Benzoquinones	N S
		Benzyl Alcohol	R
		Black Liquor	R
		Blood	R
		Borax	R
		Boric Acid	R

WARNINGS

LIQUID PUMPED AND CONCENTRATION	APPLICATION	LIQUID PUMPED AND CONCENTRATION	APP
Brine (NaCl & CaCl)	R	Green Liquor	N S
Bromine	N S	Hydrocyanic Acid	10% R
Butyl Acetate	N S	Hydrofluoric Acid	N S
Butyl Alcohol	R	Hydrogen Peroxide	3-30% N S
Butyric Acid	50% N S	Hydrogen Sulfide	R
Cadmium Chloride	N S	Kerosene	R
Calcium Chlorite	R	Lead Acetate (Sugar of Lead)	N S
Calcium Hydroxide	N S	Linseed Oil	R
Calcium Sulfate	N S	Magnesium Sulfate	R
Cane Juice, Liquor & Sweetwater	R	Methyl Chloride	R
Caprylic Acid	R	Milk	R
Carbon Dioxide	R	Naphtha	R
Carbon Disulfide	N S	Nickel Chloride	R
Carbon Tetrachloride	N S	Nickel Nitrate	N S
Caustic Potash	N S	Nickel Sulfate	N S
Chloroacetic Acid	100% N S	Nitric Acid	5% R
Chlorobenzene	R	Nitric Acid	>10% N S
Chloroform	N S	Nitrobenzene	N S
Chlorosulfonic Acid	N S	Oleic Acid	N S
Chrome Plating Solution	Consult G-R	Oleum	N S
Chromium Sulfate	N S	Perchloric Acid	>25% N S
Citric Acid	R	Phenol	N S
Coconut Oil	R	Phosphoric Acid	10-85% N S
Copper Chloride	N S	Phthalic Anhydride	N S
Copper Cyanide	R	Picric Acid (Alc soln.)	10% N S
Copper Nitrate	R	Potassium Bicarbonate	10% N S
Copper Sulfate (Blue Vitriol)	R	Potassium Carbonate	N S
Corn Oil	R	Potassium Chloride	R
Corn Starch Slurry	N S	Potassium Dichromate	R
Cottonseed Oil	R	Potassium Ferrocyanide	R
Cresylic Acid	N S	Potassium Hydroxide	N S
Crude Oil	R	Potassium Nitrate	N S
Detergents Sulfonated	N S	Potassium Permanganate	N S
Dimethyl Phthalate	N S	Potassium Persulfate	R
Dimethyl Sulfoxide	N S	Potassium Sulfate	R
Dioctyl Phthalate	N S	Silver Nitrate	N S
Ethyl Acetate	N S	Sodium Acetate	R
Ethyl Alcohol (Ethanol)	R	Sodium Bicarbonate	10% N S
Ethyl Ether	N S	Sodium Bisulfite	N S
Ethylene Chloride	N S	Sodium Bromide	N S
Ethylene Chloroformate	N S	Sodium Carbonate	N S
Ethylene Dichloride	N S	Sodium Chloride	N S
Ethylene Glycol	R	Sodium Cyanide	N S
Fatty Acids	R	Sodium Ferricyanide	R
Ferric Nitrate	R	Sodium Hydroxide	N S
Ferric Sulfate	R	Sodium Hypochlorite	5% N S
Ferrous Sulfate	R	Sodium Hypochlorite	>10% N S
Formaldehyde	10-40% R	Sodium Nitrate	N S
Formic Acid	N S	Sodium Nitrite	N S
Fruit Acid	R	Sodium Sulfate	R
Gasoline	R	Stannous Chloride	N S
Gluconic Acid	50% N S	Stearic Acid	R

LIQUID PUMPED AND CONCENTRATION	APPLICATION		LIQUID PUMPED AND CONCENTRATION	APP
Sulfur Dioxide		R	Trichloromonofluoromethane	N S
Sulfuric Acid	10%	N S	Urea-Ammonia Nitrate Fert.	N S
Sulfuric Acid	>75%	N S	8-8-8 Fertilizer	N S
Tannic Acid		R	Water, potable city	R
Tartaric Acid		R	Water, de-ionized	R
Trichloroacetic Acid	50%	N S	Water, distilled	R
Trichloroethylene		N S	Water, well	R
Tetrachloroethylene		N S	Xylene (Xylol)	N S
Toluene		N S	Zinc Nitrate	R
Trisodium Phosphate		N S	Zinc Sulfate	R

INSTALLATION - SECTION B

Since pump installations are seldom identical, this section offers only general recommendations and practices required to inspect, position, and arrange the pump and piping.

Most of the information pertains to a standard **static lift application** where the pump is positioned above the free level of liquid to be pumped.

If installed in a **flooded suction application** where the liquid is supplied to the pump under pressure, some of the information such as mounting, line configuration, and priming must be tailored to the specific application. Since the pressure supplied to the pump is critical to performance and safety, **be sure** to limit the incoming pressure to 50% of the maximum pressure developed by the pump. (See Section E, Page 1.) If the pump is fitted with a Gorman-Rupp double grease lubricated seal, the maximum incoming pressure must be reduced to 10 p.s.i..

For further assistance, contact your Gorman-Rupp distributor or the Gorman-Rupp Company.

Pump Dimensions

See Figure 1 for the approximate physical dimensions of this pump.

OUTLINE DRAWING

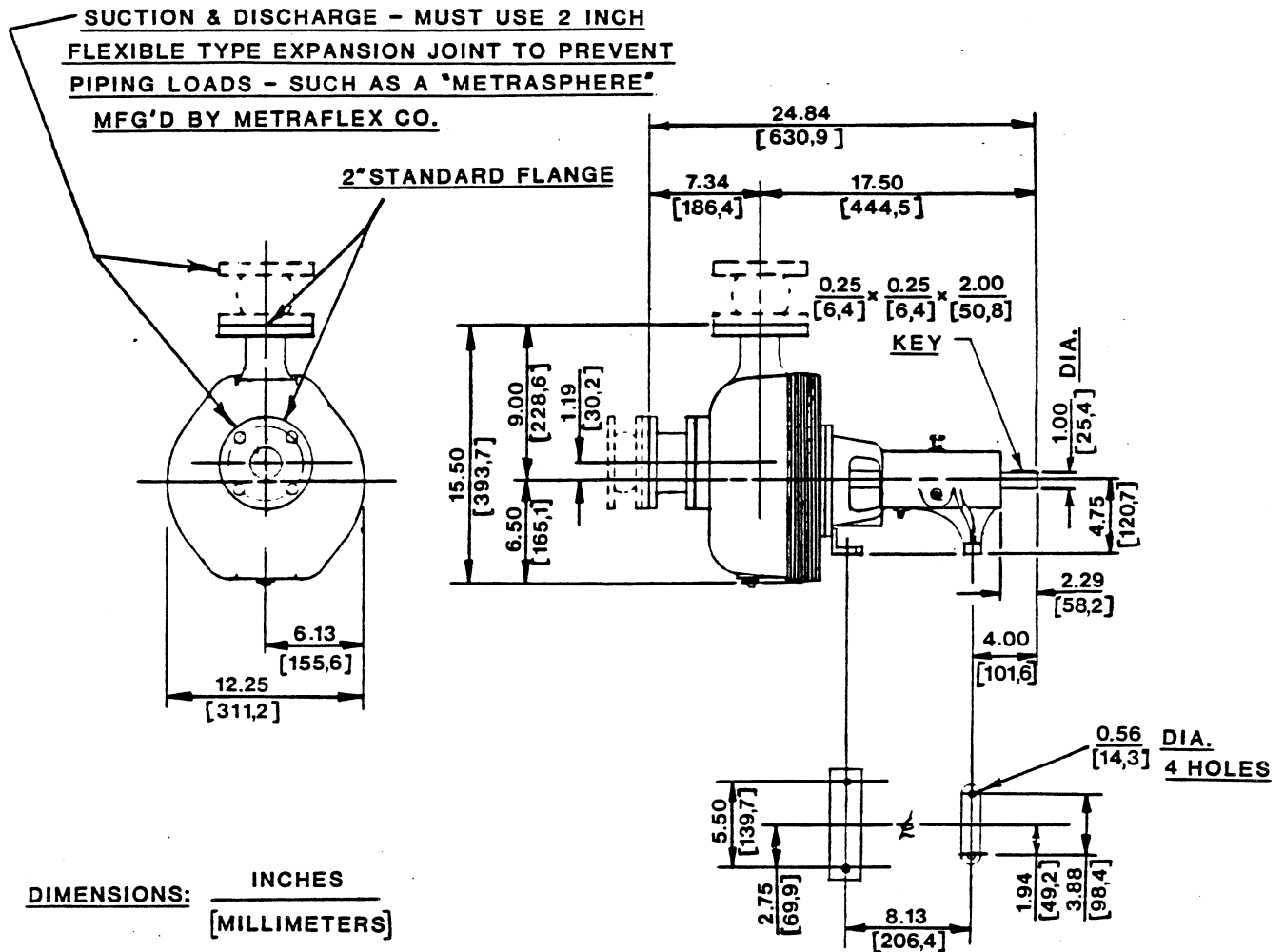

Figure 1. Pump Model 82E49-B

PREINSTALLATION INSPECTION

The pump assembly was inspected and tested before shipment from the factory. Before installation, inspect the pump for damage which may have occurred during shipment. Check as follows:

- Inspect the pump assembly for cracks, dents, damaged threads, and other obvious damage.
- Check for and tighten loose bolts, nuts, capscrews, and other attaching hardware. Since gaskets tend to shrink after drying, check for and tighten loose nuts and capscrews securing mating surfaces.
- Carefully read all tags, decals, and markings on the pump assembly, and perform all duties indicated. Note the direction of rotation indicated

on the pump. Check that the pump shaft rotates in the required direction.

CAUTION

Only operate this pump in the direction indicated by the arrow on the pump body and on the accompanying decal. Otherwise, the impeller could become loosened from the shaft and seriously damage the pump.

- d. Check all lubricant levels and lubricate as necessary. Refer to LUBRICATION in the MAINTENANCE AND REPAIR section of this manual and perform duties as instructed.
- e. If the pump and power source have been stored for more than 12 months, some of the components or lubricants may have exceeded their maximum shelf life. These **must be inspected or replaced** to ensure maximum pump service.
- f. Check to ensure the impeller removal tool (P/N 48731-006) has been shipped with the pump assembly.

If the maximum shelf life has been exceeded, or if anything appears to be abnormal, contact your Gorman-Rupp distributor or the factory to determine the repair or updating policy. **Do not** put the pump into service until appropriate action has been taken.

POSITIONING PUMP

Lifting

Use lifting equipment with a capacity of a least **300 pounds**. This pump weighs approximately **60 pounds**, not including the weight of accessories and base.

CAUTION

The pump assembly can be seriously damaged if the cables or chains used to lift and move the unit are improperly wrapped around the pump.

CAUTION

The pump casing, flanges, and seal plate are made of glass-reinforced polyester which can crack under impact or shock. Take every precaution against dropping the pump or striking plastic parts.

Mounting

Locate the pump in an accessible place as close as practical to the liquid being pumped. Level mounting is essential for proper operation. The pump may have to be supported or shimmed to provide for level operation or to eliminate vibration.

Recommended Pump Installation

Figure 2 shows a typical installation recommended for this pump.

Anchor the pump assembly securely to the base (A), or to the floor, to prevent movement of the pump.

Remove the 1/2-inch NPT drain plug from the bottom of the pump casing, and install a 1/4-inch pipe (minimum) or 3/8-inch I.D. drain line from the pump casing to the sump or drain. Install a manual shutoff valve (B) in the line to drain the pump prior to any maintenance or repair. Support the drain line.

Install a flexible pipe connector (C) at the pump suction flange, and install a full vacuum type line. A flexible connector may also be fabricated from a full vacuum type hose as an alternative. In either case, make certain that the material content of the flexible connector is compatible with the liquid being pumped.

Use pipe hangers (D) to support both suction and discharge piping, and to prevent piping loads from being transferred to the flexible pipe connectors or to the pump casing. The reinforced plastic body of the pump is strong but brittle, and bending loads combined with vibration from normal operation can cause fatigue or cracking of the piping or pump casing.

Install a 4-way piping cross (E) on the pump discharge flange (F) to facilitate priming, and install a blind flange (G) at the top of the cross. Remove this flange to fill the pump casing, and replace it before starting the pump.

WARNING

```

////////////////////////////////////
//
// Replace and secure the blind flange at the top of the //
// piping cross before starting the pump. If the flange is //
// not securely tightened, caustic or hazardous liquid //
// could be forcibly discharged when the pump is operating, //
// and personnel could be injured. //
//
////////////////////////////////////
    
```

A permanent priming line (H), fitted with a suitable shutoff valve (J) and a wall-mounted priming reservoir (K), is recommended for installations where the pump must be primed with caustic or hazardous liquids.

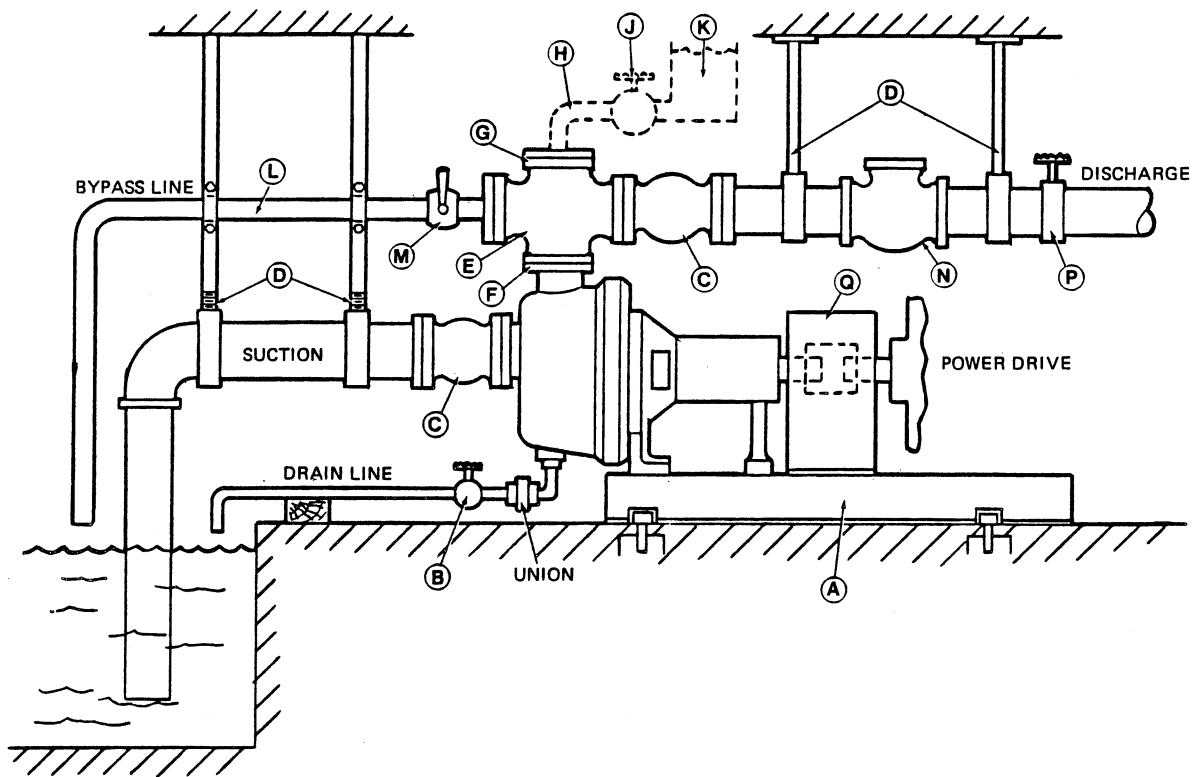

Figure 2. Typical Recommended Installation, Pump 82E49-B

SUCTION AND DISCHARGE PIPING

Materials

Either pipe or hose may be used for suction and discharge lines. Piping materials must be compatible with the liquid being pumped. If hose is used in suction

lines, it must be the rigid-wall, reinforced type to prevent collapse under suction. Using piping couplings in suction lines is not recommended.

Line Configuration

Keep suction and discharge lines as straight as possible to minimize friction losses. Make minimum use of elbows and fittings, which substantially increase friction loss. If elbows are necessary, use the long-radius type to minimize friction loss.

Flexible connectors are required on all suction and discharge connections in order to prevent piping loads.

CAUTION

In order to prevent piping loads, flexible connectors must be used on all suction and discharge connections. IF FLEXIBLE CONNECTORS ARE NOT USED, THE PUMP WARRANTY WILL BE VOIDED.

Connections to Pump

Before tightening a connecting flange, align it exactly with the pump port. Never pull a pipe line into place by tightening the flange bolts and/or couplings.

Lines near the pump must be independently supported to avoid strain on the pump which could cause excessive vibration, decreased bearing life, and increased shaft and seal wear. If hose-type lines are used, they should have adequate support to secure them when filled with liquid and under pressure.

Gauges

Most pumps are drilled and tapped for installing discharge pressure and vacuum suction gauges. If these gauges are desired for pumps that are not tapped, drill and tap the suction and discharge lines close to the pump before installing the lines.

SUCTION LINES

To avoid air pockets which could affect pump priming, the suction line must be as short and direct as possible. When operation involves a suction lift, the line must always slope upward to the pump from the source of the liquid being pumped; if the line slopes down to the pump at any point along the suction run, air pockets will be created.

Fittings

Suction lines should be the same size as the pump inlet. If reducers are used in suction lines, they should be the eccentric type, and should be installed with the flat part of the reducers uppermost to avoid creating air pockets. Valves are not normally used in suction lines, but if a valve is used, install it with the stem horizontal to avoid air pockets.

Strainers

If a strainer is furnished with the pump, be certain to use it; any spherical solids which pass through a strainer furnished with the pump will also pass through the pump itself.

If a strainer is not furnished with the pump, but is installed by the pump user, make certain that the total area of the openings in the strainer is at least three or four times the cross section of the suction line, and that the openings will not permit passage of solids larger than the solids handling capability of the pump.

This pump is designed to handle up to 3/4 inch diameter spherical solids.

Sealing

Since even a slight leak will affect priming, head, and capacity, especially when operating with a high suction lift, all connections in the suction line should be sealed with pipe dope to ensure an airtight seal. Follow the sealant manufacturer's recommendations when selecting and applying the pipe dope. The pipe dope should be compatible with the liquid being pumped.

Suction Lines In Sumps

If a single suction line is installed in a sump, it should be positioned away from the wall of the sump at a distance equal to one and one-half times the diameter of the suction line.

If there is a liquid flow from an open pipe into the sump, the flow should be kept away from the suction inlet because the inflow will carry air down into the sump, and air entering the suction line will reduce pump efficiency.

If it is necessary to position inflow close to the suction inlet, install a baffle between the inflow and the suction inlet at a distance one and one-half times the diameter of the suction pipe. The baffle will allow entrained air to escape from the liquid before it is drawn into the suction inlet.

If two suction lines are installed in a single sump, the flow paths may interact, reducing the efficiency of one or both pumps. To avoid this, position the suction inlets so that they are separated by a distance equal to at least three times the diameter of the suction pipe.

Suction Line Positioning

The depth of submergence of the suction line is critical to efficient pump operation. Figure 3 shows recommended minimum submergence vs. velocity.

NOTE

The pipe submergence required may be reduced by installing a standard pipe increaser fitting at the end of the suction line. The larger opening size will reduce the inlet velocity. Calculate the required submergence using the following formula based on the increased opening size (area or diameter).

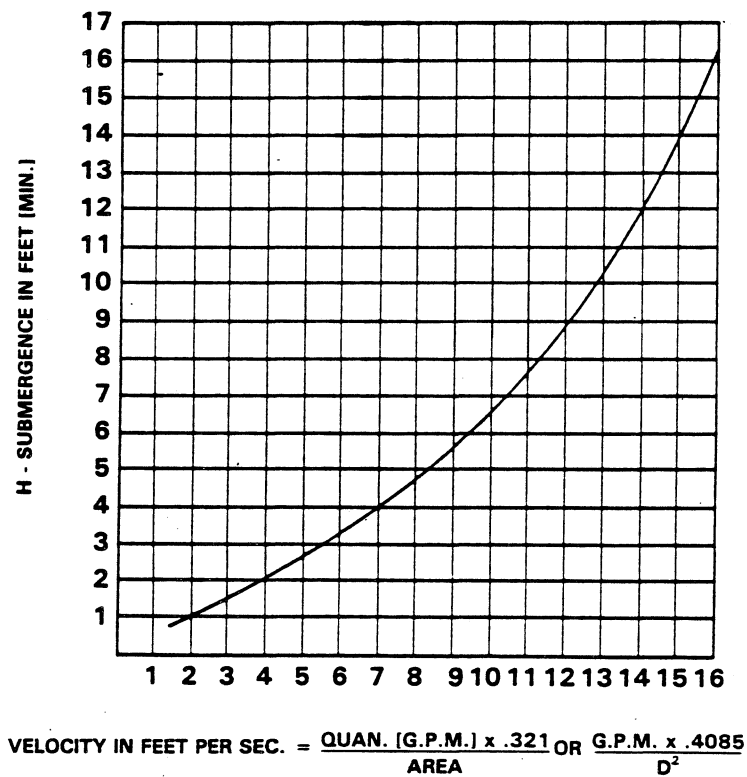

Figure 3. Recommended Minimum Suction Line Submergence Vs. Velocity

DISCHARGE LINES

Siphoning

Do not terminate the discharge line at a level lower than that of the liquid being pumped unless a siphon breaker is used in the line. Otherwise, a siphoning action causing damage to the pump could result.

INSTALLATION

Valves

If a throttling valve is desired in the discharge line, use a valve as large as the largest pipe in the line to minimize friction losses. Never install a throttling valve in a suction line.

A check valve in the discharge line is normally recommended, but is not necessary in low discharge head applications.

With high discharge heads, it is recommended that a throttling valve and a check valve be installed in the discharge line to protect the pump from excessive shock pressure and reverse rotation when it is stopped.

Bypass Lines

(See Figure 2)

In a system with an existing static discharge head, it is recommended that a bypass line (L) be installed to permit the escape of air to atmosphere during initial priming and in the repriming cycle. This bypass line should be sized at 1/2-inch or 3/4-inch, and fitted with a hand-operated shutoff valve (M).

NOTE

This bypass line may clog frequently, particularly if the shut-off valve remains closed for long periods of time. If this condition occurs, either install a larger bypass line or leave the shutoff valve open slightly during the pumping operation.

Install a flexible pipe connector (C) on the discharge side of the piping cross (E).

The installation of a discharge check valve (N) and a manual shutoff valve (P) in the discharge piping is also recommended in systems with existing static discharge heads. The check valve will close off the static discharge head during priming when the bypass shutoff valve is open, and it will open after priming has been accomplished and the bypass shutoff valve is closed. The manual shutoff valve in the discharge line is intended to be used to close off system pressure when the check valve or pump are being serviced.

CAUTION

Close the manual shut-off valve (P) in the discharge line to completely isolate the system before any maintenance, service, or repair on the pump or discharge check valve.

WARNING

```

////////////////////////////////////
//
// When operating this pump, make certain that the dis- //
// charge throttling valve is open. If this pump is oper- //
// ated against a closed discharge throttling valve, pump //
// components will deteriorate, and the liquid could come //
// to a boil, build pressure, and cause the pump to //
// rupture. //
// //
////////////////////////////////////

```

Do not terminate the discharge line at a level lower than that of the liquid being pumped unless a siphon breaker is used in the line. Otherwise, a siphoning action could result, causing damage to the pump.

ALIGNMENT

The alignment of the pump and its power source is critical for trouble-free mechanical operation. In either a flexible coupling or V-belt driven system, the driver and pump must be mounted so that their shafts are aligned with and parallel to each other. It is imperative that alignment be checked after the pump is installed, and before operation.

NOTE

Check **Rotation**, Section C, before final alignment of the pump.

When mounted at the Gorman-Rupp factory, driver and pump are aligned before shipment. Misalignment can occur in transit and handling. Pumps should be checked, and realigned if necessary, before being put into operation. Before checking alignment, tighten the foundation bolts. The pump casing feet and/or pedestal feet, and the driver mounting bolts should also be tightly secured.

WARNING

```

////////////////////////////////////
//
// When checking alignment, disconnect the power source to //
// ensure that the pump will remain inoperative. //
// //
////////////////////////////////////

```

CAUTION

<p>Adjusting the alignment in one direction may alter the alignment in another direction. Check each procedure after altering alignment.</p>
--

INSTALLATION

Coupled Drives

When using couplings, the axis of the power source must be aligned to the axis of the pump shaft in both the horizontal and vertical planes. Most couplings require a specific gap or clearance between the driving and the driven shafts. Refer to the coupling manufacturer's service literature.

Align spider insert type couplings by using calipers to measure the dimensions on the circumference of the outer ends of the coupling hub every 90 degrees. The coupling is in alignment when the hub ends are the same distance apart at all points (see Figure 4a).

Align non-spider type couplings by using a feeler gauge or taper gauge between the coupling halves every 90 degrees. The coupling is in alignment when the hubs are the same distance apart at all points (see Figure 4b).

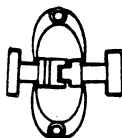

Figure 4a. Aligning Spider-Type Couplings

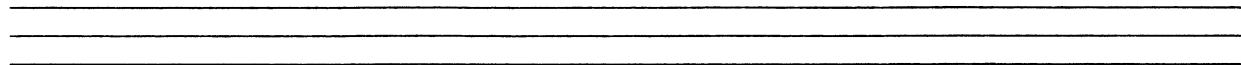

Figure 4b. Aligning Non-Spider Type Couplings

Check parallel adjustment by laying a straightedge across both coupling rims at the top, bottom, and side. When the straightedge rests evenly on both halves of the coupling, the coupling is in horizontal parallel alignment. If the coupling is misaligned, use a feeler gauge between the coupling and the straightedge to measure the amount of misalignment.

V-Belt Drives

When using V-belt drives, the power source and the pump must be parallel. Use a straightedge along the sides of the pulleys to ensure that the pulleys are properly aligned (see Figure 4c). In drive systems using two or more belts, make certain that the belts are a matched set; unmatched sets will cause accelerated belt wear.



MISALIGNED: SHAFTS NOT PARALLEL



MISALIGNED: SHEAVES NOT IN LINE



ALIGNED: SHAFTS PARALLEL AND SHEAVES IN LINE

Figure 4c. Alignment of V-Belt Driven Pumps

Tighten the belts in accordance with the belt manufacturer's instructions. If the belts are too loose, they will slip; if the belts are too tight, there will be excessive power loss and possible bearing failure. Select pulleys that will match the proper speed ratio; overspeeding the pump may damage both pump and power source.

WARNING

```

////////////////////////////////////
// Do not operate the pump without a guard over the rotat- //
// ing parts. Exposed rotating parts can catch clothing, //
// fingers, or tools, causing severe injury to personnel. //
// //
////////////////////////////////////

```

OPERATION

OPERATION - SECTION C

WARNING

```

////////////////////////////////////
//
// Before attempting to open or service the pump:
//
// 1. Familiarize yourself with this manual.
// 2. Disconnect the power source to ensure that the
// pump will remain inoperative.
// 3. Allow the pump to cool if overheated.
// 4. Vent the pump slowly and cautiously.
// 5. Close the suction and discharge valves.
// 6. Check the temperature before opening any covers,
// plates, or plugs.
// 7. Drain the pump.
//
////////////////////////////////////

```

WARNING

```

////////////////////////////////////
//
// DO NOT apply this pump on liquids which have not been
// listed as compatible on the Compatibility Application
// Recommendation Chart, or at temperatures beyond 0° to
// 160°F, or at other than specified concentrations. Oper-
// ating this pump in any other manner could damage it, and
// cause the pump to rupture and release corrosive chemi-
// cals and/or fumes.
//
////////////////////////////////////

```

PRIMING

Install the pump and piping as described in INSTALLATION. Make sure that the piping connections are tight, and that the pump is securely mounted. Check that the pump is properly lubricated (see LUBRICATION in MAINTENANCE AND REPAIR).

This pump should never be operated unless there is liquid in the casing.

CAUTION

Never operate this pump unless there is liquid in the casing. The pump will not prime when dry. Extended operation of a dry pump will destroy the seal assembly.

Add liquid to the pump casing when:

1. The pump is being put into service for the first time.
2. The pump has not been used for a considerable length of time.

3. The liquid in the pump casing has evaporated.

WARNING

```

////////////////////////////////////
//
// After filling the pump casing, reinstall and tighten the //
// fill plug. Do not attempt to operate the pump unless //
// all connecting piping is securely installed. Otherwise, //
// liquid in the pump forced out under pressure could cause //
// injury to personnel. //
// //
////////////////////////////////////

```

STARTING

Consult the operations manual furnished with the power source.

Rotation

The correct direction of pump rotation is clockwise when viewed from the drive end. If the pump is operated in the wrong direction, the impeller could become loosened from the shaft and seriously damage the pump.

CAUTION

Be sure the pump is operated in the correct direction. Otherwise, the impeller could become loosened from the shaft and seriously damage the pump.

Consult the operating manual furnished with the power source before attempting to start the power source.

OPERATION

Lines With a Bypass

A hand operated shutoff valve may be installed in a bypass line.

If a hand operated shutoff valve has been installed, close the throttling valve in the discharge line, and open the bypass shutoff valve so that the pump will not have to prime against the weight of the liquid in the discharge line. When the pump has been primed, and liquid is flowing steadily from the bypass line, close the bypass shutoff valve and open the discharge throttling valve.

OPERATION

Lines Without a Bypass

Open all valves in the discharge line and start the power source. Priming is indicated by a positive reading on the discharge pressure gauge or by a quieter operation. The pump may not prime immediately because the suction line must first fill with liquid. If the pump fails to prime within five minutes, stop it and check the suction line for leaks.

After the pump has been primed, partially close the discharge line throttling valve in order to fill the line slowly and guard against excessive shock pressure which could damage pipe ends, gaskets, sprinkler heads, and any other fixtures connected to the line. When the discharge line is completely filled, adjust the throttling valve to the required flow rate.

Leakage

No leakage should be visible at pump mating surfaces, or at pump connections or fittings. Keep all line connections and fittings tight to maintain maximum pump efficiency.

Liquid Temperature And Overheating

The maximum liquid temperature for this pump is 160°F, or as dictated by the chemical characteristics. Do not apply it at a higher operating temperature.

Overheating can occur if the valves in the suction or discharge lines are closed. Operating against closed valves could bring the liquid to a boil, build pressure, and cause the pump to rupture or explode. If overheating occurs, stop the pump and allow it to cool before servicing it. Refill the pump casing with cool liquid.

WARNING

////////////////////////////////////
//
// Do not remove plates, covers, gauges, pipe plugs, or //
// fittings from an overheated pump. Vapor pressure within //
// the pump can cause parts being disengaged to be ejected //
// with great force. Allow the pump to cool before servic- //
// ing. //
//
////////////////////////////////////

Strainer Check

If a suction strainer has been shipped with the pump or installed by the user, check the strainer regularly, and clean it as necessary. The strainer should also be checked if pump flow rate begins to drop.

Pump Vacuum Check

With the pump inoperative, install a vacuum gauge in the system, using pipe dope on the threads. Block the suction line and start the pump. At operating speed the pump should pull a vacuum of 20 inches or more of mercury. If it does not, check for air leaks in the seal, gasket, or discharge valve.

Open the suction line, and read the vacuum gauge with the pump primed and at operation speed. Shut off the pump. The vacuum gauge reading will immediately drop proportionate to static suction lift, and should then stabilize. If the vacuum reading falls off rapidly after stabilization, an air leak exists. Before checking for the source of the leak, check the point of installation of the vacuum gauge.

STOPPING

Never halt the flow of liquid suddenly. If the liquid being pumped is stopped abruptly, damaging shock waves can be transmitted to the pump and piping system. Close all connecting valves slowly.

CAUTION

If application involves a high discharge head, gradually close the discharge throttling valve before stopping the pump.

After stopping the pump, disconnect power source to ensure that the pump will remain inoperative.

Cold Weather Preservation

In below freezing conditions, drain the pump to prevent damage from freezing. Also, clean out any solids by flushing with a hose. Operate the pump for approximately one minute; this will remove any remaining liquid that could freeze the pump rotating parts.

If the pump will be idle for more than a few hours, or if it has been pumping liquids containing a large amount of solids, drain the pump, and flush it thoroughly with clean water. To prevent large solids from clogging the drain port and preventing the pump from completely draining, insert a rod or stiff wire in the drain port, and agitate the liquid during the draining process. Clean out any remaining solids by flushing with a hose.

BEARING TEMPERATURE CHECK

Bearings normally run at higher than ambient temperatures because of heat generated by friction. Temperatures up to 160°F are considered normal for bearings,

OPERATION

and they can operate safely to at least 180°F.

Checking bearing temperatures by hand is inaccurate. Bearing temperatures can be measured accurately by placing a contact-type thermometer against the housing. Record this temperature for future reference.

A sudden increase in bearing temperatures is a warning that the bearings are at the point of failing to operate properly. Make certain that the bearing lubricant is of the proper viscosity and at the correct level (see LUBRICATION in MAINTENANCE AND REPAIR). Bearing overheating can also be caused by shaft misalignment and/or excessive vibration.

When pumps are first started, the bearings may seem to run at temperatures above normal. Continued operation should bring the temperatures down to normal levels.

TROUBLESHOOTING - SECTION D

WARNING

```

////////////////////////////////////
//
// Before attempting to open or service the pump:
//
// 1. Familiarize yourself with this manual.
// 2. Disconnect the power source to ensure that the
// pump will remain inoperative.
// 3. Allow the pump to cool if overheated.
// 4. Vent the pump slowly and cautiously.
// 5. Close the suction and discharge valves.
// 6. Check the temperature before opening any covers,
// plates, or plugs.
// 7. Drain the pump.
//
////////////////////////////////////
    
```

TROUBLE	POSSIBLE CAUSE	PROBABLE REMEDY
PUMP FAILS TO PRIME	Air leak in suction line. Lining of suction hose collapsed. Leaking or worn seal or pump gasket. Suction check valve or foot valve clogged or binding. Suction lift or discharge head too high.	Correct leak. Replace suction hose. Check pump vacuum. Replace leaking or worn seal or gasket. Clean valve. Check piping installation and install bypass line if needed. See INSTALLATION.
PUMP STOPS OR FAILS TO DELIVER RATED FLOW OR PRES-SURE	Air leak in suction line. Suction intake not submerged at proper level or sump too small. Lining of suction hose collapsed. Impeller or other wearing parts worn or damaged.	Correct leak. Check installation and correct as needed. Check submergence chart (Section B). Replace suction hose. Replace worn or damaged parts. Check that impeller is properly centered and rotates freely.

TROUBLE	POSSIBLE CAUSE	PROBABLE REMEDY
PUMP STOPS OR FAILS TO DELIVER RATED FLOW OR PRES-SURE(cont.)	<p>Impeller clogged.</p> <p>Pump speed too slow.</p> <p>Discharge head too high.</p> <p>Suction lift too high.</p> <p>Leaking or worn seal or pump gasket.</p>	<p>Free impeller of debris.</p> <p>Check driver output; check belts or couplings for slippage.</p> <p>Install bypass line.</p> <p>Reduce suction lift.</p> <p>Check pump vacuum. Replace leaking or worn seal or gasket.</p>
PUMP REQUIRES TOO MUCH POWER	<p>Pump speed too high.</p> <p>Discharge head too low.</p> <p>Liquid solution too thick.</p>	<p>Check driver output; check that sheaves or couplings are correctly sized.</p> <p>Adjust discharge valve.</p> <p>Dilute if possible.</p>
PUMP CLOGS FREQUENTLY	<p>Discharge flow too slow.</p> <p>Suction check valve or foot valve clogged or binding.</p>	<p>Open discharge valve fully to increase flow rate, and run engine at maximum governed speed.</p> <p>Clean valve.</p>
EXCESSIVE NOISE	<p>Cavitation in pump.</p> <p>Pumping entrained air.</p> <p>Pump or drive not securely mounted.</p> <p>Impeller clogged or damaged.</p>	<p>Reduce suction lift and/or friction losses in suction line.</p> <p>Locate and eliminate source of air bubble.</p> <p>Secure mounting hardware.</p> <p>Clean out debris; replace damaged parts.</p>

TROUBLE	POSSIBLE CAUSE	PROBABLE REMEDY
BEARINGS RUN TOO HOT	Bearing temperature is high, but within limits. Low or incorrect lubricant. Suction and discharge lines not properly supported. Drive misaligned.	Check bearing temperature regularly to monitor any increase. Check for proper type and level of lubricant. Check piping installation for proper support. Align drive properly.

MAINTENANCE AND REPAIR - SECTION E

MAINTENANCE AND REPAIR OF THE WEARING PARTS OF THE PUMP WILL MAINTAIN PEAK OPERATING PERFORMANCE.

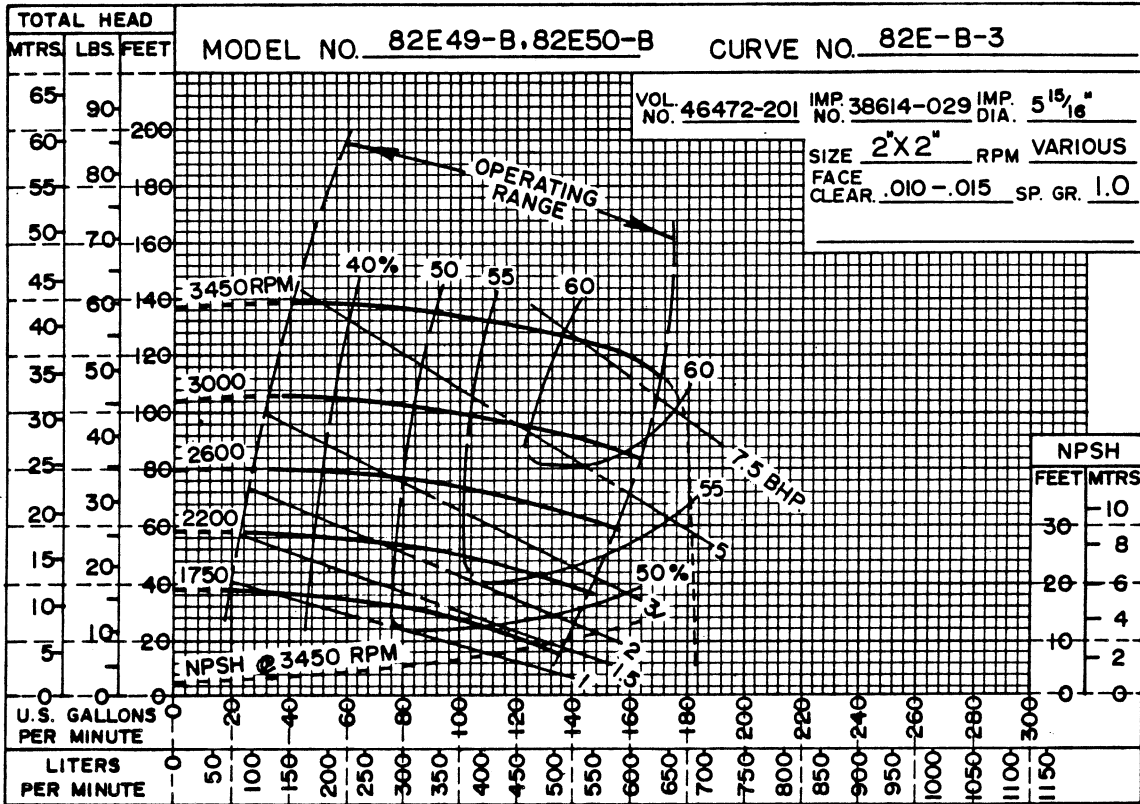

T-II-29-78-R

*STANDARD PERFORMANCE FOR PUMP MODEL 82E49-B

*Based on 70°F clear water at sea level with minimum suction lift. Since pump installations are seldom identical, your performance may be different due to such factors as viscosity, specific gravity, elevation, temperature, and impeller trim.

If your pump serial number is followed by an "N", your pump is NOT a standard production model. Contact the Gorman-Rupp Company to verify performance or part numbers.

SECTIONAL DRAWING

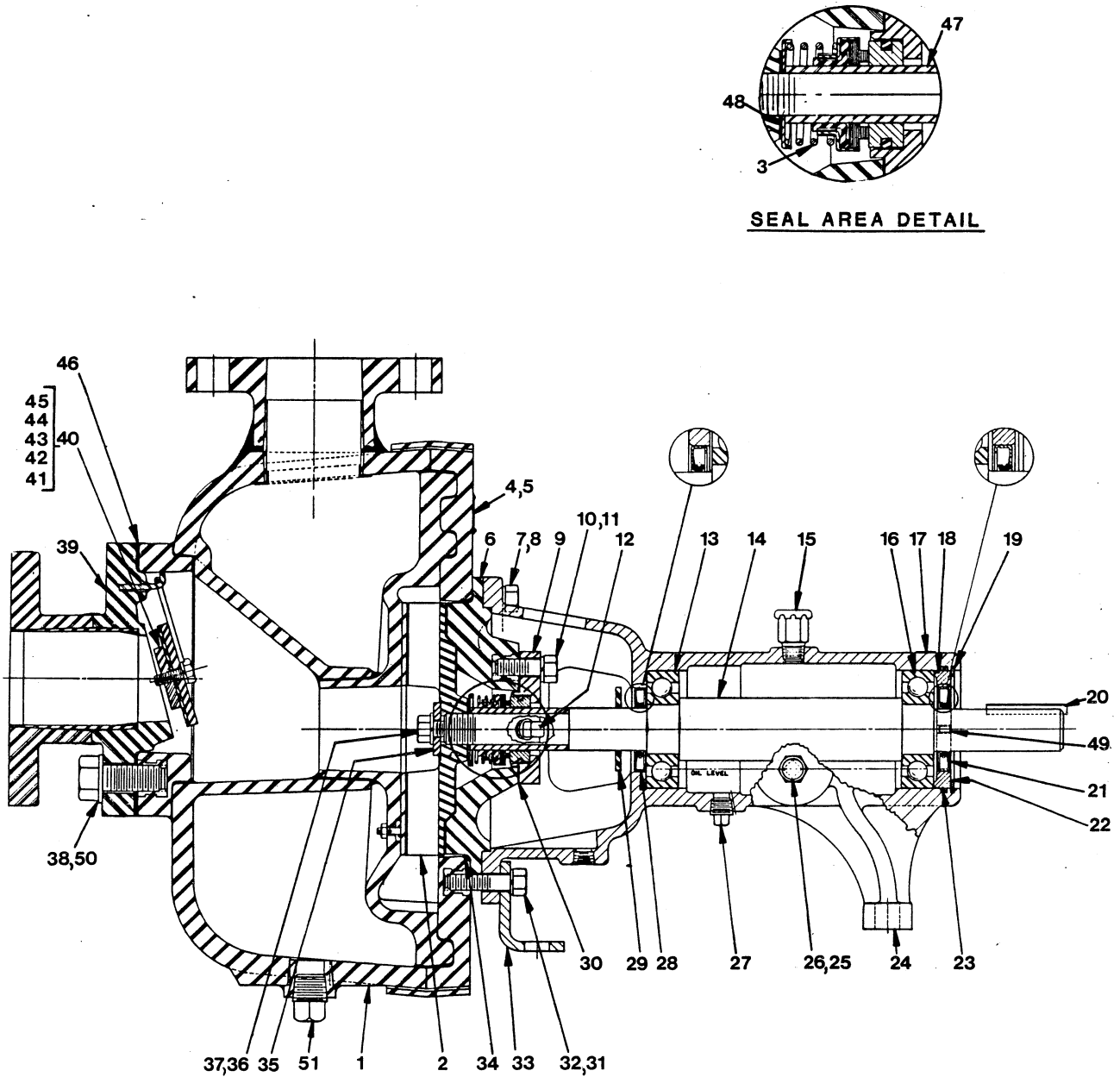

Figure 1. Pump Model Assembly 82E49-B

PARTS LIST
 Pump Model 82E49-B
 (From S/N 778308 up)

ITEM NO.	PART NAME	PART NUMBER	MATL CODE	QTY	ITEM NO.	PART NAME	PART NUMBER	MATL CODE	QTY
1	PUMP CASING ASSY	46472-201	-----	1	28	*OIL SEAL	25227-216	-----	1
2	*IMPELLER	38614-029	23140	1	29	SLINGER RING	2351	19120	1
3	*SEAL ASSY	25271-867	-----	1	30	SEAL CLAMP GSKT	38681-209	19210	1
4	NAME PLATE	2613-CW	13990	1	31	HEX HD CAPSCREW	B00606	17090	2
5	DRIVE SCREW	BM#04-03	15990	2	32	LOCKWASHER	J00006	17090	2
6	SEAL PLATE	38272-227	23140	1	33	FOOT BRACKET	34265-020	15990	1
7	HEX HD CAPSCREW	B00605	17090	4	34	*CASING O-RING	25153-163	-----	1
8	LOCKWASHER	J00006	17090	4	35	*IMP WASHER	3118	17090	1
9	*SEAL CLAMP	38326-429	17070	1	36	*IMP CAPSCREW	B00603	17090	1
10	HEX HD CAPSCREW	B00604	17090	2	37	*IMP LOCKWASHER	J00006	17090	1
11	FLAT WASHER	KB00006	17090	2	38	HEX HD CAPSCREW	B01006	17090	4
12	PIPE PLUG	P00002	17090	1	39	CHECK VALVE	46353-036	24010	1
13	*BALL BEARING	S00390	-----	1		FLANGE ASSY			
14	*IMPELLER SHAFT	38514-210	17130	1	40	CHECK VALVE ASSY	46411-065	-----	1
15	PED AIR VENT	S01703	-----	1	41	*-LG VALVE WEIGHT	44211-002	24170	1
16	*BALL BEARING	S00390	-----	1	42	-LOCKWASHER	J00004	17090	1
17	ROTATION DECAL	2613-CU	00000	1	43	-HEX HD CAPSCREW	B00403	17090	1
18	*BRG RETAINER	38322-517	26000	1	44	*-VALVE WEIGHT	31137-001	17090	1
19	*RETAINING RING	S00219	-----	1	45	*-CHECK VALVE GSKT	38671-411	19410	1
20	SHAFT KEY	N00407	15990	1	46	CHECK VALVE GSKT	38688-007	19410	1
21	*OIL SEAL	25227-216	-----	1	47	*SHAFT SLEEVE	3217	17090	1
22	*BRG SHIM SET	S00464	-----	1	48	*IMP SHIM SET	2-Y	17090	1
23	*BRG RET O-RING	25152-149	-----	1	49	SETSCREW	GA#10-01-S	15990	2
24	PEDESTAL	3212-C	10010	1	50	FLAT WASHER	KB00010	17090	4
25	PIPE PLUG	P00006	11990	1	51	CASING DRAIN PLUG	P00008	17090	1
26	*PED SIGHT GAUGE	26714-011	-----	1		NOT SHOWN:			
27	PED DRAIN PLUG	P00006	11990	1		IMPELLER TOOL	48731-006	-----	1

*INDICATES PARTS RECOMMENDED FOR STOCK

Above Serial Numbers Do Not Apply To Pumps Made In Canada.

CANADIAN SERIAL NO AND UP

PUMP AND SEAL DISASSEMBLY AND REASSEMBLY

This pump requires little service due to its rugged, minimum-maintenance design. However, if it becomes necessary to inspect or replace the wearing parts, follow these instructions which are keyed to the sectional view (see figure 1) and the accompanying parts list.

Before attempting to service the pump, take precautions to ensure that the power source will remain inoperative. Close all connecting valves in the suction and discharge lines.

WARNING

```

////////////////////////////////////
//
// Before attempting to open or service the pump:
//
// 1. Familiarize yourself with this manual.
// 2. Disconnect the power source to ensure that the
// pump will remain inoperative.
// 3. Allow the pump to cool if overheated.
// 4. Vent the pump slowly and cautiously.
// 5. Close the suction and discharge valves.
// 6. Check the temperature before opening any covers,
// plates, or plugs.
// 7. Drain the pump.
//
////////////////////////////////////
    
```

WARNING

```

////////////////////////////////////
//
// This pump is designed to pump materials which could
// cause serious illness or injury through direct exposure
// or emitted fumes. Wear protective clothing, such as
// rubber gloves, face mask, and rubber apron, as necessary
// before disassembling the pump or piping.
//
////////////////////////////////////
    
```

Suction Check Valve Removal

Before servicing the check valve (39), remove the pump casing drain plug (48) and drain pump. Clean and reinstall plug.

Remove the suction piping, and hardware (37 and 50) securing the suction flange (38) to the pump casing. Pull the suction flange and check valve assembly from the suction port. Scrape the old joint sealant (45) from the mating surfaces.

Lift the check valve assembly from the suction flange and separate the check valve (44) and weights (40 and 43) by removing the hardware (41 and 42). Inspect all parts for wear and replace as necessary.

Pump Disassembly

The casing (1) and pedestal (24) must be separated to perform all maintenance and repair. This may be accomplished by removing the suction and discharge piping, or by removing the power source and withdrawing the pedestal. If the piping is to be left in tact, support the pump casing before removing the pedestal. The following instructions are based on removing the piping.

Remove the capscrews (7 and 30) and lockwashers (8 and 31) securing the seal plate (6) and pedestal to the pump casing. Separate the assemblies and remove the pump casing O-ring (33).

Inspect the casing assembly (1), particularly where paint has peeled or hairline cracks have developed. Examine stress areas and cemented joints. Replace the casing assembly if cracked or damaged.

WARNING

```

////////////////////////////////////
//                               //
// Do not attempt to repair a cracked pump casing. The //
// casing is designed to handle hazardous liquids at pres- //
// sures up to 60 psi. The repaired area could rupture, //
// releasing corrosive chemicals and/or toxic fumes. //
//                               //
////////////////////////////////////

```

Inspect the surface of the wear plate which is an integral part of the pump casing assembly. If the wear plate is scored or badly worn, the casing must be replaced as a complete assembly.

To remove the impeller (2), install a lathe dog on the end of the shaft (14) to prevent rotation and remove the impeller retaining hardware (34, 35, and 36). Install the impeller removal tool and use the end of a 1/2-inch drive ratchet extension (see Figure 2) to unscrew the impeller in a counterclockwise direction (when facing the impeller). Use caution when unscrewing the impeller; tension on the seal spring will be released as the impeller is unscrewed.

CAUTION

Do not try to loosen the impeller by striking the wrench, impeller tool, or impeller; this will crack or chip the impeller. If the impeller will not unscrew readily, hold the impeller stationary and strike the lathe dog sharply with a soft faced hammer.

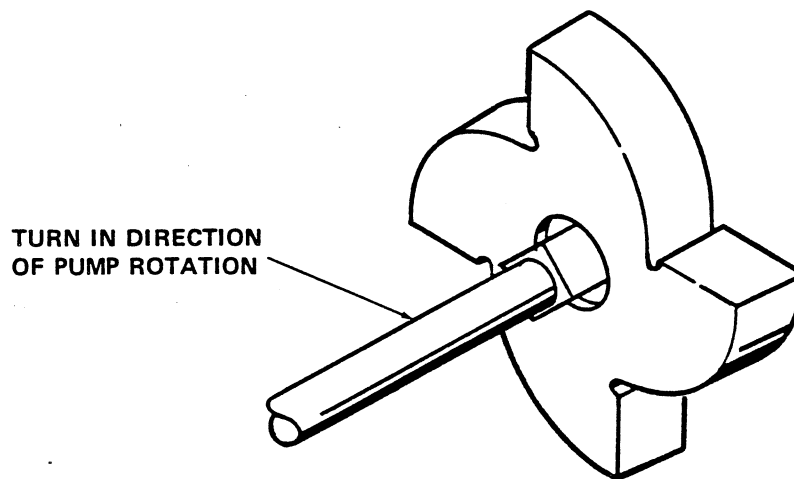

Figure 2. 48731-006 Impeller Tool With Drive Wrench

Inspect the impeller, and replace it if cracked or badly worn. Remove the impeller adjusting shims (47). For ease of reassembly, tag and tie the shims, or measure and record their thickness.

Seal Disassembly

Slide the centering washer off the shaft. Remove the seal assembly (3) as a complete unit by pulling the seal plate (6) along with the seal clamp (9) from the pedestal. To remove the stationary seal seat, seat gasket (30) and O-ring, disengage the hardware (10 and 11) securing the clamp to the seal plate and separate the parts.

Remove the shaft sleeve (48) from the impeller shaft.

If no further disassembly is required, see **Seal Reassembly**.

Impeller Shaft And Bearing Disassembly

When the pump is properly operated and maintained, the pedestal should not require disassembly. Disassemble the shaft and bearings **only** when there is evidence of wear or damage.

CAUTION

Shaft and bearing disassembly in the field is not recommended. These operations should be performed only in a properly-equipped shop by qualified personnel.

Remove the pedestal drain plug (27) to drain the oil from the pedestal. Clean and reinstall drain plug.

Remove the shaft key (20) and the retaining ring (19) from the drive end of the shaft and slide the bearing adjustment shims (22) off. For ease of reassembly, tag and tie the shims, or measure and record their thickness.

Place a block of wood against the impeller end of the shaft and drive the shaft, bearings (13 and 16), and bearing retainer (18) from the pedestal.

NOTE

The bearing retainer (18) can also be removed by replacing the setscrews (49) with two machine screws, and use a gear puller to slide the retainer out of the bore. **Do not** use the machine screws as jacking screws against the bearing.

Remove the bearing retainer O-ring (23). Inspect the oil seal (21) for damage.

Remove the bearings from the shaft with a bearing puller or arbor press. The inboard bearing (13) should come free with the shaft, if it does not, press it out of the pedestal cavity. Remove and inspect the inboard oil seal (28) for damage and replace as necessary.

Impeller Shaft And Bearing Reassembly

Clean the impeller shaft, pedestal cavity and all component parts (except bearings) with a soft cloth soaked in cleaning solvent, and dry thoroughly.

WARNING

```

////////////////////////////////////
//
// Most cleaning solvents are toxic and flammable. Use //
// them only in a well-ventilated area free from excessive //
// heat, sparks, and flame. Read and follow all prec- //
// autions printed on solvent containers. //
// //
////////////////////////////////////
    
```

Inspect the shaft for damaged threads, distortion, or nicks and scratches on the oil seal seating surfaces. Dress small nicks and burrs with a fine file or honing stone. Replace the impeller shaft if defective.

To prevent contamination, wash the bearings separately in **fresh** cleaning solvent. Dry the bearings with filtered compressed air and coat with light oil.

Rotate the bearings by hand to check for roughness or binding, and inspect the bearing balls. If rotation is rough or the balls discolored, replace the bearings.

CAUTION

Bearings must be kept free of all dirt and foreign material. Failure to do so will greatly shorten bearing life. DO NOT spin dry bearings. This may scratch the rollers or races and cause premature bearing failure.

The bearing tolerances provide a light press fit onto the impeller shaft, and a snug push fit into the pedestal. If the bearings slip on and off easily, the shaft is worn and must be replaced. The pedestal must be replaced if the bearings do not fit snugly.

Inspect the pedestal for cracks, especially around the mounting flange and at the foot. Remove nicks and burrs from the bearing seating surfaces with extra fine emery cloth or a fine stone.

Position the lip of the inboard oil seal (28) as shown in Figure 1 and press it into the pedestal bore.

Dip the bearings in clean oil and position them on the shaft. Using an arbor press, press against the inner races until the bearings seat squarely against the shaft shoulders.

NOTE

When installing the bearings onto the shaft, **never** press or hit against the outer race, balls, or ball cage. Press **only** on the inner race.

Push the shaft and assembled bearings into the pedestal until the inboard bearing bottoms against the pedestal cavity. Be careful to avoid damaging the oil seal already installed.

NOTE

When installing the shaft and bearings into the pedestal, push against the outer race. **Never** hit the balls or ball cage.

Install a new O-ring (23) in the drive end of the pedestal.

NOTE

Coat the O-ring with a light coating of petroleum jelly or light oil to ease assembly.

Position the lip of the oil seal (21) as shown in Figure 1, and press it into the bearing retainer. Position the bearing retainer setscrews horizontally inline, and press the retainer into the pedestal bore until it bottoms against the bearing. Use care in sliding the oil seal lip over the end of the shaft.

Install the same thickness of bearing shims as previously removed at disassembly, and install the retainer snap ring. Use a soft-faced mallet to drive the shaft toward the impeller end of the pump and check the shaft end play.

NOTE

The shaft end play should be between .002 to .010 inch.
Add or subtract shims (22) until within specified limits.

Position the slinger ring on the shaft about 1/2 inch from the pedestal and reinstall the shaft key. Lubricate the bearings as indicated in **LUBRICATION**.

Seal Reassembly

Clean the seal cavity, seal clamp, and the impeller shaft with a soft cloth soaked in cleaning solvent.

WARNING

```

////////////////////////////////////
//                               //
// Most cleaning solvents are toxic and flammable. Use //
// them only in a well-ventilated area free from excessive //
// heat, sparks, and flame. Read and follow all prec- //
// autions printed on solvent containers. //
//                               //
////////////////////////////////////

```

The seal is not normally reused since any damage to the precision finished faces could result in premature seal failure. If it is necessary to reuse the old seal in an emergency, **carefully** wash all metallic parts in fresh cleaning solvent and allow them to dry thoroughly.

Handle the seal parts with extreme care to prevent damage to the precision finished faces. Even fingerprints can shorten seal life. Cleanliness is essential.

Inspect the seal components for wear, scoring, grooves, and other damage that might cause leakage. If any components are worn, replace the complete seal; **never mix old and new seal parts.**

If a replacement seal is being used, remove it from the container, and inspect the precision finished faces to ensure that they are free of any foreign matter.

Lubricate the stationary seat O-ring with petroleum jelly or light oil and install it in the stationary seat. Press this assembly squarely into the seal clamp. The polished (lapped) surface should be faced out. Be careful not to damage the seal face.

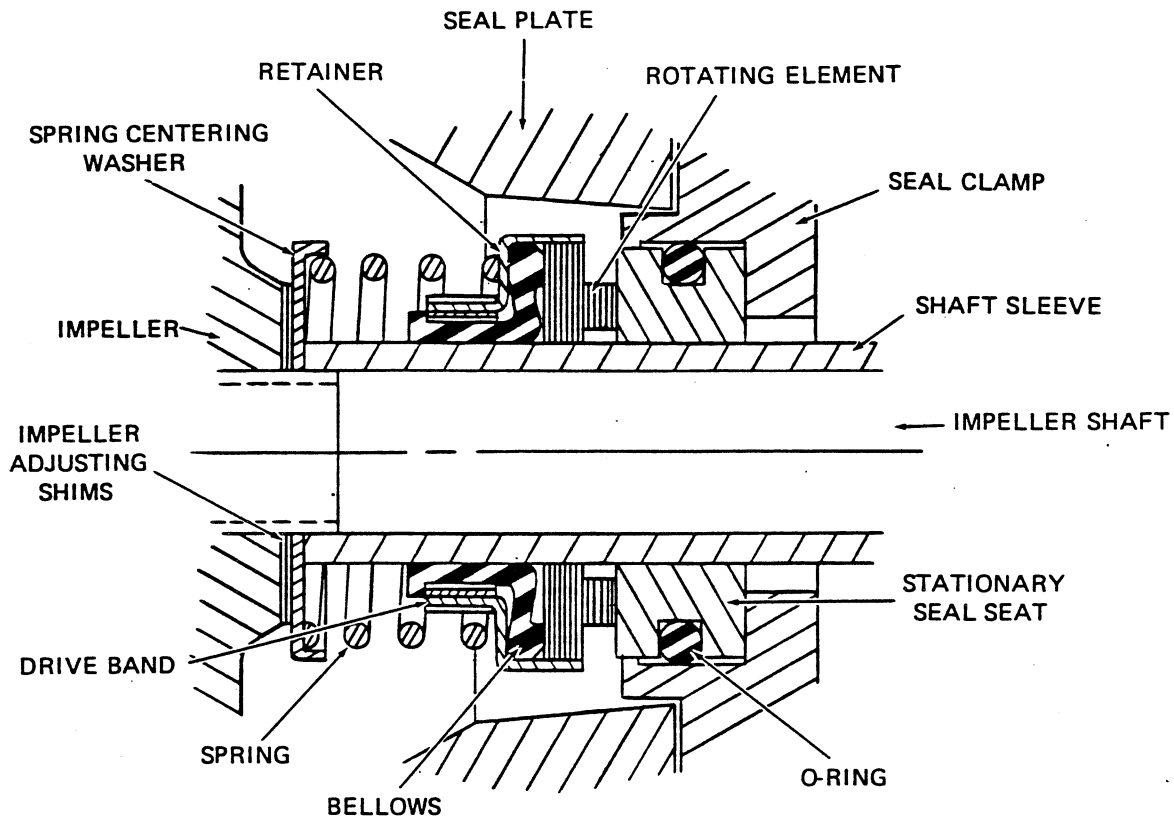

Figure 3. 25271-867 Seal Assembly

CAUTION

This seal is not designed for operation at temperatures above 160°F, or as dictated by the chemical characteristics. Do not use at higher operating temperatures.

Slide the seal clamp (9) along with the seal clamp gasket (30) onto the shaft. Position the seal plate onto the shaft against the pedestal and secure the seal clamp to the seal plate. Temporarily secure the seal plate to the pedestal using two capscrews and nuts (7/16-14 UNC x 1 1/2-inch long, not supplied).

CAUTION

Be certain to reinstall the flat washers (11) under the capscrews when reassembling the seal clamp to the seal plate. Since the threaded inserts are imbedded in plastic, and bolt length is critical, **DO NOT** over tighten or change capscrews length, this may crack the plastic.

Clean and polish the shaft sleeve to remove small scratches and nicks. Replace it if badly worn. **Do not** install at this time.

Lubricate the shaft sleeve with petroleum jelly or light oil and subassemble the seal parts as shown in Figure 3. The rotating seal element must be **just flush** with the chamfered end of the shaft sleeve.

Apply a drop of light oil on each of the precision seal paces, **never** use grease. Slide the sleeve and subassembled seal onto the shaft. Push the sleeve through the seal until the undercut end seats against the shaft shoulder.

Install the spring centering washer.

Pump Reassembly

Inspect the impeller, and replace it if cracked or badly worn.

Install the same number of impeller adjusting shims as previously removed and screw the impeller onto the shaft. Install the impeller washer, and lockwasher, and tighten the impeller capscrew. Remove the two capscrews temporarily holding the seal plate. Replace the pump casing O-ring (33) and reassemble the pump casing to the seal plate and pedestal assembly. Secure the pedestal foot (32) to the pump.

CAUTION

Be certain to reinstall the lockwashers (8 and 31) under the capscrews (7 and 30) when reassembling the pump. The threaded inserts are imbedded in plastic, and bolt length is critical. Install the two longer capscrews (30) in the bottom of the pedestal through the pedestal foot (32). Do not overtighten or change capscrew length, this may crack the plastic around the inserts. Tighten the capscrews in an alternating pattern to ensure uniform torque.

A clearance of .008 to .015 inch between the impeller and the wear plate is necessary for maximum pump efficiency. To achieve this clearance rotate the impeller shaft by hand. If the impeller binds slightly against the wear plate, separate the pump casing and pedestal assemblies, remove the impeller, and re-

move .010 inch of impeller shims. Reassemble the pump. The clearance between the impeller and the wear plate should now be correct.

If the shaft moves freely when rotated by hand, separate the pump casing and pedestal, remove the impeller, and add another impeller shim. Reassemble the pump and rotate the shaft by hand. Repeat this procedure, adding one shim at a time, until the impeller binds slightly against the wear plate. When this occurs, remove .010 inch of shims as indicated above.

Suction Check Valve Installation

Replace any worn or damaged parts and secure the valve weights to the check valve (44) using the attaching hardware. Position the check valve assembly onto the suction flange. Replace the check valve gasket (45) and secure the flange to the pump casing using the attaching hardware (38 and 50).

Check the operation of the check valve to ensure proper seating and free movement.

Final Pump Reassembly

Be sure the pump is secured to the base and power source.

Seal pipe plugs that were removed with a thin coat of Teflon-based sealant or equivalent.

Install the suction and discharge lines, and open all valves. Make certain that all piping connections are secure.

Be sure the pump has been lubricated, see **LUBRICATION**.

Prime the pump through the discharge port with liquid compatible with that being pumped.

Refer to **OPERATION**, Section C, before putting the pump back into service.

LUBRICATION

Seal Assembly

The seal is lubricated by the medium being pumped.

Bearings

The pedestal was fully lubricated when shipped from the factory. Check the oil level regularly through the sight gauge (26) and maintain it at the mid-point of the gauge.

NOTE

When lubrication is required, remove the air vent (15) and add S.A.E. #30 non-detergent oil. Fill to center of sight gauge.

Under normal operating conditions, drain and refill the pedestal once each year with clean oil. **Do not** over lubricate. Excessive oil could cause preloading and over-heating of the bearings.

For cold weather operation, consult the factory or a lubricant supplier for the recommended grade of oil.

**For U.S. and International Warranty Information,
Please Visit www.grpumps.com/warranty
or call:
U.S.: 419-755-1280
International: +1-419-755-1352**

**For Canadian Warranty Information,
Please Visit www.grcanada.com/warranty
or call:
519-631-2870**