

**INSTALLATION, OPERATION, PARTS LIST,
AND MAINTENANCE MANUAL**

ACDEGH



March 13, 1980

Rev. A



***Engine Driven
Self-Priming
Centrifugal Pump
Model 12D-13***

The title text is centered over a large, hollow outline drawing of the pump's housing. The drawing shows the top and side profiles of the pump, including the inlet and outlet ports.

THE GORMAN-RUPP COMPANY • MANSFIELD, OHIO

GORMAN-RUPP OF CANADA LIMITED • ST. THOMAS, ONTARIO, CANADA

Copyright by the Gorman-Rupp Company

Printed in U.S.A.

This Installation, Operation, and Maintenance Manual is designed specifically to help you get the best performance and longest life from your Gorman-Rupp pump.

This pump is a 10 Series, semi-open impeller, self-priming centrifugal model designed for pumping liquids with specified entrained solids.

If there are any questions regarding the pump which are not covered in this manual or in other literature accompanying the unit, please contact your Gorman-Rupp distributor, or write:

The Gorman-Rupp Company
P.O. Box 1217
Mansfield, Ohio 44902

Gorman-Rupp of Canada Limited
70 Burwell Road
St. Thomas, Ontario N5P 3R7

For information or technical assistance on the power source, contact the power source manufacturer's local dealer or representative.

The following are used to alert maintenance personnel to procedures which require special attention, to those which could damage equipment, and to those which could be dangerous to personnel:

NOTE

Instructions to aid in installation, operation, or maintenance or which clarify a procedure.

CAUTION

Instructions which must be followed to avoid causing damage to the product or other equipment incidental to the installation. These describe the procedure required and the damage which could result from failure to follow the procedure.

WARNING

Instructions which must be followed to avoid causing injury or death to personnel. These describe the procedure required and the injury which could result from failure to follow the procedure.

TABLE OF CONTENTS

| | |
|------------------------|-----------|
| WARNINGS | Section A |
| INSTALLATION | Section B |
| OPERATION | Section C |
| TROUBLESHOOTING | Section D |
| MAINTENANCE AND REPAIR | Section E |
| WARRANTY | |

WARNINGS

THESE WARNINGS APPLY TO ALL ENGINE DRIVEN PUMPS. REFER TO THE MANUAL ACCOMPANYING THE ENGINE BEFORE ATTEMPTING TO START THE ENGINE.

Before attempting to open or service the pump:

1. Familiarize yourself with this manual.
2. Disconnect the power source to ensure that the pump will remain inoperative.
3. Allow the pump to cool if overheated.
4. Vent the pump slowly and cautiously.
5. Close the suction and discharge valves.
6. Check the temperature before opening any covers, plates, or plugs.
7. Drain the pump.

Do not attempt to pump volatile or corrosive materials for which this pump has not been designed.

After the pump has been located in its operating position, make certain that the pump has been secured before attempting to operate it.

Do not operate the pump without shields and/or guards in place over drive shafts, belts and/or couplings, or other rotating parts. Exposed rotating parts can catch clothing, fingers, or tools, causing severe injury to personnel.

Do not operate the pump against a closed discharge valve for long periods of time. This could bring the liquid to a boil, build pressure, and cause the pump to rupture or explode.

Overheated pumps can cause severe burns and injury. If overheating of the pump casing occurs:

1. Stop the pump immediately.
2. Allow the pump to cool.
3. Refer to instructions in this manual before restarting the pump.

Do not remove plates, covers, gauges, pipe plugs, or fittings from an overheated pump. Vapor pressure within the pump can cause parts being disengaged to be ejected with great force. Allow the pump to cool before servicing.

Do not operate an internal combustion engine in an explosive atmosphere. When operating internal combustion engines in an enclosed area, make certain that exhaust fumes are piped to the outside. These fumes contain carbon monoxide, a deadly gas that is colorless, tasteless, and odorless.

Fuel used by internal combustion engines presents an extreme explosion and fire hazard. Make certain that all fuel lines are securely connected and free of leaks. Never refuel a hot or running engine. Avoid overfilling the fuel tank. Always use the correct type of fuel.

Never tamper with the governor to gain more power. The governor establishes safe operating limits that should not be exceeded.

INSTALLATION

Seldom are two pump installations identical. The information presented in this section is a summary of the recommended installation practices related to inspection, pump positioning, hardware, suction and discharge piping, and sumps. For further assistance, contact your Gorman-Rupp distributor or the Gorman-Rupp Company.

PREINSTALLATION INSPECTION

The pump assembly was inspected and tested before it was shipped from the factory. Before installation, inspect the pump for damage which may have occurred during shipment. Check as follows:

- a. Inspect the pump assembly for cracks, dents, damaged threads, and other obvious damage.
- b. Check for and tighten loose bolts, nuts, cap screws, and other attaching hardware. Since gaskets tend to shrink after drying, check for and tighten loose nuts and cap screws securing mating surfaces.
- c. Carefully read all tags, decals, and markings on the pump assembly, and perform all duties indicated. Note the direction of rotation indicated on the pump.
- d. Check all lubricant levels and lubricate as necessary. Refer to the MAINTENANCE AND REPAIR section of this manual.

POSITIONING THE PUMP

Mounting

Locate the pump in an accessible place as close as practical to the liquid to be pumped. Level mounting is essential for proper operation. The pump may have to be supported to provide for level operation or to eliminate vibration.

Lifting**WARNING**

Use lifting and moving equipment in good repair and with adequate capacity to prevent injuries to personnel or damage to equipment. The eye bolt is intended for use in lifting the volute **only**; do not attempt to lift the entire pump by the eye bolt.

Make sure that hoists and other lifting equipment are of sufficient capacity to safely handle the pump assembly. If chains or cables are used, make certain that they are positioned so that they will not damage the pump, and so that the load will be balanced.

CAUTION

The pump assembly can be seriously damaged if the cables or chains used to lift and move the unit are improperly wrapped around it.

SUCTION AND DISCHARGE PIPING**Materials**

Either pipe or hose may be used for suction and discharge lines, but hose used in suction lines must be the rigid-wall, reinforced type to prevent collapse under suction. Using pipe couplings in suction lines is not recommended.

Line Configuration

Keep suction and discharge lines as straight as possible to minimize friction losses. Make minimum use of elbows and fittings, which substantially increase friction loss. If elbows are necessary, use the long-radius type to minimize friction loss.

Connections to Pump

Never pull a pipe line into place by tightening the flange bolts. The connecting flange must be aligned exactly with the pump port. Lines near the pump must be independently supported to avoid strain on the pump which could cause serious vibration, decreased bearing life, and increased shaft and seal wear. Hose-type lines should have supports strong enough to secure the line when it is filled with liquid and under pressure.

Gauges

Most pumps are drilled and tapped for installing discharge pressure and vacuum suction gauges. If these gauges are desired for pumps that are not tapped, drill and tap the suction and discharge lines close to the pump before installing the lines.

SUCTION LINES

To avoid air pockets which could affect pump priming, the suction line must be as short and direct as possible. When operation involves a suction lift, the line must always slope upward to the pump from the source of the liquid being pumped; if the line slopes down to the pump at any point along the suction run, air pockets will be created.

Fittings

Suction lines should be the same size as the pump inlet. If reducers are used in suction lines, they should be the eccentric type, and should be installed with the flat part of the reducers uppermost to avoid creating air pockets. Valves are not normally used in suction lines, but if a valve is used, install it with the stem down or to either side to avoid air pockets.

Strainers

Install a strainer at the end of the suction line to avoid possible clogging or damage to the pump. The total area of the openings in the strainer should be at least three or four times the cross section of the suction line, but no opening should be larger than the solids handling capability of the pump. Clean the strainer regularly during operation.

Sealing

All connections in the suction line should be sealed with pipe dope to ensure an airtight seal. Even a slight leak will affect priming, head, and capacity, especially when operating with a high suction lift. After installation, inspect the suction line carefully for potential leaks.

DISCHARGE LINES

Throttling Valves

If a throttling valve is desired, install it in the discharge line. Use a valve as large as the largest pipe in the line to minimize friction losses. Never install a throttling valve in the suction line.

Check Valves

A check valve in the discharge line is normally recommended, but is not necessary in low discharge head applications.

With high discharge heads, install a throttling valve and a check valve in the discharge line to protect the pump from excessive shock pressure and reverse rotation when it is stopped.

Bypass Lines

If it is necessary to permit the escape of air to atmosphere during initial priming or in the repriming cycle, install a bypass line between the pump and the discharge check valve. The bypass line should be sized so that it does not affect pump discharge capacity.

Either a Gorman-Rupp automatic air release valve—which will automatically open to allow the pump to prime, and automatically close when priming is accomplished—or a hand-operated shutoff valve should be installed in the bypass line.

NOTE

The bypass line may clog frequently, particularly if the valve remains closed. If this condition occurs, either use a larger bypass line or leave the shutoff valve open during the pumping operation.

Do not terminate the discharge line at a level lower than that of the liquid being pumped unless a siphon breaker is used in the line. Otherwise, a siphoning action could result, causing damage to the pump.

SUCTION LINE POSITIONING

The depth of submergence of the suction line is critical to efficient pump operation. Figure 1 shows recommended minimum submergence vs. velocity.

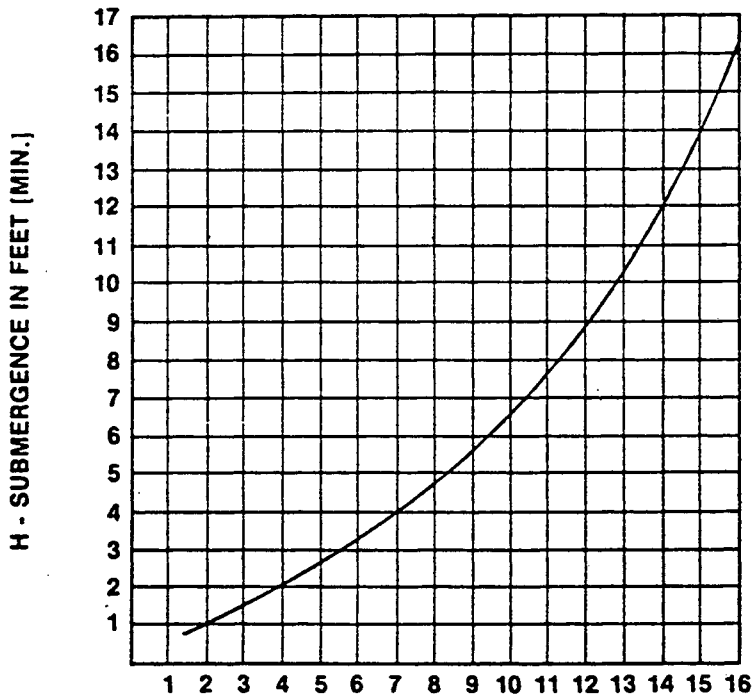

$$\text{VELOCITY IN FEET PER SEC.} = \frac{\text{QUAN. [G.P.M.] x .321}}{\text{AREA}} \quad \text{OR} \quad \frac{\text{G.P.M. x .4085}}{D^2}$$

Figure 1. Recommended Minimum Suction Line Submergence Vs. Velocity

OPERATION

WARNING

Do not attempt to pump volatile or corrosive materials for which this pump has not been designed.

PRIMING

Install the pump and piping as described in INSTALLATION. Make sure that the piping connections are tight, and that the pump is securely mounted. Check that the pump is properly lubricated (see LUBRICATION in MAINTENANCE AND REPAIR).

This pump is self priming, but the pump volute casing must first be filled with liquid if:

1. The pump is being put into service for the first time.
2. The pump has not been used for a considerable length of time.
3. The liquid in the volute casing has evaporated.

Once the volute casing has been filled, the pump will prime and reprime as necessary.

CAUTION

Never operate a self-priming pump unless the volute is filled with liquid. The pump will not prime when dry. Extended operation of a dry pump will destroy the seal assembly.

To fill the pump, remove the volute fill cover or fill plug at the top of the casing and add clean liquid until the pump is filled. Replace the fill cover or fill plug before operating the pump.

STARTING

Consult the operating manual furnished with the power source.

OPERATION

Lines With a Bypass

Either a Gorman-Rupp automatic air release valve or a hand operated shutoff valve may be installed in a bypass line.

If a Gorman-Rupp automatic air release valve has been installed, close the throttling valve in the discharge line. The Gorman-Rupp valve will automatically open to allow the pump to prime, and automatically close when priming has been accomplished. After the pump has been primed, and liquid is flowing steadily from the bypass line, open the discharge throttling valve.

If a hand operated shutoff valve has been installed, close the throttling valve in the discharge line, and open the bypass shutoff valve so that the pump will not have to prime against the weight of the liquid in the discharge line. When the pump has been primed, and liquid is flowing steadily from the bypass line, close the bypass shutoff valve and open the discharge throttling valve.

Lines Without a Bypass

Open all valves in the discharge line and start the power source. Priming is indicated by a positive reading on the discharge pressure gauge or by quieter operation. The pump may not prime immediately because the suction line must first fill with liquid. If the pump fails to prime within five minutes, stop it and check the suction line for leaks.

After the pump has been primed, partially close the discharge line throttling valve in order to fill the line slowly and guard against excessive shock pressure which could damage pipe ends, gaskets, sprinkler heads, and any other fixtures connected to the line. When the discharge line is completely filled, adjust the throttling valve to the required discharge flow rate.

Leakage

No leakage should be visible at pump mating surfaces, or at pump connections or fittings. Keep all line connections and fittings tight to maintain maximum pump efficiency.

Overheating

Overheating can occur if the valves in the suction or discharge lines are closed. Operating against closed valves could bring the liquid to a boil, build pressure, and cause the pump to rupture or explode. If overheating occurs, stop the pump and allow it to cool before servicing it. Refill the volute casing with cool liquid.

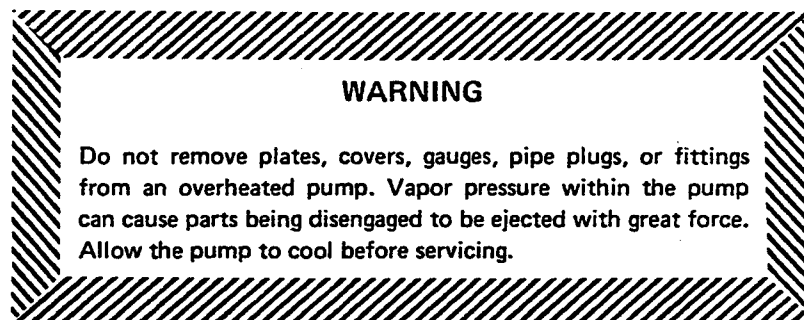

Strainer Check

Check the suction strainer regularly during pump operation, or if the pump flow rate begins to drop, and clean it as necessary. Be especially alert for unusual noises when pumping liquids containing solids.

Pump Vacuum Check

Install a vacuum gauge in the system, using pipe dope on the threads.

The pump should pull a vacuum of 20 inches or more of mercury at operating speed with the suction line blocked. If it does not, check for air leaks in the seals or gaskets.

With the pump primed and at operating speed, and the suction line open, read the vacuum gauge. Shut off the pump, keep the vacuum line open, and read the gauge again to see if the vacuum remains at the maximum developed by the pump. If the vacuum falls off rapidly, an air leak exists. If the liquid level at the source of supply remains at a constant level, check to make certain that the air leak is not from the vacuum gauge connection.

STOPPING

After stopping the pump, disconnect the power source to ensure that the pump will remain inoperative.

In below freezing conditions, drain the pump to prevent damage from freezing. Also, clean out any solids by flushing with a hose. Operate the pump for approximately one minute; this will remove any remaining liquid that could freeze the pump rotating parts.

If the pump will be idle for more than a few hours, or if it has been pumping liquids containing a large amount of solids, drain the pump, and flush it thoroughly with clean water. To prevent large solids from clogging the drain port and preventing the pump from completely draining, operate the pump during the draining process. Clean out any remaining solids by flushing with a hose.

TROUBLESHOOTING

WARNING

Before attempting to open or service the pump:

1. Consult pump service manual.
2. Disconnect the power source to ensure that the pump will remain inoperative.
3. Allow pump to cool if overheated.
4. Close suction and discharge valves.
5. Drain pump.

| Trouble | Possible Cause | Probable Remedy |
|---|---|--|
| PUMP FAILS TO PRIME | <p>Air leak in suction line.</p> <p>Lining of suction hose collapsed.</p> <p>Suction check valve clogged or binding.</p> <p>Leaking or worn seal or pump gasket.</p> <p>Suction lift or discharge head too high.</p> <p>Suction strainer clogged.</p> | <p>Correct leak.</p> <p>Replace suction hose.</p> <p>Clean valve.</p> <p>Check pump vacuum. Replace leaking or worn seal or gasket.</p> <p>Check piping installation and install bypass line if needed. See INSTALLATION.</p> <p>Clean suction strainer.</p> |
| PUMP STOPS OR FAILS TO DELIVER RATED FLOW OR PRESSURE | <p>Air leak in suction line.</p> <p>Suction intake not submerged at proper level or sump too small.</p> <p>Lining of suction hose collapsed.</p> <p>Impeller or other wearing parts worn or damaged.</p> <p>Impeller clogged.</p> <p>Pump speed too slow.</p> <p>Discharge head too high.</p> <p>Suction lift too high.</p> | <p>Correct leak.</p> <p>Check installation and correct as needed. Check submergence chart (Section B, page 4).</p> <p>Replace suction hose.</p> <p>Check impeller clearance. Replace worn parts as needed.</p> <p>Free impeller of debris.</p> <p>Check driver output.</p> <p>Install bypass line.</p> <p>Reduce suction lift.</p> |

| Trouble | Possible Cause | Probable Remedy |
|---|---|---|
| <p>PUMP STOPS OR FAILS TO DELIVER RATED FLOW OR PRESSURE (cont)</p> | <p>Leaking or worn seal or pump gaskets.</p> <p>Suction strainer clogged.</p> | <p>Check pump vacuum. Replace leaking or worn seal or pump gaskets.</p> <p>Clean suction strainer.</p> |
| <p>PUMP REQUIRES TOO MUCH POWER</p> | <p>Pump speed too high.</p> <p>Discharge head too low.</p> <p>Liquid solution too thick.</p> | <p>Reduce speed of power source.</p> <p>Adjust discharge valve.</p> <p>Dilute if possible.</p> |
| <p>PUMP CLOGS FREQUENTLY</p> | <p>Discharge flow too slow.</p> <p>Suction check valve clogged or binding.</p> | <p>Open discharge valve fully to increase flow rate, and run engine at maximum governed speed.</p> <p>Free valve, and clean or replace it.</p> |
| <p>EXCESSIVE NOISE</p> | <p>Cavitation in pump.</p> <p>Pumping entrained air.</p> <p>Pump or drive not securely mounted.</p> <p>Impeller clogged or damaged.</p> | <p>Reduce suction lift and/or friction losses in suction line.</p> <p>Locate and eliminate source of air bubble.</p> <p>Secure mounting hardware.</p> <p>Clean out debris; replace damaged parts.</p> |

Engine Driven Self-Priming Centrifugal Pump Model 12D-13

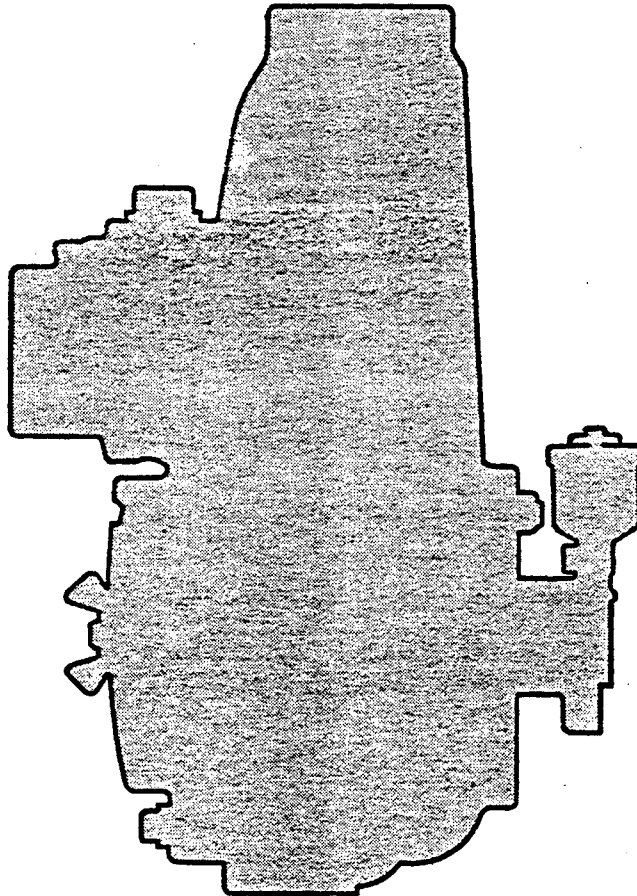

The only moving parts of this pump are the impeller, seal rotating elements, and the shaft. The wear plate, impeller, and seal, which receive the most wear, are easily accessible and can be replaced without disturbing the piping. Maintenance and replacement of these three parts will maintain the peak operating efficiency of the pump.

SECTIONAL DRAWING

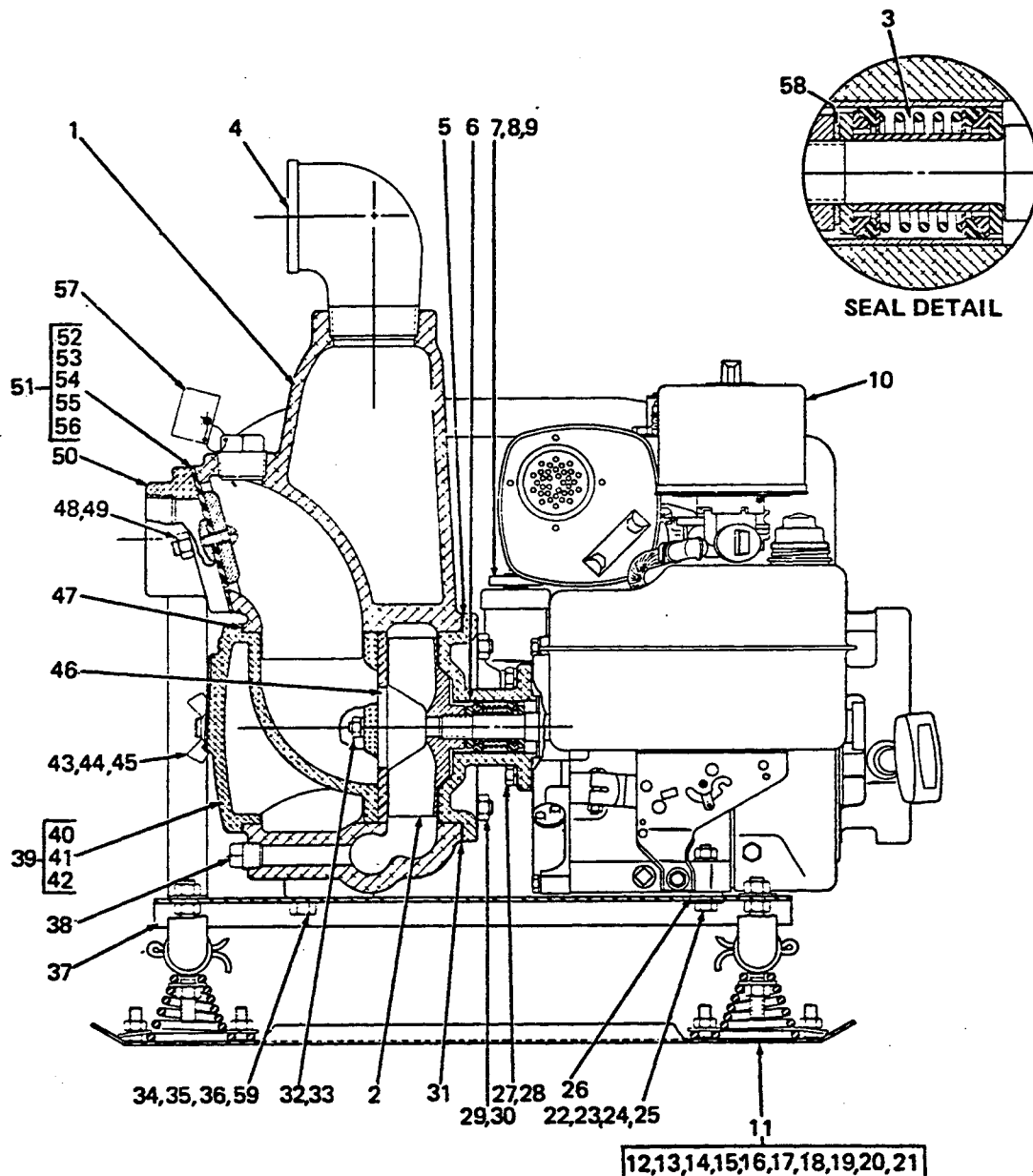

Figure 1. Pump Model 12D-13



PARTS LIST

| ITEM NO. | MODEL 12D-13 PART NAME | PART NUMBER | MATL CODE | NO. REQ |
|----------|----------------------------|-------------|-----------|---------|
| 1 | VOLUTE CASING | 38224-205 | | 1 |
| 2 | ★IMPELLER | 38615-066 | | 1 |
| 3 | ★SEAL ASSEMBLY | GS-625 | | 1 |
| 4 | STREET ELBOW | RS-32 | 11990 | 1 |
| 5 | INTERMEDIATE | 2935 | 13000 | 1 |
| 6 | ★SEAL LINER | 1904 | 14080 | 1 |
| 7 | PIPE NIPPLE | T-0406 | 15070 | 1 |
| 8 | PIPE ELBOW | R-04 | 11990 | 1 |
| 9 | ★SEAL GREASE CUP | S-36 | | 1 |
| 10 | B&S 13 ENGINE | 29112-063 | | 1 |
| 11 | HANDLE KIT ASSY | 48152-003 | | 1 |
| 12 | ASSEMBLY INSTRUCTION SHEET | 14816 | | 1 |
| 13 | MOUNTING SPRING | 1338 | 16030 | 4 |
| 14 | HEX NUT | D-05 | 15991 | 8 |
| 15 | HEX NUT | D-06 | 15991 | 12 |
| 16 | FLAT WASHER | K-05 | 15991 | 8 |
| 17 | FLAT WASHER | K-06 | 15991 | 8 |
| 18 | COTTER PIN | M-0306 | 15990 | 4 |
| 19 | HANDLE | 31971-011 | | 2 |
| 20 | BASE | 41566-005 | | 2 |
| 21 | MOUNTING TUBE ASSEMBLY | 44723-015 | | 2 |
| 22 | HEX HD CAP SCREW | B-0507 | 15991 | 2 |
| 23 | FLAT WASHER | K-05 | 15991 | 2 |
| 24 | LOCKWASHER | J-05 | 15991 | 2 |
| 25 | HEX NUT | D-05 | 15991 | 2 |
| 26 | SPACER BLOCK | 31412-028 | | 2 |
| 27 | HEX HD CAP SCREW | B-0503½S | 15991 | 4 |
| 28 | LOCKWASHER | J-05 | 15991 | 4 |
| 29 | STUD | C-0605½ | 15991 | 4 |
| 30 | HEX NUT | D-06 | 15991 | 4 |
| 31 | ★VOLUTE GASKET SET | 504-G | 18000 | 1 |

| ITEM NO. | MODEL 12D-13 PART NAME | PART NUMBER | MATL CODE | NO. REQ |
|------------|--------------------------|-------------|-----------|---------|
| 32 | LOCKWASHER | J-04 | 15991 | 2 |
| 33 | HEX NUT | D-04 | 15991 | 2 |
| 34 | HEX HD CAP SCREW | B-0606 | 15991 | 2 |
| 35 | LOCKWASHER | J-06 | 15991 | 2 |
| 36 | HEX NUT | D-06 | 15991 | 2 |
| 37 | BASE CHANNEL | 7425 | 15990 | 2 |
| 38 | VOLUTE DRAIN PLUG | P-06 | 11990 | 1 |
| 39 | COVER PLATE ASSY | 42111-920 | | 1 |
| 40 | WARNING PLATE | 2613-EV | 13990 | 1 |
| 41 | ★COVER PLATE | 13305-A | 13040 | 1 |
| 42 | DRIVE SCREW | BM#04-03 | 15990 | 4 |
| 43 | STUD | C-0808 | 15991 | 2 |
| 44 | FLAT WASHER | KE-08 | 15991 | 2 |
| 45 | WING NUT | BB-08 | 15990 | 2 |
| 46 | ★WEAR PLATE | 46451-018 | | 1 |
| 47 | ★COVER PLATE GASKET | 12369-G | 20000 | 1 |
| 48 | STUD | C-0606 | 15991 | 2 |
| 49 | HEX NUT | D-06 | 15991 | 2 |
| 50 | SUCTION FLANGE | 38645-024 | | 1 |
| 51 | ★FLAP VALVE ASSY | 46413-028 | | 1 |
| 52 | ★FLAP VALVE WT | 19-B | 10010 | 1 |
| 53 | ★FLAP VALVE WT | 1354 | 10010 | 1 |
| 54 | LOCKWASHER | J-04 | 17090 | 1 |
| 55 | ROUND HEAD MACHINE SCREW | X-0403 | 17090 | 1 |
| 56 | ★FLAP VALVE | 38671-630 | | 1 |
| 57 | FILL PLUG ASSY | 48271-063 | | 1 |
| 58 | ★IMPELLER SHIM SET | 513-A | 17090 | 1 |
| 59 | FLAT WASHER | K-06 | 15991 | 2 |
| NOT SHOWN: | | | | |
| | DRIVE SCREW | BM#04-03 | 15990 | 4 |
| | NAMEPLATE | 2613-AY | 13990 | 1 |
| | STRAINER | 9026-D | 24000 | 1 |

★ Indicates parts recommended for stock
 Note: This parts list applies to pumps from serial no. 707390
 Above serial numbers do not apply to pumps made in Canada.

CANADIAN SERIAL NO. AND UP



PUMP AND SEAL DISASSEMBLY AND REASSEMBLY

This pump requires little service due to its rugged, minimum-maintenance design. If it becomes necessary to inspect and/or replace the wearing parts, however, follow these instructions, which are keyed to the sectional view (see figure 1) and the accompanying parts list.

Pump Disassembly

Disconnect the spark plug, or take other precautions to ensure that the engine will remain inoperative while the pump is being serviced, and close all connecting valves. Remove the volute drain plug (38) to drain the pump.

Support the pump body, and remove the hex nuts (30) securing the volute casing (1) to the intermediate (5). Separate the two assemblies. Inspect the wear plate (46), and replace it if scored or worn.

To loosen the impeller (2), tap the vanes in the direction of pump rotation with a block of wood or a soft-faced mallet or hammer. Unscrew the impeller, and replace it if cracked or badly worn.

Remove the impeller adjusting shims (58). For ease of reassembly, tag and tie the shims, or measure and record their thickness.

Seal Disassembly

Before removing the seal assembly, turn the cross arm on the seal grease cup (9) clockwise until it rests against the cover (see figure 3). This will prevent the grease in the cup from escaping after the seal is removed.

Carefully remove the shaft sleeve and the stationary and rotating seal elements, using a stiff wire with a hooked end if necessary. Remove the seal liner (6), which is a press fit.

Clean the seal cavity and shaft with a soft cloth soaked in cleaning solvent.

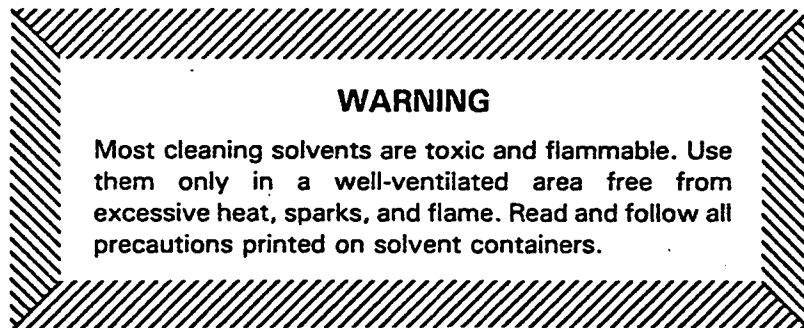

Seal Reassembly

The seal is not normally reused because of the high polish on its lapped faces, but if it is necessary to reuse the old seal, wash all metallic parts in cleaning solvent and dry thoroughly

Inspect the seal components for wear, scoring, grooves, and other damage that might cause leakage. If any components are worn, replace the complete seal; never mix old and new seal parts. Clean and polish the shaft sleeve, or replace it if there are nicks or cuts on the end.

Replace the seal liner if worn or grooved. If the seal liner is replaced, a hole must be drilled in it after installation to permit the flow of lubricant from the grease cup to the seal assembly. Deburr the hole after drilling, and clean the seal liner.

CAUTION

This seal is not designed for operation at temperatures above 110°F. Do not use at higher operating temperatures.

Reinstall the shaft sleeve, and install the replacement seal as a complete unit.

Lubricate the packing rings with soft grease or oil when installing the seal, and place a drop of light lubricating oil on the lapped faces. Assemble the seal as shown in figure 2.

Before starting the pump, fill the grease cup through the grease fitting with a good grade of No. 2 pressure gun grease until grease escapes from the relief hole. Turn the grease cup arm counterclockwise until it is at the top of the stem; this will release the spring to apply grease to the seal (see figure 3).

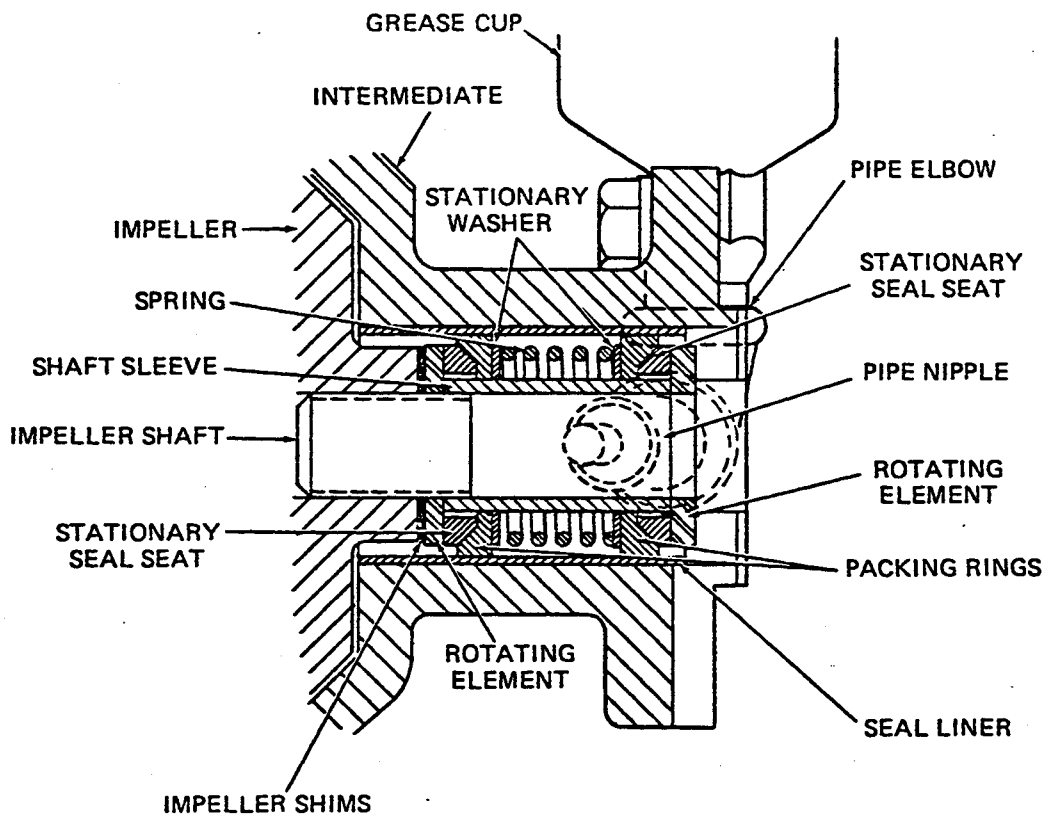

Figure 2. GS-625 Seal Assembly

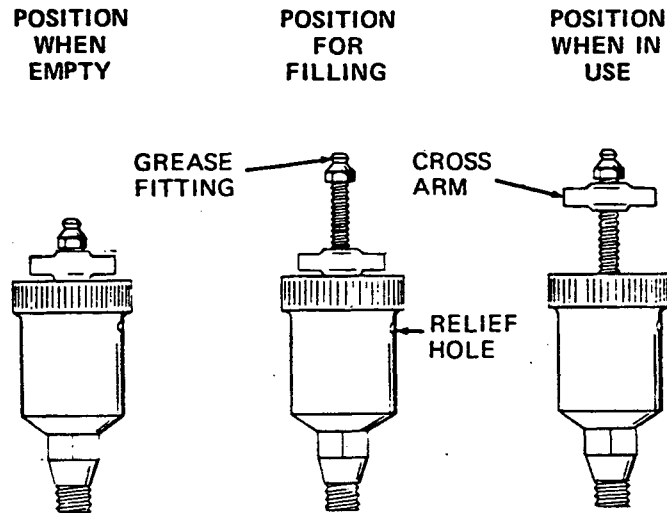

Figure 3. Automatic Lubricating Grease Cup

Pump Reassembly

Reinstall the impeller adjusting shims and the impeller. A clearance of .015 to .030 inch between the impeller and the intermediate is necessary for maximum pump efficiency. Measure this clearance, and add or subtract impeller shims until it is reached.

Reassemble the volute casing to the intermediate, replacing the volute gasket set. A clearance of .010 to .020 inch between the impeller and the wear plate is also recommended for maximum pump efficiency. This clearance can be reached by adding or subtracting gaskets in the volute gasket set until the impeller binds against the wear plate when the shaft is turned by hand. After the impeller binds, add .015 inch of gaskets.

Before starting the pump, clean and reinstall the volute drain plug, and fill the volute with liquid.

**For U.S. and International Warranty Information,
Please Visit www.grpumps.com/warranty
or call:
U.S.: 419-755-1280
International: +1-419-755-1352**

**For Canadian Warranty Information,
Please Visit www.grcanada.com/warranty
or call:
519-631-2870**